



# EUROLAMP®

Pioneers in New Technology !

20  
20

ΚΑΤΑΛΟΓΟΣ ΛΑΜΠΤΗΡΩΝ & ΦΩΤΙΣΜΟΥ  
BULB'S & LIGHTING CATALOGUE



# EUROLAMP®

Pioneers in New Technology !

- ΣΤΟΙΧΕΙΑ ΤΡΑΠΕΖΙΚΩΝ ΛΟΓΑΡΙΑΣΜΩΝ EUROLAMP ABEE
- EUROLAMP SA BANKING ACCOUNTS

**ΕΘΝΙΚΗ ΤΡΑΠΕΖΑ:** 224/470122-40  
IBAN: GR79 0110 2240 0000 2244 7012 240

**ΕΘΝΙΚΗ ΤΡΑΠΕΖΑ:** 840/470602-19  
IBAN: GR4801108400000084047060219

**ΤΡΑΠΕΖΑ ΠΕΙΡΑΙΩΣ:** 5229 – 063351 – 500  
IBAN : GR26 0172 2290 0052 2906 3351 500

**ALPHA BANK:** 703 00 2002 016002  
IBAN : GR86 0140 7030 7030 0200 2016 002

**EUROBANK:** 0026.0216.91.0200622333  
IBAN: GR72 0260 2160 0009 1020 0622 333

- ΣΤΟΙΧΕΙΑ ΤΡΑΠΕΖΙΚΩΝ ΛΟΓΑΡΙΑΣΜΩΝ ΒΕΛΓΙΟΥ:  
EUROLAMP BELGIUM SPRL

- EUROLAMP BELGIUM SPRL BANKING ACCOUNTS

Beneficiary Name : EUROLAMP BELGIUM SPRL  
Beneficiary Address: 829, Chaussee De Marche BTE2 B-5100  
WIERDE BELGIUM  
**BANK: AXA BANK BELGIUM**  
IBAN ACCOUNT : BE87751207895894  
BIC: AXABBE22

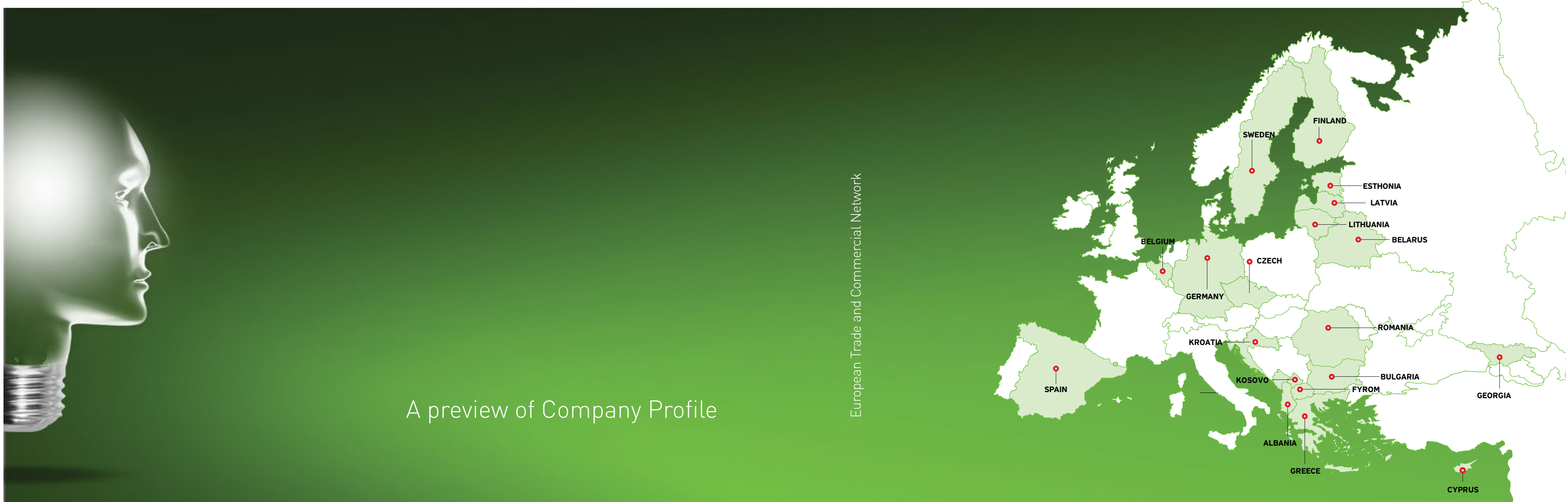

## A preview of Company Profile

**EUROLAMP SA** company was established in 2000 and has its premises in Thessaloniki.

Its increasing route started very early. Initially, only inside Greek territory with items of Lighting and Electrical Equipment.

Then, evolving and constantly worried, by widening its horizons and its products variety, has managed to belong to the leaders of the sector.

Today, as a Leader in **Lighting Technology, Electrical Equipment and Christmas Decoration** items activates in the whole Greek territory as well as in many Balkan and European Union countries. With long lasting and full experience in Production Supervision but also in Trade and Import sector, ensures you directly the supply of :

- **Bulbs and Lighting items of all Technologies,**  
for every domestic and professional demanding use.
- **Electrical Equipment and Accessories,**  
consumables for every domestic and professional need.
- **Christmas Lighting and Decoration Items,**  
with brand name "Magic Christmas" and to a replete codes' variety
- **Electrical Domestic Appliances,**  
such as Heaters, Fans, Dehumidifiers, Air coolers, Insect Repellents and a multitude of other Small Appliances
- **Batteries,**  
for every electric or electronic appliance of domestic use

furthermore, organizes and cares for the whole Production Process of your Private Label (Private Label Production).

Remaining faithfull in its worldview and always in a developing pathway searches, designs and chooses carefully, so as to offer always to its clients...

**the best !**

### EUROLAMP GREECE SA

Diavata Ionia ,  
Thessaloniki Greece P.C 57008  
Tel: 0030 2310 574802  
Fax: 0030 2310 574919  
Site: [www.eurolamp.gr](http://www.eurolamp.gr)  
Email: [info@eurolamp.gr](mailto:info@eurolamp.gr)

### EUROLAMP BELGIUM SPRL

829,B2 Chausse de Marche  
5100 Wierde  
Belgique  
Wallonie +320479172657  
Flandres +320493444162  
email: [info@eurolamp.be](mailto:info@eurolamp.be)

### EUROLAMP CHINA SA

Rm1101-1106. JiuYou Mansion  
No.1158 Hui Highway  
Nanxiang Town, Jiading District  
201800 Shanghai / P.R. China  
Tel.+86-21-64379558  
Fax: +86-21-64722682  
[www.superwayltd.com](http://www.superwayltd.com)

### EUROLAMP LAMPCENTER

Vastra Finbodavagen 2-4  
130 31 Nacka  
Stockholm  
Svergie  
Tel +46864409800  
Fax +4686409820

# QUALITY CLASSIFICATIONS ΔΙΑΒΑΘΜΙΣΕΙΣ ΠΟΙΟΤΗΤΑΣ

PRO  
SERIES

**Υπερ-υψηλή Ποιότητα** και τελευταία τεχνολογία σε επιλεγμένα προϊόντα για επαγγελματική χρήση. Υψηλά standards ασφάλειας, μεγάλη διάρκεια ζωής και Εγγύηση έως 4 έτη.

**Premium Quality** and use of the most recent technological advancements, in a selected group of products that are suitable for professional use. Higher safety standards, a long lasting lifetime and up to 4 years of Warranty.

PLUS  
SERIES

Σειρά καλύτερης ποιότητας, σε μεγάλη γκάμα κωδικών για οικιακές, επαγγελματικές και βιομηχανικές χρήσεις

A Higher Quality series with a wide range of products suitable for domestic, professional and industrial use.

VALUE  
SERIES

Η Κατηγορία περιλαμβάνει προϊόντα οικιακής και εμπορικής χρήσης, υψηλής απόδοσης και χαμηλού κόστους. Με την υποστήριξη της EUROLAMP.

This category consists of high efficiency and low in cost products, that are suitable for general domestic and commercial applications. Supported by EUROLAMP.

• ΠΕΡΙΕΧΟΜΕΝΑ • CONTENTS

• ΤΟΜΕΑΣ ΛΑΜΠΤΗΡΩΝ • BULBS SECTION



**EUROLAMP®**  
PAGES 10 - 11

ΠΡΟΩΘΗΤΙΚΑ ΣΤΑΝΤ  
PROMOTIONAL STANDS  
AAAAAAA



**CROSS Filament**  
PAGES 23

· ΛΑΜΠΤΗΡΕΣ LED FILAMENT CROSSED  
· LED CROSSED FILAMENT BULBS  
ST64-E27



**LEDSMD**  
PAGES 33

· ΛΑΜΠΤΗΡΕΣ ΚΟΙΝΟΙ LED SMD  
· LED SMD BULBS  
T40 - E27



**LEDSMD**  
PAGES 40

· LED SMD GLOBE BULBS  
· ΛΑΜΠΤΗΡΑΣ ΚΟΙΝΟΣ ΓΛΟΜΠΟΣ LED SMD  
R50 / R63 / R80



**LEDSMD**  
PAGES 69

· LED SMD REFRIGERATOR BULBS  
· ΛΑΜΠΤΗΡΕΣ LED SMD ΨΥΓΕΙΟΥ  
T18 / T22 / T23



**LEDSMD**  
PAGES 80 - 81

· LED SMD BULB WITH SOLAR PANEL  
· ΛΑΜΠΤΗΡΑΣ LED SMD ΜΕ ΗΛΙΑΚΟ ΠΑΝΕΛ  
A70 - E27



**CROSS Filament**  
PAGES 16 - 17

· LED FILAMENT CROSSED BULBS  
· ΛΑΜΠΤΗΡΕΣ LED FILAMENT CROSSED  
A60 / A67 - E27 / B22



**Filament**  
PAGES 24 - 25

· LED FILAMENT BULBS  
· ΛΑΜΠΤΗΡΕΣ LED FILAMENT  
A60 - C37 - G45



**LEDSMD**  
PAGES 33

· LED SMD BULBS  
· ΛΑΜΠΤΗΡΕΣ ΚΟΙΝΟΙ LED SMD  
A60 - E27 / 12V-24V · 42V - AC/DC



**TUBULAR LED SMD**  
PAGES 43 - 47

· LED SMD BULBS  
· ΛΑΜΠΤΗΡΕΣ LED SMD  
T5 - 60 - 90 - 120 - 150 CM



**Filament DECORATIVE**  
PAGES 72

· LED FILAMENT BULBS  
· ΛΑΜΠΤΗΡΕΣ LED FILAMENT  
· DIMMABLE · ST64 / G95 / G125 - E27



**LEDSMD**  
PAGES 82 - 83

· ΛΑΜΠΤΗΡΕΣ LED ΕΙΔΙΚΗΣ ΤΕΧΝΟΛΟΓΙΑΣ  
· SPECIAL TECHNOLOGY LED BULBS  
A60 / E27



**CROSS Filament**  
PAGES 18 - 19

· LED FILAMENT CROSSED BULBS  
· ΛΑΜΠΤΗΡΕΣ LED FILAMENT CROSSED  
C37 - E14



**LEDSMD**  
PAGES 28

· LED SMD BULBS  
· ΛΑΜΠΤΗΡΕΣ ΚΟΙΝΟΙ LED SMD  
A60 / A80 / A95 - E27



**LEDSMD**  
PAGES 34 - 36

· LED SMD BULBS  
· ΛΑΜΠΤΗΡΕΣ ΚΟΙΝΟΙ LED SMD  
MINION · C37 F37 - E14



**LEDSMD**  
PAGES 48 - 54

· LED SMD BULBS  
· ΛΑΜΠΤΗΡΕΣ LED SMD  
MR11 / MR16 / GU10 / GU11



**CROSS Filament GOLD GLASS**  
PAGES 72 - 73

· LED FILAMENT CROSSED BULBS  
· ΛΑΜΠΤΗΡΕΣ LED FILAMENT CROSSED  
· DECORATIVE · DIMMABLE / C37 - E14



**LEDSMD**  
PAGES 86 - 89

· LED SMD BULBS · ΛΑΜΠΤΗΡΕΣ LED SMD  
"AJAX" / SL - E27  
"HAMMER" / T80 - E27



**CROSS Filament**  
PAGES 20 - 21

· LED FILAMENT CROSSED BULBS  
· ΛΑΜΠΤΗΡΕΣ LED FILAMENT CROSSED  
G45 / E14 & E27



**LEDSMD**  
PAGES 29

· LED SMD BULBS  
· ΛΑΜΠΤΗΡΕΣ ΚΟΙΝΟΙ LED SMD  
A60 / A80 - B22



**LEDSMD**  
PAGES 37 - 38

· LED SMD MINI GLOBE BULBS  
· ΛΑΜΠΤΗΡΕΣ ΚΟΙΝΟΙ ΣΦΑΙΡΙΚΟΙ LED SMD  
G45 - E27 / E14



**LEDSMD**  
PAGES 56 - 61

· LED SMD BULBS  
· ΛΑΜΠΤΗΡΕΣ LED SMD  
PAR 30/38/56



**GOLD GLASS**  
PAGES 74 - 75

· LED BULBS · ΛΑΜΠΤΗΡΕΣ LED  
· DECORATIVE · GOLD GLASS · DIMMABLE  
· G95 / G125 - E27 · ST64 / G200 / P165 - E27



**LEDSMD**  
PAGES 90 - 93

· LED SMD BULBS · ΛΑΜΠΤΗΡΕΣ LED SMD  
"MAGNOLIA" - E27  
"TOULIP" S280 / S300 - E27 / E40



**CROSS Filament**  
PAGES 22 - 23

· ΛΑΜΠΤΗΡΕΣ LED FILAMENT CROSSED  
· LED CROSSED FILAMENT BULBS  
G95/G125/ST64-E27



**LEDSMD**  
PAGES 30 - 32

· LED SMD BULBS A60 / A65 - E27 / B22  
· DIMMABLE · BLISTER  
· MULTI-PACK · DISPLAY PALLET



**LEDSMD**  
PAGES 39

· LED SMD GLOBE BULBS  
· ΛΑΜΠΤΗΡΑΣ ΚΟΙΝΟΣ ΓΛΟΜΠΟΣ LED SMD  
G95 / G120 - E27

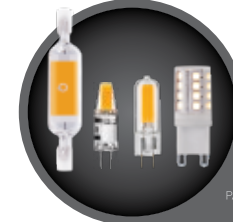

**LEDSMD**  
PAGES 62 - 68

· LED SMD BULBS  
· ΛΑΜΠΤΗΡΕΣ LED SMD  
R7S / G4 / G9



**Vintage Edison**  
PAGES 76

· EDISON BULBS  
· ΛΑΜΠΤΗΡΕΣ ΝΗΜΑΤΟΣ EDISON  
· DECORATIVE · G95 / G125 / ST64 - E27



**HALOGEN BULBS**  
PAGES 96 - 104

· HALOGEN BULBS · ΛΑΜΠΤΗΡ. ΑΛΟΓΟΝΟΥ  
A55 / A60 / G45 / G95  
G4 / G9 / GU10 / R7S / R50 / R63

• ΠΕΡΙΕΧΟΜΕΝΑ • CONTENTS

• ΤΟΜΕΑΣ ΛΑΜΠΤΗΡΩΝ  
• BULBS SECTION

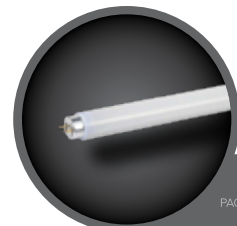

**TUBULAR  
FLUORESCENT**

PAGES 106 - 109

· FLUORESCENT TUBE TRI-PHOSPHOR BULBS  
· ΛΑΜΠΤΗΡΕΣ ΦΘΟΡΙΟΥ  
T8 - G13 · T5 - G5



**HIGH  
PRESSURE  
BULBS**

PAGES 110 - 119

HIGH PRESSURE / METAL HALIDE LAMPS  
ΛΑΜΠΤΗΡΕΣ ΥΨΗΛΗΣ ΠΙΕΣΗΣ - ΜΕΤΑΛΛΟΥ  
PEAR SHAPED / TUBULAR / RX7S / G12



**INCANDESCENT  
BULBS**

PAGES 120 - 124

· INCANDESCENT BULBS  
· ΛΑΜΠΤΗΡΑΣ ΠΥΡΑΚΤΩΣΕΩΣ  
BR38 / PAR38 / A60 / T22 / G45



**INCANDESCENT  
BULBS**

PAGES 125 - 126

· NIGHT LAMPS  
· ΛΑΜΠΑΚΙΑ ΝΥΚΤΟΣ  
E27 / E14 / B22

• ΤΟΜΕΑΣ ΜΠΑΤΑΡΙΩΝ  
• BATTERIES SECTION



**EUROLAMP®**

PAGES 130 - 133

ΜΠΑΤΑΡΙΕΣ EUROLAMP  
EUROLAMP BATTERIES



**Westinghouse**

PAGES 134 - 135

ΜΠΑΤΑΡΙΕΣ WESTINGHOUSE  
WESTINGHOUSE BATTERIES

• ΤΟΜΕΑΣ ΦΑΚΩΝ  
• FLASH LIGHTS SECTION



PAGES 136 - 140

· LED FLASH LIGHTS & LANDERNS  
· ΦΑΚΟΙ & ΦΑΝΑΡΙΑ LED

• ΤΟΜΕΑΣ ΦΩΤΙΣΜΟΥ • LIGHTING SECTION

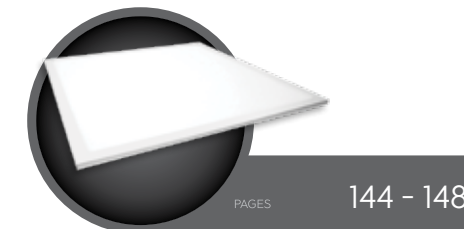

PAGES 144 - 148

· LED LIGHTING PANELS UGR  
· ΦΩΤΙΣΤΙΚΑ ΠΑΝΕΛ LED UGR



PAGES 191 - 208

· PROFESSIONAL LIGHTING INDOOR USE  
· ΕΠΑΓΓΕΛΜΑΤΙΚΟΣ ΦΩΤΙΣΜΟΣ  
ΕΣΩΤΕΡΙΚΟΥ ΧΩΡΟΥ



PAGES 242 - 244

· LED HIGH BAY LIGHTS  
· LED ΦΩΤΙΣΤΙΚΑ ΚΑΜΠΑΝΕΣ

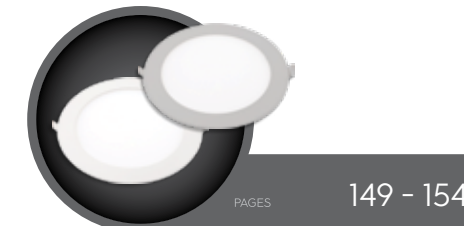

PAGES 149 - 154

· RECESSED LED SLIM LIGHT  
FIXTURES SMD  
· ΦΩΤΙΣΤΙΚΑ ΧΩΝΕΥΤΑ LED SLIM SMD



PAGES 209 - 214

· CEILING SPOTS LED  
· ΣΠΟΤ ΕΣΩΤΕΡΙΚΑ LED



PAGES 245 - 268

· INDOOR LED LIGHTING  
· ΦΩΤΙΣΤΙΚΑ LED ΕΣΩΤΕΡΙΚΟΥ ΧΩΡΟΥ

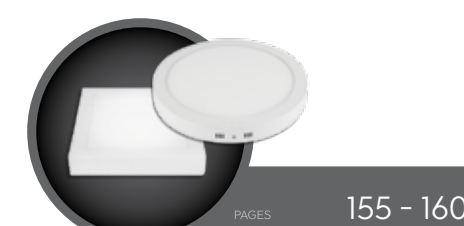

PAGES 155 - 160

· SURFACE LED SLIM LIGHT FIXTURES  
· ΦΩΤΙΣΤΙΚΑ ΕΞΩΤΕΡΙΚΑ LED SLIM

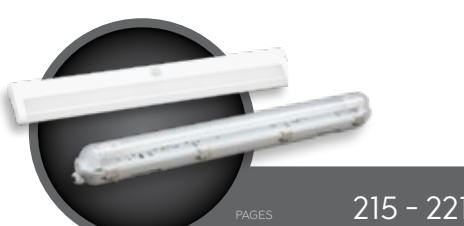

PAGES 215 - 221

· CEILING FLUORESCENT LIGHTS  
· ΦΩΤΙΣΤΙΚΑ ΦΘΟΡΙΟΥ LED



PAGES 269 - 300

· OUTDOOR LED LIGHTING  
· ΦΩΤΙΣΤΙΚΑ LED ΕΞΩΤΕΡΙΚΟΥ ΧΩΡΟΥ



PAGES 161 - 186

· LED TAPES, DRIVERS, CONTROLLERS  
· ΤΑΙΝΙΕΣ LED, ΤΡΟΦΟΔΟΤΙΚΑ,  
CONTROLLER



PAGES 222 - 231

· LED FLOOD LIGHTS  
· ΠΡΟΒΟΛΕΙΣ LED

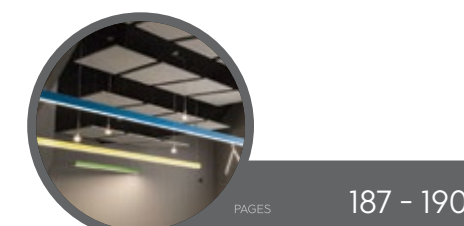

PAGES 187 - 190

· LED LINEAR LIGHTING INDOOR USE  
· ΓΡΑΜΜΙΚΟΣ ΦΩΤΙΣΜΟΣ  
ΕΣΩΤΕΡΙΚΟΥ ΧΩΡΟΥ



PAGES 232 - 241

· STREET LIGHTS  
· ΦΩΤΙΣΤΙΚΑ ΔΡΟΜΟΥ



147-99946  
LED FILAMENT BULBS STAND  
(HANGED COLOR BOX)

- 32 cm
- ↑ 171 cm
- ↗ 42 cm



147-99946  
LED SMD BULBS STAND  
(COLOR BOX)

- 32 cm
- ↑ 171 cm
- ↗ 42 cm



147-99947  
LED FILAMENT BULBS STAND  
(BLISTER)

- 49 cm
- ↑ 189 cm
- ↗ 45 cm



147-99804  
LED SMD BULBS STAND  
(COLOR BOX)

- 53 cm
- ↑ 175 cm
- ↗ 33 cm



147-99806  
BATTERIES STAND  
(BLISTER & BOXES)

- 41.5 cm
- ↑ 162 cm
- ↗ 32 cm



147-99807  
PRODUCTS STAND

- 60 cm
- ↑ 85 cm
- ↗ 80 cm

## EUROLAMP Promotional Products Stands

Η **EUROLAMP**, μπορεί να σας διαθέσει μια σειρά από Προωθητικά Σταντ Προϊόντων, κομψά και λειτουργικά, κατάλληλα για κάθε επαγγελματικό χώρο. Η διάθεση τους προϋποθέτει ελάχιστη ποσότητα παραγγελίας προϊόντων. Για περισσότερες πληροφορίες παρακαλούμε απευθυνθείτε στον πωλητή που σας εξυπηρετεί.

**EUROLAMP** is able to provide you with a wide range of Promotional Product Stands, smart and practical, suitable for all business facilities with minimum order quantity supply requirements. For more information please contact our associate sales representative.

**ΣΗΜΕΙΩΣΗ / NOTE:**

Αυτός ο κατάλογος είναι διαχωρισμένος σε δύο τομείς:

/ Στον τομέα των **Λαμπτήρων**

/ Στον τομέα του **Φωτισμού**

This Catalog divided in two sections:

/ **Bulb's** Section

/ **Lighting** Section

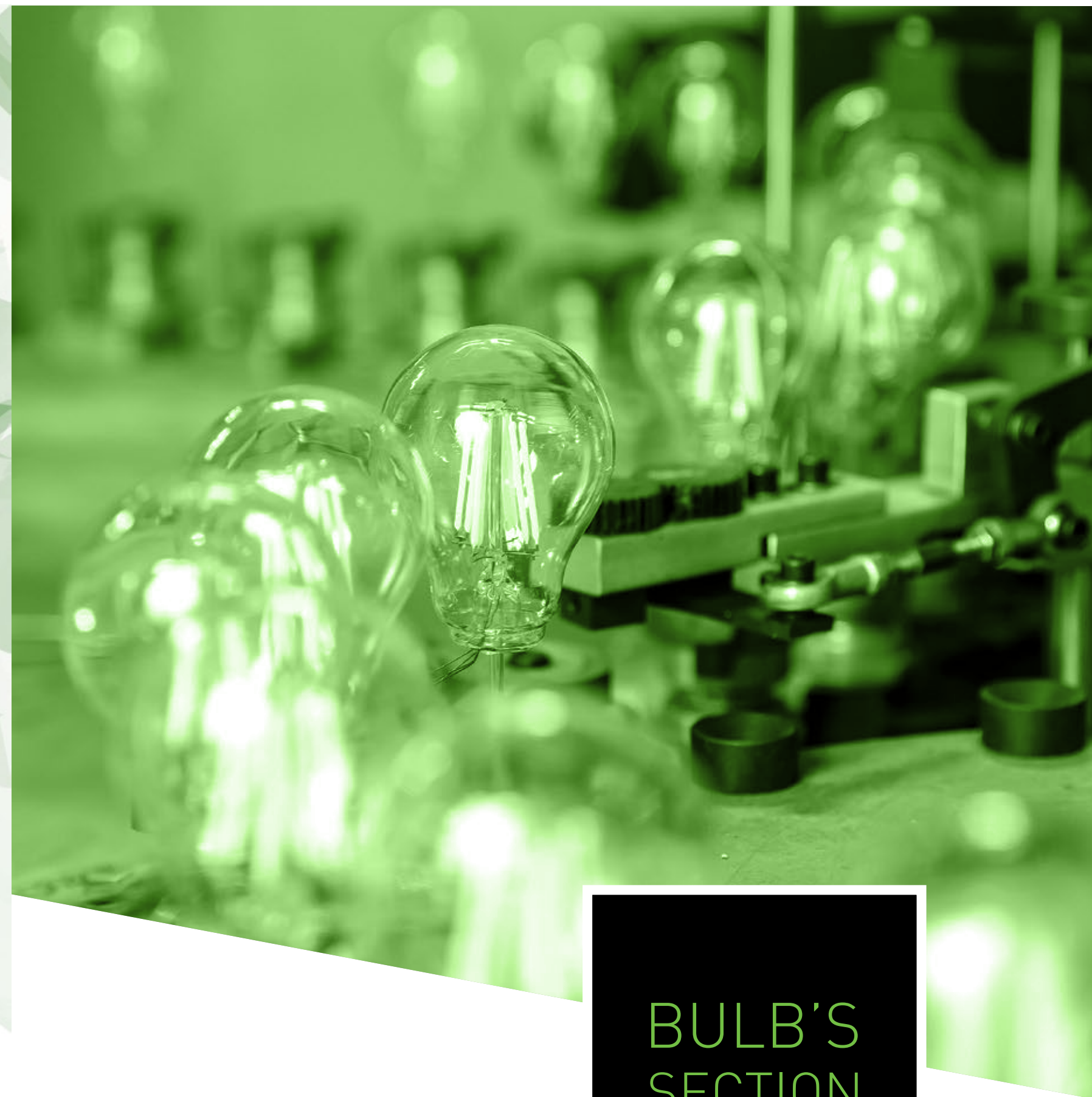

**BULB'S  
SECTION**

ST64 / E27 • CLEAR

A60-A67 / E27 • CLEAR

A60-A67 / E27 • FROST

A60 / E27 • GOLD CLASS

A60-A67 / B22 • CLEAR

C37 / E14 • CLEAR

C37 / E14 • FROST

C37 / E14 • GOLD CLASS

G45 / E14 • CLEAR

G45 / E14 • FROST

G45 / E27 • CLEAR

G45 / E27 • FROST

G95 / E27 • CLEAR

G95 / E27 • MILKY

G125 / E27 • MILKY



Αυτός ο λαμπτήρας υποστηρίζει τιμή του Δείκτη **CRI>90** και προσφέρει την πιο ρεαλιστική απόδοση χρωμάτων σε σχέση με τους απλούς λαμπτήρες Filament. Επιπλέον, προσφέρει **υψηλότερη ποιότητα φωτισμού** χωρίς σκιές και αντανακλάσεις.

This bulb supports a rate indicator **CRI>90** and provides a genuine color yield in relation to ordinary Filament bulbs. Furthermore, it offers **high quality lighting** neutralizing shadows and reflections.

**CROSS**  
Filament

Types: A / C / G

**LED**

Filament Decorative Bulbs

Discover our Collection ►

- LED FILAMENT CROSSED BULBS
- ΛΑΜΠΤΗΡΕΣ LED FILAMENT CROSSED  
A60 / A67 - E27



PRODUCTION MATERIAL: **GLASS WITH ALUMINIUM BASE**  
ΥΛΙΚΟ ΚΑΤΑΣΚΕΥΗΣ: **ΓΥΑΛΙ ΜΕ ΒΑΣΗ ΑΛΟΥΜΙΝΙΟΥ**

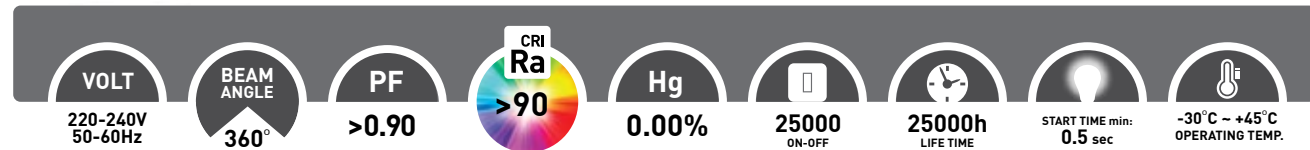

| BARCODE       | CODE      | BASE | TYPE | WATT =WATT | KELVIN | LUMEN | mm     | PACKING | PRICE (€) |
|---------------|-----------|------|------|------------|--------|-------|--------|---------|-----------|
| 5207227030963 | 147-78001 | E27  | A60  | 4.5W 40W   | 6500K  | 480   | 60 106 | 1/10/50 | 3.40      |
| 5207227030970 | 147-78002 | E27  | A60  | 7W 60W     | 6500K  | 806   | 60 106 | 1/10/50 | 4.60      |
| 5207227037429 | 147-78003 | E27  | A60  | 9W 75W     | 6500K  | 1055  | 60 106 | 1/10/50 | 5.10      |
| 5207227030987 | 147-78005 | E27  | A67  | 11W 105W   | 6500K  | 1600  | 67 121 | 1/10/50 | 6.80      |
| 5207227037436 | 147-78011 | E27  | A60  | 4.5W 40W   | 4000K  | 480   | 60 106 | 1/10/50 | 3.40      |
| 5207227030994 | 147-78012 | E27  | A60  | 7W 60W     | 4000K  | 806   | 60 106 | 1/10/50 | 4.60      |
| 5207227037450 | 147-78013 | E27  | A60  | 9W 75W     | 4000K  | 1055  | 60 106 | 1/10/50 | 5.10      |
| 5207227031007 | 147-78015 | E27  | A67  | 11W 105W   | 4000K  | 1600  | 67 121 | 1/10/50 | 6.80      |
| 5207227031052 | 147-78031 | E27  | A60  | 4.5W 40W   | 3000K  | 480   | 60 106 | 1/10/50 | 3.40      |
| 5207227031069 | 147-78032 | E27  | A60  | 7W 60W     | 3000K  | 806   | 60 106 | 1/10/50 | 4.60      |
| 5207227031076 | 147-78033 | E27  | A60  | 9W 75W     | 3000K  | 1055  | 60 106 | 1/10/50 | 5.10      |
| 5207227031083 | 147-78035 | E27  | A67  | 11W 105W   | 3000K  | 1600  | 67 121 | 1/10/50 | 6.80      |
| 5207227031014 | 147-78021 | E27  | A60  | 4.5W 40W   | 2700K  | 480   | 60 106 | 1/10/50 | 3.40      |
| 5207227031021 | 147-78022 | E27  | A60  | 7W 60W     | 2700K  | 806   | 60 106 | 1/10/50 | 4.60      |
| 5207227031038 | 147-78023 | E27  | A60  | 9W 75W     | 2700K  | 1055  | 60 106 | 1/10/50 | 5.10      |
| 5207227031045 | 147-78025 | E27  | A67  | 11W 105W   | 2700K  | 1600  | 67 121 | 1/10/50 | 6.80      |



| BARCODE       | CODE      | BASE | TYPE | WATT =WATT | KELVIN | LUMEN | mm     | PACKING | PRICE (€) |
|---------------|-----------|------|------|------------|--------|-------|--------|---------|-----------|
| 5207227064401 | 147-78074 | E27  | A60  | 9W 75W     | 6500K  | 1100  | 60 106 | 1/10/50 | 6.80      |
| 5207227031908 | 147-78075 | E27  | A60  | 9W 75W     | 4000K  | 1100  | 60 106 | 1/10/50 | 6.80      |
| 5207227031915 | 147-78076 | E27  | A60  | 9W 75W     | 3000K  | 1100  | 60 106 | 1/10/50 | 6.80      |
| 5207227056949 | 147-78077 | E27  | A67  | 11W 105W   | 6500K  | 1600  | 67 121 | 1/10/50 | 8.50      |
| 5207227056970 | 147-78078 | E27  | A67  | 11W 105W   | 4000K  | 1600  | 67 121 | 1/10/50 | 8.50      |
| 5207227057007 | 147-78079 | E27  | A67  | 11W 105W   | 3000K  | 1600  | 67 121 | 1/10/50 | 8.50      |

- LED FILAMENT CROSSED BULBS
- ΛΑΜΠΤΗΡΕΣ LED FILAMENT CROSSED  
A60 / A67 - E27 - **FROST**



PRODUCTION MATERIAL: **GLASS WITH ALUMINIUM BASE**  
ΥΛΙΚΟ ΚΑΤΑΣΚΕΥΗΣ: **ΓΥΑΛΙ ΜΕ ΒΑΣΗ ΑΛΟΥΜΙΝΙΟΥ**

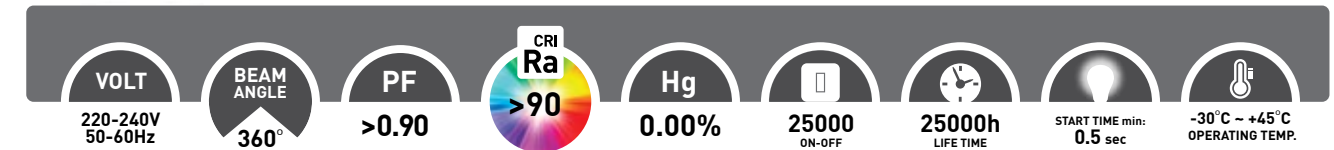

| BARCODE       | CODE      | BASE | TYPE | WATT =WATT | KELVIN | LUMEN | mm     | PACKING | PRICE (€) |
|---------------|-----------|------|------|------------|--------|-------|--------|---------|-----------|
| 5207227031922 | 147-78081 | E27  | A60  | 4.5W 40W   | 6500K  | 480   | 60 106 | 1/10/50 | 3.50      |
| 5207227036132 | 147-78082 | E27  | A60  | 7W 60W     | 6500K  | 806   | 60 106 | 1/10/50 | 4.70      |
| 5207227036149 | 147-78083 | E27  | A60  | 9W 75W     | 6500K  | 1055  | 60 106 | 1/10/50 | 5.20      |
| 5207227064159 | 147-78085 | E27  | A67  | 11W 105W   | 6500K  | 1600  | 67 121 | 1/10/50 | 6.90      |
| 5207227036156 | 147-78091 | E27  | A60  | 4.5W 40W   | 3000K  | 480   | 60 106 | 1/10/50 | 3.50      |
| 5207227036163 | 147-78092 | E27  | A60  | 7W 60W     | 3000K  | 806   | 60 106 | 1/10/50 | 4.70      |
| 5207227036170 | 147-78093 | E27  | A60  | 9W 75W     | 3000K  | 1055  | 60 106 | 1/10/50 | 5.20      |
| 5207227064166 | 147-78095 | E27  | A67  | 11W 105W   | 3000K  | 1600  | 67 121 | 1/10/50 | 6.90      |

- LED FILAMENT CROSSED BULBS
- ΛΑΜΠΤΗΡΕΣ LED FILAMENT CROSSED  
A60 / A67 - B22

PRODUCTION MATERIAL: **GLASS WITH ALUMINIUM BASE**  
ΥΛΙΚΟ ΚΑΤΑΣΚΕΥΗΣ: **ΓΥΑΛΙ ΜΕ ΒΑΣΗ ΑΛΟΥΜΙΝΙΟΥ**

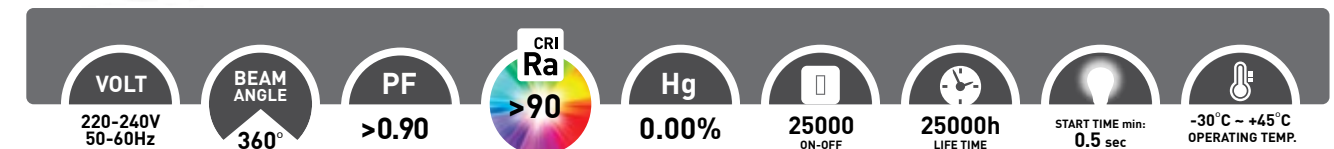

| BARCODE       | CODE      | BASE | TYPE | WATT =WATT | KELVIN | LUMEN | mm     | PACKING | PRICE (€) |
|---------------|-----------|------|------|------------|--------|-------|--------|---------|-----------|
| 5207227031090 | 147-78042 | B22  | A60  | 9W 75W     | 6500K  | 1055  | 60 106 | 1/10/50 | 5.20      |
| 5207227031106 | 147-78043 | B22  | A67  | 11W 105W   | 6500K  | 1600  | 67 121 | 1/10/50 | 6.90      |
| 5207227031113 | 147-78062 | B22  | A60  | 9W 75W     | 3000K  | 1055  | 60 106 | 1/10/50 | 5.20      |
| 5207227031120 | 147-78063 | B22  | A67  | 11W 105W   | 3000K  | 1600  | 67 121 | 1/10/50 | 6.90      |



• LED FILAMENT CROSSED BULBS - C37 - E14  
 • ΛΑΜΠΤΗΡΕΣ LED FILAMENT CROSSED - C37 - E14

PRODUCTION MATERIAL: **GLASS WITH ALUMINIUM BASE**  
 ΥΛΙΚΟ ΚΑΤΑΣΚΕΥΗΣ: **ΓΥΑΛΙ ΜΕ ΒΑΣΗ ΑΛΟΥΜΙΝΙΟΥ**

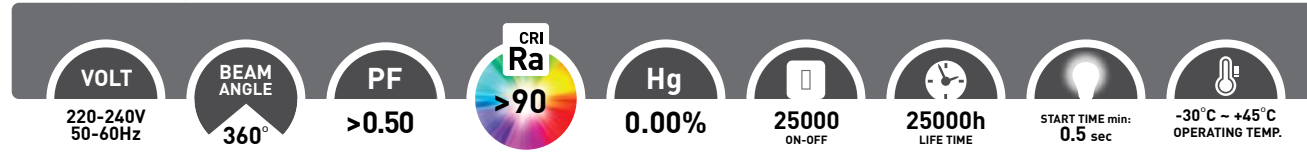

| BARCODE       | CODE      | BASE | TYPE | WATT =WATT | KELVIN | LUMEN | mm    | PACKING | PRICE (€) |
|---------------|-----------|------|------|------------|--------|-------|-------|---------|-----------|
| 5207227036187 | 147-78100 | E14  | C37  | 2.5W 25W   | 6500K  | 250   | 35 98 | 1/10/50 | 2.75      |
| 5207227036194 | 147-78101 | E14  | C37  | 4.5W 40W   | 6500K  | 480   | 35 98 | 1/10/50 | 3.05      |
| 5207227036200 | 147-78102 | E14  | C37  | 6.5W 60W   | 6500K  | 806   | 35 98 | 1/10/50 | 3.80      |
| 5207227036231 | 147-78110 | E14  | C37  | 2.5W 25W   | 4000K  | 250   | 35 98 | 1/10/50 | 2.75      |
| 5207227036248 | 147-78111 | E14  | C37  | 4.5W 40W   | 4000K  | 480   | 35 98 | 1/10/50 | 3.05      |
| 5207227036255 | 147-78112 | E14  | C37  | 6.5W 60W   | 4000K  | 806   | 35 98 | 1/10/50 | 3.80      |
| 5207227036286 | 147-78120 | E14  | C37  | 2.5W 25W   | 3000K  | 250   | 35 98 | 1/10/50 | 2.75      |
| 5207227036293 | 147-78121 | E14  | C37  | 4.5W 40W   | 3000K  | 480   | 35 98 | 1/10/50 | 3.05      |
| 5207227036309 | 147-78122 | E14  | C37  | 6.5W 60W   | 3000K  | 806   | 35 98 | 1/10/50 | 3.80      |
| 5207227036330 | 147-78130 | E14  | C37  | 2.5W 25W   | 2700K  | 250   | 35 98 | 1/10/50 | 2.75      |
| 5207227036347 | 147-78131 | E14  | C37  | 4.5W 40W   | 2700K  | 480   | 35 98 | 1/10/50 | 3.05      |
| 5207227036354 | 147-78132 | E14  | C37  | 6.5W 60W   | 2700K  | 806   | 35 98 | 1/10/50 | 3.80      |



• LED FILAMENT CROSSED BULBS - C37 - E14 - FROST  
 • ΛΑΜΠΤΗΡΕΣ LED FILAMENT CROSSED - C37 - E14 - FROST

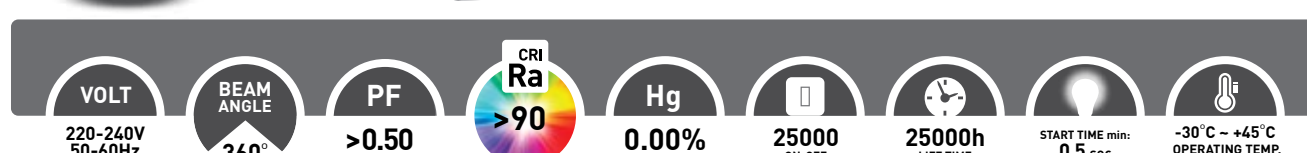

| BARCODE       | CODE      | BASE | TYPE | WATT =WATT | KELVIN | LUMEN | mm    | PACKING | PRICE (€) |
|---------------|-----------|------|------|------------|--------|-------|-------|---------|-----------|
| 5207227036217 | 147-78104 | E14  | C37  | 4.5W 40W   | 6500K  | 480   | 35 98 | 1/10/50 | 3.15      |
| 5207227036224 | 147-78105 | E14  | C37  | 6.5W 60W   | 6500K  | 806   | 35 98 | 1/10/50 | 3.90      |
| 5207227036262 | 147-78114 | E14  | C37  | 4.5W 40W   | 4000K  | 480   | 35 98 | 1/10/50 | 3.15      |
| 5207227036279 | 147-78115 | E14  | C37  | 6.5W 60W   | 4000K  | 806   | 35 98 | 1/10/50 | 3.90      |
| 5207227036316 | 147-78124 | E14  | C37  | 4.5W 40W   | 3000K  | 480   | 35 98 | 1/10/50 | 3.15      |
| 5207227036323 | 147-78125 | E14  | C37  | 6.5W 60W   | 3000K  | 806   | 35 98 | 1/10/50 | 3.90      |
| 5207227036361 | 147-78134 | E14  | C37  | 4.5W 40W   | 2700K  | 480   | 35 98 | 1/10/50 | 3.15      |
| 5207227036378 | 147-78135 | E14  | C37  | 6.5W 60W   | 2700K  | 806   | 35 98 | 1/10/50 | 3.90      |



• LED FILAMENT CROSSED BULBS  
 • ΛΑΜΠΤΗΡΕΣ LED FILAMENT CROSSED  
**DIMMABLE • C37 - E14**

PRODUCTION MATERIAL: **GLASS WITH ALUMINIUM BASE**

ΥΛΙΚΟ ΚΑΤΑΣΚΕΥΗΣ: **ΓΥΑΛΙ ΜΕ ΒΑΣΗ ΑΛΟΥΜΙΝΙΟΥ**

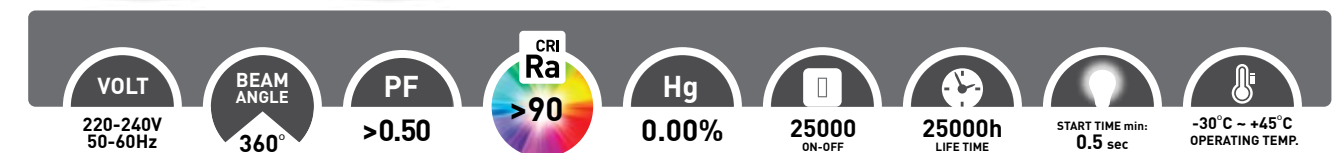

| BARCODE       | CODE      | BASE | TYPE | WATT =WATT | KELVIN | LUMEN | mm     | PACKING | PRICE (€) |
|---------------|-----------|------|------|------------|--------|-------|--------|---------|-----------|
| 5207227064173 | 147-78153 | E14  | C37  | 6.5W 60W   | 6500K  | 806   | 35 98  | 1/10/50 | 5.50      |
| 5207227036385 | 147-78163 | E14  | C37  | 6.5W 60W   | 4000K  | 806   | 35 98  | 1/10/50 | 5.50      |
| 5207227036408 | 147-78173 | E14  | C37  | 6.5W 60W   | 3000K  | 806   | 35 98  | 1/10/50 | 5.50      |
| 5207227073892 | 147-78176 | E14  | F37  | 4.5W 40W   | 2700K  | 480   | 35 119 | 1/10/50 | 4.45      |

• LED FILAMENT CROSSED BULBS • ΛΑΜΠΤΗΡΕΣ LED FILAMENT CROSSED  
**FROST - DIMMABLE • C37 - E14**

PRODUCTION MATERIAL: **GLASS WITH ALUMINIUM BASE**

ΥΛΙΚΟ ΚΑΤΑΣΚΕΥΗΣ: **ΓΥΑΛΙ ΜΕ ΒΑΣΗ ΑΛΟΥΜΙΝΙΟΥ**



| BARCODE       | CODE      | BASE | TYPE | WATT =WATT | KELVIN | LUMEN | mm    | PACKING | PRICE (€) |
|---------------|-----------|------|------|------------|--------|-------|-------|---------|-----------|
| 5207227055812 | 147-78152 | E14  | C37  | 4.5W 40W   | 6500K  | 480   | 35 98 | 1/10/50 | 4.45      |
| 5207227064180 | 147-78154 | E14  | C37  | 6.5W 60W   | 6500K  | 806   | 35 98 | 1/10/50 | 5.60      |
| 5207227055829 | 147-78162 | E14  | C37  | 4.5W 40W   | 4000K  | 480   | 35 98 | 1/10/50 | 4.45      |
| 5207227064197 | 147-78164 | E14  | C37  | 6.5W 60W   | 4000K  | 806   | 35 98 | 1/10/50 | 5.60      |
| 5207227036392 | 147-78172 | E14  | C37  | 4.5W 40W   | 3000K  | 480   | 35 98 | 1/10/50 | 4.45      |
| 5207227064203 | 147-78174 | E14  | C37  | 6.5W 60W   | 3000K  | 806   | 35 98 | 1/10/50 | 5.60      |

- LED FILAMENT CROSSED BULBS
- ΛΑΜΠΤΗΡΕΣ LED FILAMENT CROSSED  
G45 / E14 & E27

**CROSS**  
*Filament*

PRODUCTION MATERIAL: **GLASS WITH ALUMINIUM BASE**  
ΥΛΙΚΟ ΚΑΤΑΣΚΕΥΗΣ: **ΓΥΑΛΙ ΜΕ ΒΑΣΗ ΑΛΟΥΜΙΝΙΟΥ**

WindowPaper  
**Blister**  
PACKING

PLUS  
NOT DIMMABLE  
A++ ENERGY CLASS  
90% ENERGY SAVING  
2 YEARS GUARANTEE

VOLT 220-240V 50-60Hz  
BEAM ANGLE 360°  
PF >0.50  
CRI Ra >90  
Hg 0.00%  
25000 ON-OFF  
25000h LIFETIME  
START TIME min: 0.5 sec  
-30°C ~ +45°C OPERATING TEMP.

| BARCODE       | CODE      | BASE | TYPE | WATT | =WATT | KELVIN | LUMEN | mm    | PACKING | PRICE (€) |
|---------------|-----------|------|------|------|-------|--------|-------|-------|---------|-----------|
| 5207227064210 | 147-78200 | E14  | G45  | 2.5W | 25W   | 6500K  | 250   | 45 78 | 1/10/50 | 2.75      |
| 5207227036415 | 147-78201 | E14  | G45  | 4.5W | 40W   | 6500K  | 480   | 45 78 | 1/10/50 | 3.05      |
| 5207227036422 | 147-78202 | E14  | G45  | 6.5W | 60W   | 6500K  | 806   | 45 78 | 1/10/50 | 3.80      |
| 5207227064227 | 147-78210 | E14  | G45  | 2.5W | 25W   | 4000K  | 250   | 45 78 | 1/10/50 | 2.75      |
| 5207227036439 | 147-78211 | E14  | G45  | 4.5W | 40W   | 4000K  | 480   | 45 78 | 1/10/50 | 3.05      |
| 5207227036446 | 147-78212 | E14  | G45  | 6.5W | 60W   | 4000K  | 806   | 45 78 | 1/10/50 | 3.80      |
| 5207227036453 | 147-78220 | E14  | G45  | 2.5W | 25W   | 3000K  | 250   | 45 78 | 1/10/50 | 2.75      |
| 5207227036460 | 147-78221 | E14  | G45  | 4.5W | 40W   | 3000K  | 480   | 45 78 | 1/10/50 | 3.05      |
| 5207227036477 | 147-78222 | E14  | G45  | 6.5W | 60W   | 3000K  | 806   | 45 78 | 1/10/50 | 3.80      |
| 5207227036491 | 147-78230 | E14  | G45  | 2.5W | 25W   | 2700K  | 250   | 45 78 | 1/10/50 | 2.75      |
| 5207227036507 | 147-78231 | E14  | G45  | 4.5W | 40W   | 2700K  | 480   | 45 78 | 1/10/50 | 3.05      |
| 5207227036514 | 147-78232 | E14  | G45  | 6.5W | 60W   | 2700K  | 806   | 45 78 | 1/10/50 | 3.80      |
| 5207227064234 | 147-78240 | E27  | G45  | 2.5W | 25W   | 6500K  | 250   | 45 78 | 1/10/50 | 2.75      |
| 5207227036521 | 147-78241 | E27  | G45  | 4.5W | 40W   | 6500K  | 480   | 45 78 | 1/10/50 | 3.05      |
| 5207227036538 | 147-78242 | E27  | G45  | 6.5W | 60W   | 6500K  | 806   | 45 78 | 1/10/50 | 3.80      |
| 5207227064241 | 147-78250 | E27  | G45  | 2.5W | 25W   | 4000K  | 250   | 45 78 | 1/10/50 | 2.75      |
| 5207227036545 | 147-78251 | E27  | G45  | 4.5W | 40W   | 4000K  | 480   | 45 78 | 1/10/50 | 3.05      |
| 5207227036552 | 147-78252 | E27  | G45  | 6.5W | 60W   | 4000K  | 806   | 45 78 | 1/10/50 | 3.80      |
| 5207227064258 | 147-78260 | E27  | G45  | 2.5W | 25W   | 3000K  | 250   | 45 78 | 1/10/50 | 2.75      |
| 5207227036569 | 147-78261 | E27  | G45  | 4.5W | 40W   | 3000K  | 480   | 45 78 | 1/10/50 | 3.05      |
| 5207227036576 | 147-78262 | E27  | G45  | 6.5W | 60W   | 3000K  | 806   | 45 78 | 1/10/50 | 3.80      |

- LED FILAMENT CROSSED BULBS
- ΛΑΜΠΤΗΡΕΣ LED FILAMENT CROSSED  
**DIMMABLE** • G45 / E14 & E27

**CROSS**  
*Filament*

PRODUCTION MATERIAL: **GLASS WITH ALUMINIUM BASE**  
ΥΛΙΚΟ ΚΑΤΑΣΚΕΥΗΣ: **ΓΥΑΛΙ ΜΕ ΒΑΣΗ ΑΛΟΥΜΙΝΙΟΥ**

WindowPaper  
**Blister**  
PACKING

PLUS  
NOT DIMMABLE  
A++ ENERGY CLASS  
90% ENERGY SAVING  
2 YEARS GUARANTEE

VOLT 220-240V 50-60Hz  
BEAM ANGLE 360°  
PF >0.50  
CRI Ra >90  
Hg 0.00%  
25000 ON-OFF  
25000h LIFETIME  
START TIME min: 0.5 sec  
-30°C ~ +45°C OPERATING TEMP.

| BARCODE       | CODE      | BASE | TYPE | WATT | =WATT | KELVIN | LUMEN | mm    | PACKING | PRICE (€) |
|---------------|-----------|------|------|------|-------|--------|-------|-------|---------|-----------|
| 5207227064265 | 147-78270 | E14  | G45  | 6.5W | 60W   | 6500K  | 806   | 45 82 | 1/10/50 | 5.50      |
| 5207227064272 | 147-78271 | E14  | G45  | 6.5W | 60W   | 4000K  | 806   | 45 82 | 1/10/50 | 5.50      |
| 5207227036590 | 147-78272 | E14  | G45  | 6.5W | 60W   | 3000K  | 806   | 45 82 | 1/10/50 | 5.50      |
| 5207227064289 | 147-78280 | E27  | G45  | 6.5W | 60W   | 6500K  | 806   | 45 82 | 1/10/50 | 5.50      |
| 5207227064296 | 147-78281 | E27  | G45  | 6.5W | 60W   | 4000K  | 806   | 45 82 | 1/10/50 | 5.50      |
| 5207227036606 | 147-78282 | E27  | G45  | 6.5W | 60W   | 3000K  | 806   | 45 82 | 1/10/50 | 5.50      |

- LED FILAMENT CROSSED BULBS
- ΛΑΜΠΤΗΡΕΣ LED FILAMENT CROSSED  
**FROST** • G45 / E14 & E27

**CROSS**  
*Filament*

PRODUCTION MATERIAL: **GLASS WITH ALUMINIUM BASE**  
ΥΛΙΚΟ ΚΑΤΑΣΚΕΥΗΣ: **ΓΥΑΛΙ ΜΕ ΒΑΣΗ ΑΛΟΥΜΙΝΙΟΥ**

WindowPaper  
**Blister**  
PACKING

PLUS  
NOT DIMMABLE  
A++ ENERGY CLASS  
90% ENERGY SAVING  
2 YEARS GUARANTEE

VOLT 220-240V 50-60Hz  
BEAM ANGLE 360°  
PF >0.50  
CRI Ra >90  
Hg 0.00%  
25000 ON-OFF  
25000h LIFETIME  
START TIME min: 0.5 sec  
-30°C ~ +45°C OPERATING TEMP.

| BARCODE       | CODE      | BASE | TYPE | WATT | =WATT | KELVIN | LUMEN | mm    | PACKING | PRICE (€) |
|---------------|-----------|------|------|------|-------|--------|-------|-------|---------|-----------|
| 5207227036484 | 147-78224 | E14  | G45  | 4.5W | 40W   | 3000K  | 480   | 45 78 | 1/10/50 | 3.40      |
| 5207227036583 | 147-78264 | E27  | G45  | 4.5W | 40W   | 3000K  | 480   | 45 78 | 1/10/50 | 3.40      |

- LED FILAMENT CROSSED BULBS
- ΛΑΜΠΤΗΡΕΣ LED FILAMENT CROSSED  
G95 / G120 - E27



CROSS  
Filament

PRODUCTION MATERIAL: **GLASS WITH ALUMINIUM BASE**  
ΥΛΙΚΟ ΚΑΤΑΣΚΕΥΗΣ: **ΓΥΑΛΙ ΜΕ ΒΑΣΗ ΑΛΟΥΜΙΝΙΟΥ**

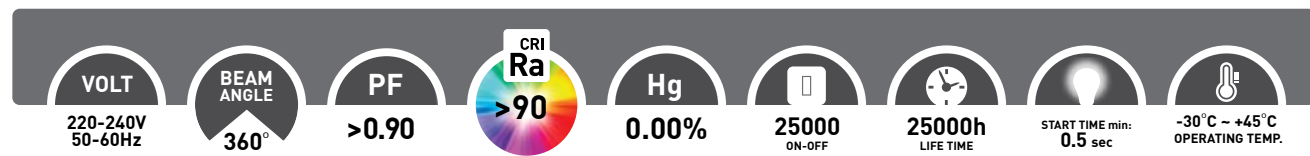

| BARCODE       | CODE      | BASE | TYPE | WATT =WATT | KELVIN | LUMEN | mm      | PACKING | PRICE (€) |
|---------------|-----------|------|------|------------|--------|-------|---------|---------|-----------|
| 5207227036637 | 147-78421 | E27  | G95  | 8W 75W     | 3000K  | 1055  | 95 140  | 1/5/20  | 5.60      |
| 5207227036644 | 147-78422 | E27  | G95  | 11W 105W   | 3000K  | 1600  | 95 140  | 1/5/20  | 7.50      |
| 5207227036675 | 147-78451 | E27  | G125 | 8W 75W     | 3000K  | 1055  | 125 180 | 1/5/20  | 7.00      |
| 5207227036682 | 147-78452 | E27  | G125 | 11W 105W   | 3000K  | 1600  | 125 180 | 1/5/20  | 8.90      |

- LED FILAMENT CROSSED BULBS
- ΛΑΜΠΤΗΡΕΣ LED FILAMENT CROSSED  
**MILKY** • G95 / G120 - E27



CROSS  
Filament

PRODUCTION MATERIAL: **GLASS WITH ALUMINIUM BASE**  
ΥΛΙΚΟ ΚΑΤΑΣΚΕΥΗΣ: **ΓΥΑΛΙ ΜΕ ΒΑΣΗ ΑΛΟΥΜΙΝΙΟΥ**

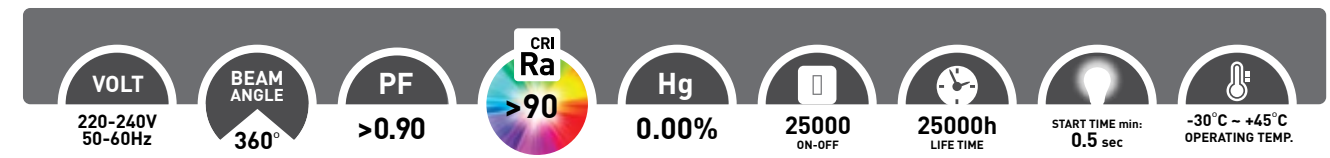

| BARCODE       | CODE      | BASE | TYPE | WATT =WATT | KELVIN | LUMEN | mm      | PACKING | PRICE (€) |
|---------------|-----------|------|------|------------|--------|-------|---------|---------|-----------|
| 5207227036613 | 147-78411 | E27  | G95  | 8W 75W     | 4000K  | 1055  | 95 140  | 1/5/20  | 6.60      |
| 5207227036620 | 147-78412 | E27  | G95  | 11W 105W   | 4000K  | 1600  | 95 140  | 1/5/20  | 8.50      |
| 5207227036651 | 147-78441 | E27  | G125 | 8W 75W     | 4000K  | 1055  | 125 180 | 1/5/20  | 8.65      |
| 5207227036668 | 147-78442 | E27  | G125 | 11W 105W   | 4000K  | 1600  | 125 180 | 1/5/20  | 10.55     |

- LED FILAMENT CROSSED BULBS
- ΛΑΜΠΤΗΡΕΣ LED FILAMENT CROSSED  
**DIMMABLE** • G95 / G125 - E27



CROSS  
Filament

PRODUCTION MATERIAL: **GLASS WITH ALUMINIUM BASE**  
ΥΛΙΚΟ ΚΑΤΑΣΚΕΥΗΣ: **ΓΥΑΛΙ ΜΕ ΒΑΣΗ ΑΛΟΥΜΙΝΙΟΥ**

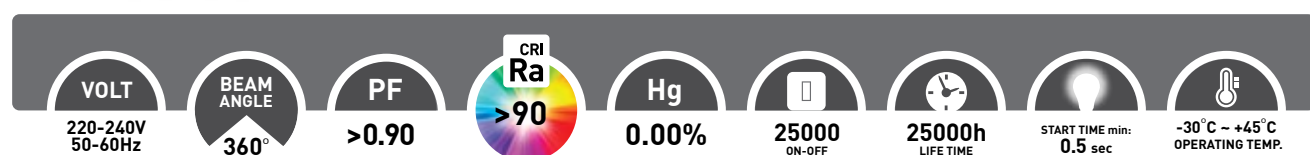

| BARCODE       | CODE      | BASE | TYPE | WATT =WATT | KELVIN | LUMEN | mm      | PACKING | PRICE (€) |
|---------------|-----------|------|------|------------|--------|-------|---------|---------|-----------|
| 5207227055836 | 147-78460 | E27  | G95  | 11W 105W   | 6500K  | 1600  | 95 140  | 1/5/20  | 10.20     |
| 5207227036699 | 147-78461 | E27  | G95  | 11W 105W   | 4000K  | 1600  | 95 140  | 1/5/20  | 10.20     |
| 5207227036712 | 147-78471 | E27  | G95  | 11W 105W   | 3000K  | 1600  | 95 140  | 1/5/20  | 10.20     |
| 5207227036705 | 147-78462 | E27  | G125 | 11W 105W   | 4000K  | 1600  | 125 180 | 1/5/20  | 12.10     |
| 5207227036729 | 147-78472 | E27  | G125 | 11W 105W   | 3000K  | 1600  | 125 180 | 1/5/20  | 12.10     |

- LED FILAMENT CROSSED BULBS
- ΛΑΜΠΤΗΡΕΣ LED FILAMENT CROSSED  
**DIMMABLE** • ST64 - E27



CROSS  
Filament

PRODUCTION MATERIAL: **GLASS WITH ALUMINIUM BASE**  
ΥΛΙΚΟ ΚΑΤΑΣΚΕΥΗΣ: **ΓΥΑΛΙ ΜΕ ΒΑΣΗ ΑΛΟΥΜΙΝΙΟΥ**

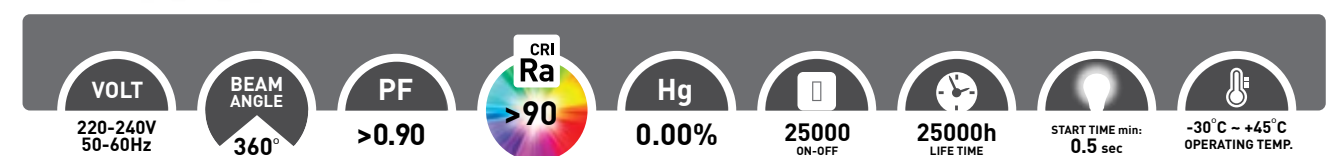

| BARCODE       | CODE      | BASE | TYPE | WATT =WATT | KELVIN | LUMEN | mm     | PACKING | PRICE (€) |
|---------------|-----------|------|------|------------|--------|-------|--------|---------|-----------|
| 5207227057038 | 147-78480 | E27  | ST64 | 11W 105W   | 6500K  | 1600  | 64 140 | 1/10/50 | 9.85      |
| 5207227057069 | 147-78481 | E27  | ST64 | 11W 105W   | 4000K  | 1600  | 64 140 | 1/10/50 | 9.85      |
| 5207227036736 | 147-78482 | E27  | ST64 | 11W 105W   | 3000K  | 1600  | 64 140 | 1/10/50 | 9.85      |

LED FILAMENT BULBS • ΛΑΜΠΤΗΡΕΣ LED FILAMENT  
A60 -E27 / **BLISTER**



Filament



PRODUCTION MATERIAL: **GLASS WITH ALUMINIUM BASE**  
ΥΛΙΚΟ ΚΑΤΑΣΚΕΥΗΣ: **ΓΥΑΛΙ ΜΕ ΒΑΣΗ ΑΛΟΥΜΙΝΙΟΥ**

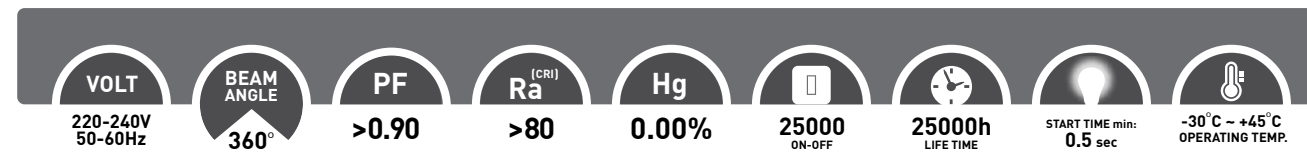

| BARCODE       | CODE      | BASE | TYPE | WATT | =WATT | KELVIN | LUMEN | mm | mm  | PACKING | PRICE (€) |
|---------------|-----------|------|------|------|-------|--------|-------|----|-----|---------|-----------|
| 5207227019449 | 800-81031 | E27  | A60  | 5W   | 40W   | 2700K  | 480   | 60 | 106 | 1/10/50 | 4.45      |
| 5207227019470 | 800-81033 | E27  | A60  | 7W   | 65W   | 2700K  | 850   | 60 | 106 | 1/10/50 | 5.60      |

LED FILAMENT BULBS • ΛΑΜΠΤΗΡΕΣ LED FILAMENT  
C37 -E14 / **BLISTER**



Filament



PRODUCTION MATERIAL: **GLASS WITH ALUMINIUM BASE**  
ΥΛΙΚΟ ΚΑΤΑΣΚΕΥΗΣ: **ΓΥΑΛΙ ΜΕ ΒΑΣΗ ΑΛΟΥΜΙΝΙΟΥ**

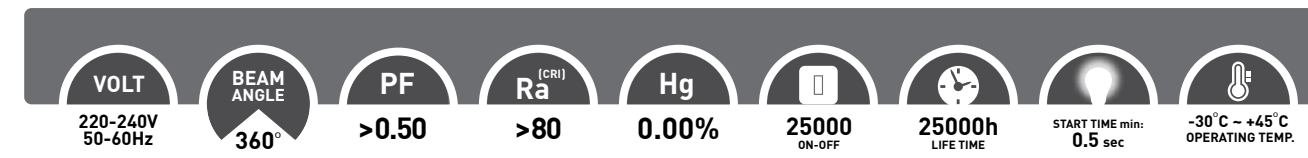

| BARCODE       | CODE      | BASE | TYPE | WATT | =WATT | KELVIN | LUMEN | mm | mm | PACKING | PRICE (€) |
|---------------|-----------|------|------|------|-------|--------|-------|----|----|---------|-----------|
| 5207227019500 | 800-81131 | E14  | C37  | 4W   | 40W   | 2700K  | 480   | 35 | 98 | 1/10/50 | 3.40      |

LED FILAMENT BULBS • ΛΑΜΠΤΗΡΕΣ LED FILAMENT  
A60 -E27 / **2 PCS BLISTER**



Filament



PRODUCTION MATERIAL: **GLASS WITH ALUMINIUM BASE**  
ΥΛΙΚΟ ΚΑΤΑΣΚΕΥΗΣ: **ΓΥΑΛΙ ΜΕ ΒΑΣΗ ΑΛΟΥΜΙΝΙΟΥ**

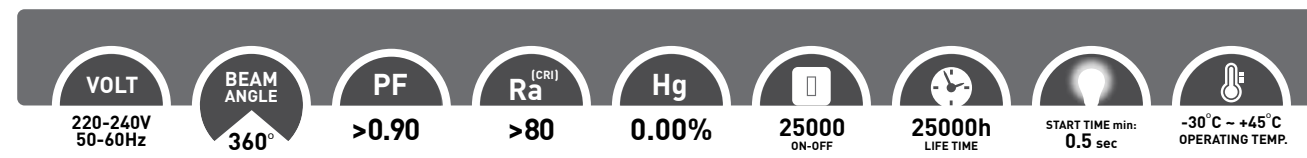

| BARCODE       | CODE      | BASE | TYPE | WATT | =WATT | KELVIN | LUMEN | mm | mm  | PACKING | PRICE (€) |
|---------------|-----------|------|------|------|-------|--------|-------|----|-----|---------|-----------|
| 5207227022555 | 800-81042 | E27  | A60  | 8W   | 75W   | 2700K  | 1055  | 60 | 106 | 1/8/32  | 10.05     |

LED FILAMENT BULBS • ΛΑΜΠΤΗΡΕΣ LED FILAMENT  
G45 -E14 / **BLISTER**



Filament



PRODUCTION MATERIAL: **GLASS WITH ALUMINIUM BASE**  
ΥΛΙΚΟ ΚΑΤΑΣΚΕΥΗΣ: **ΓΥΑΛΙ ΜΕ ΒΑΣΗ ΑΛΟΥΜΙΝΙΟΥ**

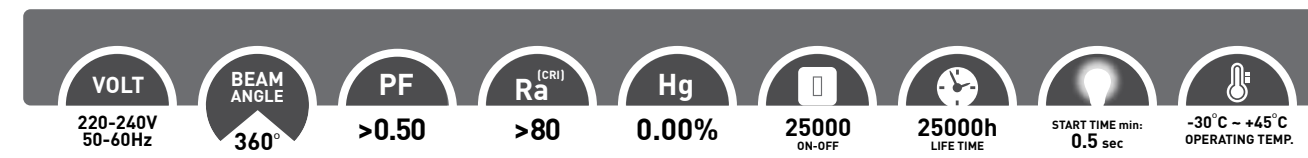

| BARCODE       | CODE      | BASE | TYPE | WATT | =WATT | KELVIN | LUMEN | mm | mm | PACKING | PRICE (€) |
|---------------|-----------|------|------|------|-------|--------|-------|----|----|---------|-----------|
| 5207227019531 | 800-81231 | E14  | G45  | 4W   | 40W   | 2700K  | 480   | 45 | 78 | 1/10/50 | 3.40      |



Types: A / C / F / G / R

**LED**

SMD Common Bulbs

Discover our Collection ▶

LED SMD BULBS • ΛΑΜΠΤΗΡΕΣ ΚΟΙΝΟΙ LED SMD  
A60 / A80 / A95 - E27



PRODUCTION MATERIAL: **PLASTIC WITH ALUMINIUM HEATSINK**  
ΥΛΙΚΟ ΚΑΤΑΣΚΕΥΗΣ: **ΠΛΑΣΤΙΚΟ ΜΕ ΨΥΚΤΡΑ ΑΛΟΥΜΙΝΙΟΥ**

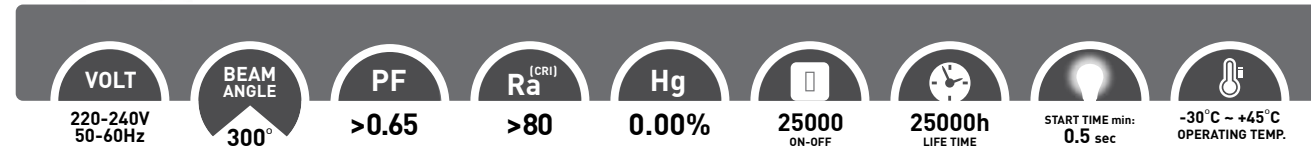

| BARCODE       | CODE      | BASE | TYPE | WATT | =WATT | KELVIN | LUMEN | ↑ mm | ∅  | PACKING | PRICE (€) |
|---------------|-----------|------|------|------|-------|--------|-------|------|----|---------|-----------|
| 5206139097002 | 147-80200 | E27  | A60  | 6W   | 40W   | 6500K  | 480   | 107  | 60 | 1/10/50 | 2.25      |
| 5206139097033 | 147-80201 | E27  | A60  | 8W   | 55W   | 6500K  | 650   | 107  | 60 | 1/10/50 | 2.30      |
| 5206139097064 | 147-80202 | E27  | A60  | 10W  | 60W   | 6500K  | 810   | 107  | 60 | 1/10/50 | 2.55      |
| 5206139097095 | 147-80203 | E27  | A60  | 12W  | 75W   | 6500K  | 1055  | 107  | 60 | 1/10/50 | 2.85      |
| 5206139050298 | 147-80204 | E27  | A60  | 15W  | 105W  | 6500K  | 1521  | 113  | 60 | 1/10/50 | 4.40      |
| 5206139050328 | 147-80207 | E27  | A80  | 20W  | 120W  | 6500K  | 1880  | 142  | 80 | 1/10/30 | 8.00      |
| 5207227014499 | 147-80209 | E27  | A95  | 24W  | 170W  | 6500K  | 2800  | 179  | 95 | 1/10/30 | 11.75     |

| BARCODE       | CODE      | BASE | TYPE | WATT | =WATT | KELVIN | LUMEN | ↑ mm | ∅  | PACKING | PRICE (€) |
|---------------|-----------|------|------|------|-------|--------|-------|------|----|---------|-----------|
| 5206139042675 | 147-80260 | E27  | A60  | 6W   | 40W   | 4000K  | 480   | 107  | 60 | 1/10/50 | 2.25      |
| 5206139050441 | 147-80261 | E27  | A60  | 8W   | 55W   | 4000K  | 650   | 107  | 60 | 1/10/50 | 2.30      |
| 5206139050489 | 147-80262 | E27  | A60  | 10W  | 60W   | 4000K  | 810   | 107  | 60 | 1/10/50 | 2.55      |
| 5206139043276 | 147-80263 | E27  | A60  | 12W  | 75W   | 4000K  | 1055  | 107  | 60 | 1/10/50 | 2.85      |
| 5206139076809 | 147-82116 | E27  | A60  | 15W  | 105W  | 4000K  | 1521  | 113  | 60 | 1/10/50 | 4.40      |
| 5206139076847 | 147-82118 | E27  | A80  | 20W  | 120W  | 4000K  | 1880  | 142  | 80 | 1/10/30 | 8.00      |
| 5207227037467 | 147-82209 | E27  | A95  | 24W  | 170W  | 4000K  | 2800  | 179  | 95 | 1/10/30 | 11.75     |

| BARCODE       | CODE      | BASE | TYPE | WATT | =WATT | KELVIN | LUMEN | ↑ mm | ∅  | PACKING | PRICE (€) |
|---------------|-----------|------|------|------|-------|--------|-------|------|----|---------|-----------|
| 5206139097125 | 147-80210 | E27  | A60  | 6W   | 40W   | 2700K  | 480   | 107  | 60 | 1/10/50 | 2.25      |
| 5206139097156 | 147-80211 | E27  | A60  | 8W   | 55W   | 2700K  | 650   | 107  | 60 | 1/10/50 | 2.30      |
| 5206139097187 | 147-80212 | E27  | A60  | 10W  | 60W   | 2700K  | 810   | 107  | 60 | 1/10/50 | 2.55      |
| 5206139097217 | 147-80213 | E27  | A60  | 12W  | 75W   | 2700K  | 1055  | 107  | 60 | 1/10/50 | 2.85      |
| 5206139050359 | 147-80214 | E27  | A60  | 15W  | 105W  | 2700K  | 1521  | 113  | 60 | 1/10/50 | 4.40      |
| 5206139050380 | 147-80217 | E27  | A80  | 20W  | 120W  | 2700K  | 1880  | 142  | 80 | 1/10/30 | 8.00      |
| 5207227014581 | 147-80219 | E27  | A95  | 24W  | 170W  | 2700K  | 2800  | 179  | 95 | 1/10/30 | 11.75     |

LED SMD BULBS • ΛΑΜΠΤΗΡΕΣ ΚΟΙΝΟΙ LED SMD  
A60 / A80 - B22



PRODUCTION MATERIAL: **PLASTIC WITH ALUMINIUM HEATSINK**  
ΥΛΙΚΟ ΚΑΤΑΣΚΕΥΗΣ: **ΠΛΑΣΤΙΚΟ ΜΕ ΨΥΚΤΡΑ ΑΛΟΥΜΙΝΙΟΥ**



| BARCODE       | CODE      | BASE | TYPE | WATT | =WATT | KELVIN | LUMEN | ↑ mm | ∅  | PACKING | PRICE (€) |
|---------------|-----------|------|------|------|-------|--------|-------|------|----|---------|-----------|
| 5206139035707 | 147-80250 | B22  | A60  | 6W   | 40W   | 6500K  | 480   | 107  | 60 | 1/10/50 | 2.25      |
| 5206139035738 | 147-80251 | B22  | A60  | 8W   | 55W   | 6500K  | 650   | 107  | 60 | 1/10/50 | 2.30      |
| 5206139035769 | 147-80252 | B22  | A60  | 10W  | 60W   | 6500K  | 810   | 107  | 60 | 1/10/50 | 2.55      |
| 5206139076878 | 147-82135 | B22  | A60  | 12W  | 75W   | 6500K  | 1055  | 110  | 60 | 1/10/50 | 2.85      |
| 5207227003981 | 147-82136 | B22  | A60  | 15W  | 105W  | 6500K  | 1521  | 113  | 60 | 1/10/50 | 4.40      |
| 5207227004018 | 147-82138 | B22  | A80  | 20W  | 120W  | 6500K  | 1880  | 142  | 80 | 1/10/30 | 8.00      |

| BARCODE       | CODE      | BASE | TYPE | WATT | =WATT | KELVIN | LUMEN | ↑ mm | ∅  | PACKING | PRICE (€) |
|---------------|-----------|------|------|------|-------|--------|-------|------|----|---------|-----------|
| 5207227037498 | 147-82140 | B22  | A60  | 6W   | 40W   | 4000K  | 480   | 107  | 60 | 1/10/50 | 2.25      |
| 5206139014054 | 147-80258 | B22  | A60  | 8W   | 55W   | 4000K  | 650   | 107  | 60 | 1/10/50 | 2.30      |
| 5206139018922 | 147-80259 | B22  | A60  | 10W  | 60W   | 4000K  | 810   | 107  | 60 | 1/10/50 | 2.55      |
| 5206139076915 | 147-82145 | B22  | A60  | 12W  | 75W   | 4000K  | 1055  | 110  | 60 | 1/10/50 | 2.85      |
| 5206139076953 | 147-82146 | B22  | A60  | 15W  | 105W  | 4000K  | 1521  | 113  | 60 | 1/10/50 | 4.40      |
| 5207227037528 | 147-82148 | B22  | A80  | 20W  | 120W  | 4000K  | 1880  | 142  | 80 | 1/10/30 | 8.00      |

| BARCODE       | CODE      | BASE | TYPE | WATT | =WATT | KELVIN | LUMEN | ↑ mm | ∅  | PACKING | PRICE (€) |
|---------------|-----------|------|------|------|-------|--------|-------|------|----|---------|-----------|
| 5206139035790 | 147-80255 | B22  | A60  | 6W   | 40W   | 2700K  | 480   | 107  | 60 | 1/10/50 | 2.25      |
| 5206139035820 | 147-80256 | B22  | A60  | 8W   | 55W   | 2700K  | 650   | 107  | 60 | 1/10/50 | 2.30      |
| 5206139035851 | 147-80257 | B22  | A60  | 10W  | 60W   | 2700K  | 810   | 107  | 60 | 1/10/50 | 2.55      |
| 5206139076984 | 147-82155 | B22  | A60  | 12W  | 75W   | 2700K  | 1055  | 110  | 60 | 1/10/50 | 2.85      |
| 5206139070791 | 147-82156 | B22  | A60  | 15W  | 105W  | 2700K  | 1521  | 113  | 60 | 1/10/50 | 4.40      |
| 5207227037559 | 147-82158 | B22  | A80  | 20W  | 120W  | 2700K  | 1880  | 142  | 80 | 1/10/30 | 8.00      |

LED SMD BULBS • ΛΑΜΠΤΗΡΕΣ ΚΟΙΝΟΙ LED SMD  
A60 - E27 / **BLISTER**



PRODUCTION MATERIAL: **PLASTIC WITH ALUMINIUM HEATSINK**  
ΥΛΙΚΟ ΚΑΤΑΣΚΕΥΗΣ: **ΠΛΑΣΤΙΚΟ ΜΕ ΨΥΚΤΡΑ ΑΛΟΥΜΙΝΙΟΥ**

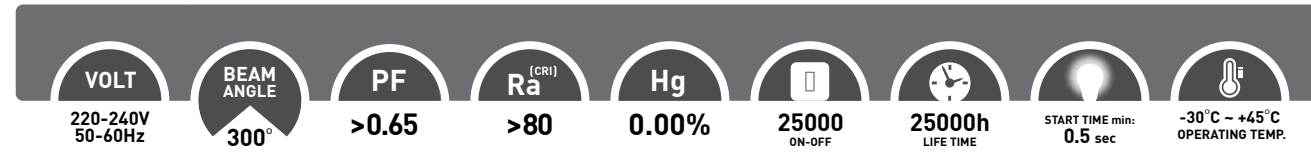

| BARCODE       | CODE      | BASE | TYPE | WATT =WATT | KELVIN | LUMEN | mm     | PACKING | PRICE (€) |
|---------------|-----------|------|------|------------|--------|-------|--------|---------|-----------|
| 5206139991027 | 147-84402 | E27  | A60  | 8W 55W     | 6500K  | 650   | 110 60 | 1/10/50 | 2.75      |
| 5206139015280 | 147-84404 | E27  | A60  | 11W 70W    | 6500K  | 920   | 110 60 | 1/10/50 | 3.25      |
| 5206139040480 | 147-84405 | E27  | A60  | 13W 80W    | 6500K  | 1170  | 110 60 | 1/10/50 | 3.90      |
| 5207227058660 | 147-84406 | E27  | A60  | 15W 105W   | 6500K  | 1521  | 116 60 | 1/10/50 | 4.65      |
| 5206139991126 | 147-84412 | E27  | A60  | 8W 55W     | 2700K  | 650   | 110 60 | 1/10/50 | 2.75      |
| 5206139015297 | 147-84414 | E27  | A60  | 11W 70W    | 2700K  | 920   | 110 60 | 1/10/50 | 3.25      |
| 5206139040664 | 147-84415 | E27  | A60  | 13W 80W    | 2700K  | 1170  | 110 60 | 1/10/50 | 3.90      |
| 5207227058691 | 147-84416 | E27  | A60  | 15W 105W   | 2700K  | 1521  | 116 60 | 1/10/50 | 4.65      |

LED SMD BULBS • ΛΑΜΠΤΗΡΕΣ ΚΟΙΝΟΙ LED SMD  
**DIMMABLE** / A60 - E27 / B22



PRODUCTION MATERIAL: **PLASTIC WITH ALUMINIUM HEATSINK**  
ΥΛΙΚΟ ΚΑΤΑΣΚΕΥΗΣ: **ΠΛΑΣΤΙΚΟ ΜΕ ΨΥΚΤΡΑ ΑΛΟΥΜΙΝΙΟΥ**

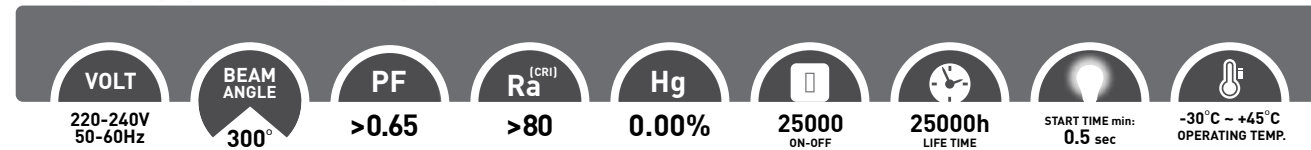

| BARCODE       | CODE      | BASE | TYPE | WATT =WATT | KELVIN | LUMEN | mm     | PACKING | PRICE (€) |
|---------------|-----------|------|------|------------|--------|-------|--------|---------|-----------|
| 5206139071460 | 147-82174 | E27  | A60  | 9W 60W     | 2700K  | 810   | 107 60 | 1/10/50 | 4.75      |
| 5207227037580 | 147-82166 | E27  | A60  | 12W 75W    | 6500K  | 1055  | 107 60 | 1/10/50 | 5.10      |
| 5207227036828 | 147-82186 | E27  | A60  | 12W 75W    | 2700K  | 1055  | 107 60 | 1/10/50 | 5.10      |
| 5207227072475 | 147-77093 | B22  | A60  | 12W 75W    | 6500K  | 1055  | 107 60 | 1/10/50 | 5.10      |
| 5207227072482 | 147-77095 | B22  | A60  | 12W 75W    | 3000K  | 1055  | 107 60 | 1/10/50 | 5.10      |

LED SMD BULBS • ΛΑΜΠΤΗΡΕΣ ΚΟΙΝΟΙ LED SMD  
A55 / A60 / A65 / A67 - E27



PRODUCTION MATERIAL: **PLASTIC WITH ALUMINIUM HEATSINK**  
ΥΛΙΚΟ ΚΑΤΑΣΚΕΥΗΣ: **ΠΛΑΣΤΙΚΟ ΜΕ ΨΥΚΤΡΑ ΑΛΟΥΜΙΝΙΟΥ**

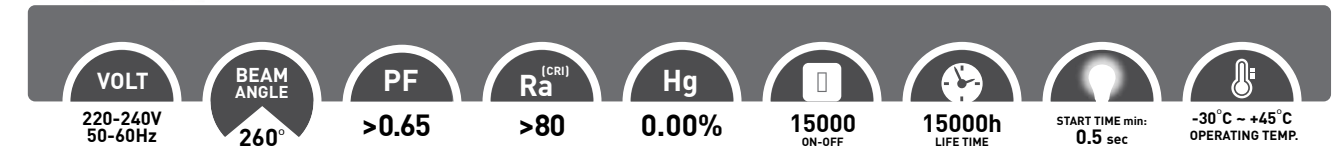

| BARCODE       | CODE      | BASE | TYPE | WATT =WATT | KELVIN | LUMEN | mm     | PACKING  | PRICE (€) |
|---------------|-----------|------|------|------------|--------|-------|--------|----------|-----------|
| 5206139084422 | 180-80201 | E27  | A55  | 6W 40W     | 6500K  | 480   | 98 55  | 1/10/100 | 1.90      |
| 5206139084439 | 180-80203 | E27  | A60  | 9W 60W     | 6500K  | 806   | 108 60 | 1/10/100 | 2.05      |
| 5206139084446 | 180-80205 | E27  | A60  | 12W 75W    | 6500K  | 1060  | 112 60 | 1/10/100 | 2.35      |
| 5206139084453 | 180-80207 | E27  | A65  | 15W 95W    | 6500K  | 1450  | 118 65 | 1/10/100 | 3.45      |
| 5207227072499 | 180-77006 | E27  | A65  | 20W 115W   | 6500K  | 1800  | 127 65 | 1/10/100 | 6.40      |
| 5207227072505 | 180-77007 | E27  | A67  | 25W 150W   | 6500K  | 2500  | 139 67 | 1/10/100 | 9.40      |

| BARCODE       | CODE      | BASE | TYPE | WATT =WATT | KELVIN | LUMEN | mm     | PACKING  | PRICE (€) |
|---------------|-----------|------|------|------------|--------|-------|--------|----------|-----------|
| 5206139084507 | 180-80211 | E27  | A55  | 6W 40W     | 4000K  | 480   | 98 55  | 1/10/100 | 1.90      |
| 5206139084514 | 180-80213 | E27  | A60  | 9W 60W     | 4000K  | 806   | 108 60 | 1/10/100 | 2.05      |
| 5206139084538 | 180-80215 | E27  | A60  | 12W 75W    | 4000K  | 1060  | 112 60 | 1/10/100 | 2.35      |
| 5206139084545 | 180-80217 | E27  | A65  | 15W 95W    | 4000K  | 1450  | 118 65 | 1/10/100 | 3.45      |
| 5207227072512 | 180-77016 | E27  | A65  | 20W 115W   | 4000K  | 1800  | 127 65 | 1/10/100 | 6.40      |
| 5207227072529 | 180-77017 | E27  | A67  | 25W 150W   | 4000K  | 2500  | 139 67 | 1/10/100 | 9.40      |

| BARCODE       | CODE      | BASE | TYPE | WATT =WATT | KELVIN | LUMEN | mm     | PACKING  | PRICE (€) |
|---------------|-----------|------|------|------------|--------|-------|--------|----------|-----------|
| 5207227064319 | 180-80231 | E27  | A55  | 6W 40W     | 3000K  | 480   | 98 55  | 1/10/100 | 1.90      |
| 5207227057960 | 180-80233 | E27  | A60  | 9W 60W     | 3000K  | 806   | 108 60 | 1/10/100 | 2.05      |
| 5207227058073 | 180-80235 | E27  | A60  | 12W 75W    | 3000K  | 1060  | 112 60 | 1/10/100 | 2.35      |
| 5207227058103 | 180-80237 | E27  | A65  | 15W 95W    | 3000K  | 1450  | 118 65 | 1/10/100 | 3.45      |
| 5207227072536 | 180-77026 | E27  | A65  | 20W 115W   | 3000K  | 1800  | 127 65 | 1/10/100 | 6.40      |
| 5207227072543 | 180-77027 | E27  | A67  | 25W 150W   | 3000K  | 2500  | 139 67 | 1/10/100 | 9.40      |

| BARCODE       | CODE      | BASE | TYPE | WATT =WATT | KELVIN | LUMEN | mm     | PACKING  | PRICE (€) |
|---------------|-----------|------|------|------------|--------|-------|--------|----------|-----------|
| 5206139084552 | 180-80221 | E27  | A55  | 6W 40W     | 2700K  | 480   | 98 55  | 1/10/50  | 1.90      |
| 5206139084569 | 180-80223 | E27  | A60  | 9W 60W     | 2700K  | 806   | 108 60 | 1/10/100 | 2.05      |
| 5206139084576 | 180-80225 | E27  | A60  | 12W 75W    | 2700K  | 1060  | 112 60 | 1/10/100 | 2.35      |
| 5206139084590 | 180-80227 | E27  | A65  | 15W 95W    | 2700K  | 1450  | 118 65 | 1/10/100 | 3.45      |
| 5207227072550 | 180-77036 | E27  | A65  | 20W 115W   | 2700K  | 1800  | 127 65 | 1/10/100 | 6.40      |
| 5207227072567 | 180-77037 | E27  | A67  | 25W 150W   | 2700K  | 2500  | 139 67 | 1/10/100 | 9.40      |

LED SMD BULBS • ΛΑΜΠΤΗΡΕΣ ΚΟΙΝΟΙ LED SMD  
A60 / A65 - E27 / MULTI-PACK **BLISTER & DISPLAY PALLET**



PRODUCTION MATERIAL: **PLASTIC WITH ALUMINIUM HEATSINK**  
ΥΛΙΚΟ ΚΑΤΑΣΚΕΥΗΣ: **ΠΛΑΣΤΙΚΟ ΜΕ ΨΥΚΤΡΑ ΑΛΟΥΜΙΝΙΟΥ**

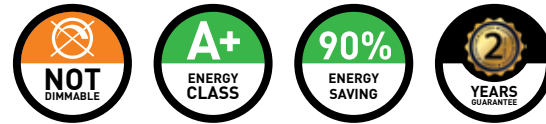

**VOLT** 220-240V 50-60Hz  
**BEAM ANGLE** 260°  
**PF** >0.65  
**Ra (CRI)** >80  
**Hg** 0.00%  
**ON-OFF** 15000  
**LIFE TIME** 15000h  
**START TIME min:** 0.5 sec  
**OPERATING TEMP.** -30°C ~ +45°C

| BARCODE       | CODE      | BASE | TYPE | WATT | =WATT | KELVIN | LUMEN | mm     | PACKING | PRICE (€) |
|---------------|-----------|------|------|------|-------|--------|-------|--------|---------|-----------|
| 5207227037047 | 180-80250 | E27  | A60  | 9W   | 60W   | 6500K  | 810   | 108 60 | 1/8/32  | 4.00      |
| 5207227037054 | 180-80252 | E27  | A60  | 9W   | 60W   | 2700K  | 810   | 108 60 | 1/8/32  | 4.00      |



|               |           |     |     |     |     |       |      |        |         |      |
|---------------|-----------|-----|-----|-----|-----|-------|------|--------|---------|------|
| 5207227055843 | 180-84403 | E27 | A60 | 10W | 65W | 6500K | 850  | 108 60 | 1/10/50 | 4.00 |
| 5207227055867 | 180-84413 | E27 | A60 | 10W | 65W | 4000K | 850  | 108 60 | 1/10/50 | 4.00 |
| 5207227055850 | 180-84405 | E27 | A65 | 15W | 94W | 6500K | 1350 | 118 65 | 1/10/50 | 6.00 |
| 5207227055874 | 180-84415 | E27 | A65 | 15W | 94W | 4000K | 1350 | 118 65 | 1/10/50 | 6.00 |



| BARCODE       | CODE      | BASE | TYPE | WATT | =WATT | KELVIN | LUMEN | mm     | PACKING | PRICE (€) |
|---------------|-----------|------|------|------|-------|--------|-------|--------|---------|-----------|
| 5207227033391 | 180-80253 | E27  | A60  | 9W   | 60W   | 6500K  | 810   | 108 60 | 1/5/30  | 6.00      |
| 5207227033421 | 180-80255 | E27  | A60  | 9W   | 60W   | 3000K  | 810   | 108 60 | 1/5/30  | 6.00      |



• Οι τιμές για τους παρακάτω κωδικούς διαμορφώνονται κατόπιν συμφωνίας  
• Please contact us for prices of the following products

| BARCODE       | CODE      | BASE | TYPE | WATT | =WATT | KELVIN | LUMEN | mm     | PACKING |
|---------------|-----------|------|------|------|-------|--------|-------|--------|---------|
| 5207227059766 | 180-84001 | E27  | A60  | 6W   | 40W   | 6500K  | 480   | 107 60 | 1/36/72 |
| 5207227059797 | 180-84003 | E27  | A60  | 10W  | 65W   | 6500K  | 850   | 108 60 | 1/36/72 |
| 5207227059827 | 180-84005 | E27  | A60  | 12W  | 75W   | 6500K  | 1060  | 112 60 | 1/36/72 |



• Οι τιμές για τους παρακάτω κωδικούς διαμορφώνονται κατόπιν συμφωνίας  
• Please contact us for prices of the following products

| BARCODE       | CODE      | BASE | TYPE | WATT | =WATT | KELVIN | LUMEN | mm     | PACKING |
|---------------|-----------|------|------|------|-------|--------|-------|--------|---------|
| 5207227059858 | 180-84053 | E27  | A60  | 10W  | 65W   | 6500K  | 850   | 108 60 | 1/12/24 |

LED TUBULAR SMD BULBS • ΛΑΜΠΤΗΡΕΣ ΣΩΛΗΝΩΤΟΙ LED SMD  
T40 - E27



PRODUCTION MATERIAL: **PLASTIC WITH ALUMINIUM HEATSINK**  
ΥΛΙΚΟ ΚΑΤΑΣΚΕΥΗΣ: **ΠΛΑΣΤΙΚΟ ΜΕ ΨΥΚΤΡΑ ΑΛΟΥΜΙΝΙΟΥ**



**VOLT** 220-240V 50-60Hz  
**BEAM ANGLE** 260°  
**PF** >0.65  
**Ra (CRI)** >80  
**Hg** 0.00%  
**ON-OFF** 25000  
**LIFE TIME** 25000h  
**START TIME min:** 0.5 sec  
**OPERATING TEMP.** -30°C ~ +45°C

| BARCODE       | CODE      | BASE | TYPE | WATT | =WATT | KELVIN | LUMEN | mm       | PACKING | PRICE (€) |
|---------------|-----------|------|------|------|-------|--------|-------|----------|---------|-----------|
| 5207227036989 | 147-84850 | E27  | T40  | 9W   | 65W   | 6500K  | 806   | 115 40   | 1/10/50 | 5.20      |
| 5207227036996 | 147-84851 | E27  | T40  | 9W   | 65W   | 4000K  | 806   | 115 40   | 1/10/50 | 5.20      |
| 5207227037009 | 147-84852 | E27  | T40  | 9W   | 65W   | 3000K  | 806   | 115 40   | 1/10/50 | 5.20      |
| 5207227037016 | 147-84860 | E27  | T40  | 13W  | 80W   | 6500K  | 1170  | 120 46.5 | 1/10/50 | 5.85      |
| 5207227037023 | 147-84861 | E27  | T40  | 13W  | 80W   | 4000K  | 1170  | 120 46.5 | 1/10/50 | 5.85      |
| 5207227037030 | 147-84862 | E27  | T40  | 13W  | 80W   | 3000K  | 1170  | 120 46.5 | 1/10/50 | 5.85      |

LED SMD BULBS • ΛΑΜΠΤΗΡΕΣ ΚΟΙΝΟΙ LED SMD  
A60 - E27  
**12V • 24V • 42V - AC/DC**



PRODUCTION MATERIAL: **PLASTIC WITH ALUMINIUM HEATSINK**  
ΥΛΙΚΟ ΚΑΤΑΣΚΕΥΗΣ: **ΠΛΑΣΤΙΚΟ ΜΕ ΨΥΚΤΡΑ ΑΛΟΥΜΙΝΙΟΥ**



**VOLT** 12-24V AC/DC 50-60Hz  
**VOLT** 42V AC 50-60Hz  
**BEAM ANGLE** 230°  
**PF** >0.70  
**Ra (CRI)** >80  
**Hg** 0.00%  
**ON-OFF** 25000  
**LIFE TIME** 25000h  
**START TIME min:** 0.5 sec  
**OPERATING TEMP.** -30°C ~ +45°C

| BARCODE       | CODE      | BASE | TYPE | WATT | =WATT | KELVIN | LUMEN | mm     | PACKING | PRICE (€) |
|---------------|-----------|------|------|------|-------|--------|-------|--------|---------|-----------|
| 5207227011610 | 147-84825 | E27  | A60  | 10W  | 60W   | 6500K  | 806   | 116 60 | 1/10/50 | 7.85      |
| 5207227011580 | 147-84826 | E27  | A60  | 10W  | 60W   | 3000K  | 806   | 116 60 | 1/10/50 | 7.85      |

LED SMD BULBS • ΛΑΜΠΤΗΡΕΣ ΚΟΙΝΟΙ LED SMD  
MINION • C37 - E14

PRODUCTION MATERIAL: **PLASTIC WITH ALUMINIUM HEATSINK**  
ΥΛΙΚΟ ΚΑΤΑΣΚΕΥΗΣ: **ΠΛΑΣΤΙΚΟ ΜΕ ΨΥΚΤΡΑ ΑΛΟΥΜΙΝΙΟΥ**



|                  |            |       |                     |       |              |                  |                         |                               |
|------------------|------------|-------|---------------------|-------|--------------|------------------|-------------------------|-------------------------------|
| VOLT             | BEAM ANGLE | PF    | Ra <sup>(CRI)</sup> | Hg    | 25000 ON-OFF | 25000h LIFE TIME | START TIME min: 0.5 sec | -30°C ~ +45°C OPERATING TEMP. |
| 220-240V 50-60Hz | 200°       | >0.55 | >80                 | 0.00% |              |                  |                         |                               |

| BARCODE       | CODE      | BASE | TYPE | WATT | =WATT | KELVIN | LUMEN | mm    | PACKING | PRICE (€) |
|---------------|-----------|------|------|------|-------|--------|-------|-------|---------|-----------|
| 5206139097248 | 147-80222 | E14  | C35  | 5W   | 45W   | 6500K  | 400   | 97 35 | 1/10/50 | 2.05      |
| 5207227001475 | 147-82212 | E14  | C35  | 5W   | 45W   | 4000K  | 400   | 97 35 | 1/10/50 | 2.05      |
| 5206139097279 | 147-80223 | E14  | C35  | 5W   | 45W   | 2700K  | 400   | 97 35 | 1/10/50 | 2.05      |
| 5206139018939 | 147-80224 | E14  | C35  | 7W   | 60W   | 6500K  | 630   | 97 35 | 1/10/50 | 2.35      |
| 5206139018953 | 147-80225 | E14  | C35  | 7W   | 60W   | 4000K  | 630   | 97 35 | 1/10/50 | 2.35      |
| 5206139018960 | 147-80226 | E14  | C35  | 7W   | 60W   | 2700K  | 630   | 97 35 | 1/10/50 | 2.35      |

PRODUCTION MATERIAL: **PLASTIC WITH CERAMIC BASE**  
ΥΛΙΚΟ ΚΑΤΑΣΚΕΥΗΣ: **ΠΛΑΣΤΙΚΟ ΜΕ ΚΕΡΑΜΙΚΗ ΒΑΣΗ**

|               |           |     |     |     |     |       |      |        |         |      |
|---------------|-----------|-----|-----|-----|-----|-------|------|--------|---------|------|
| 5207227072574 | 147-77221 | E14 | C37 | 10W | 75W | 6500K | 1000 | 109 37 | 1/10/50 | 5.80 |
| 5207227072581 | 147-77222 | E14 | C37 | 10W | 75W | 4000K | 1000 | 109 37 | 1/10/50 | 5.80 |
| 5207227072598 | 147-77224 | E14 | C37 | 10W | 75W | 2700K | 1000 | 109 37 | 1/10/50 | 5.80 |

LED SMD BULBS • ΛΑΜΠΤΗΡΕΣ ΚΟΙΝΟΙ LED SMD  
MINION • **BLISTER** • C37 - E14

PRODUCTION MATERIAL: **PLASTIC WITH ALUMINIUM HEATSINK**  
ΥΛΙΚΟ ΚΑΤΑΣΚΕΥΗΣ: **ΠΛΑΣΤΙΚΟ ΜΕ ΨΥΚΤΡΑ ΑΛΟΥΜΙΝΙΟΥ**



|                  |            |       |                     |       |              |                  |                         |                               |
|------------------|------------|-------|---------------------|-------|--------------|------------------|-------------------------|-------------------------------|
| VOLT             | BEAM ANGLE | PF    | Ra <sup>(CRI)</sup> | Hg    | 25000 ON-OFF | 25000h LIFE TIME | START TIME min: 0.5 sec | -30°C ~ +45°C OPERATING TEMP. |
| 220-240V 50-60Hz | 200°       | >0.55 | >80                 | 0.00% |              |                  |                         |                               |

| BARCODE       | CODE      | BASE | TYPE | WATT | =WATT | KELVIN | LUMEN | mm     | PACKING | PRICE (€) |
|---------------|-----------|------|------|------|-------|--------|-------|--------|---------|-----------|
| 5206139008527 | 147-84422 | E14  | C37  | 4W   | 40W   | 6500K  | 380   | 100 37 | 1/10/50 | 2.15      |
| 5206139008558 | 147-84423 | E14  | C37  | 4W   | 40W   | 2700K  | 380   | 100 37 | 1/10/50 | 2.15      |
| 5206139021984 | 147-84424 | E14  | C37  | 6W   | 50W   | 6500K  | 470   | 100 37 | 1/10/50 | 2.45      |
| 5206139022035 | 147-84425 | E14  | C37  | 6W   | 50W   | 2700K  | 470   | 100 37 | 1/10/50 | 2.45      |

LED SMD BULBS • ΛΑΜΠΤΗΡΕΣ ΚΟΙΝΟΙ LED SMD  
MINI CANDLE TAIL • F37 - E14

PRODUCTION MATERIAL: **PLASTIC WITH ALUMINIUM HEATSINK**  
ΥΛΙΚΟ ΚΑΤΑΣΚΕΥΗΣ: **ΠΛΑΣΤΙΚΟ ΜΕ ΨΥΚΤΡΑ ΑΛΟΥΜΙΝΙΟΥ**

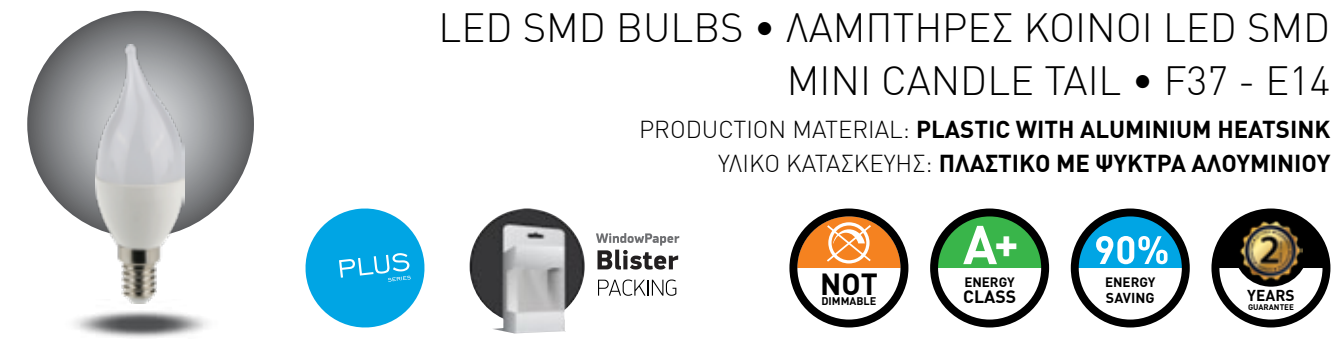

|                  |            |       |                     |       |              |                  |                         |                               |
|------------------|------------|-------|---------------------|-------|--------------|------------------|-------------------------|-------------------------------|
| VOLT             | BEAM ANGLE | PF    | Ra <sup>(CRI)</sup> | Hg    | 25000 ON-OFF | 25000h LIFE TIME | START TIME min: 0.5 sec | -30°C ~ +45°C OPERATING TEMP. |
| 220-240V 50-60Hz | 200°       | >0.55 | >80                 | 0.00% |              |                  |                         |                               |

| BARCODE       | CODE      | BASE | TYPE | WATT | =WATT | KELVIN | LUMEN | mm     | PACKING | PRICE (€) |
|---------------|-----------|------|------|------|-------|--------|-------|--------|---------|-----------|
| 5206139018977 | 147-80228 | E14  | F37  | 7W   | 60W   | 4000K  | 630   | 113 36 | 1/10/50 | 2.55      |
| 5206139018984 | 147-80229 | E14  | F37  | 7W   | 60W   | 2700K  | 630   | 113 36 | 1/10/50 | 2.55      |

LED SMD BULBS • ΛΑΜΠΤΗΡΕΣ ΚΟΙΝΟΙ LED SMD  
MINION • **DIMMABLE** • C37 - E14

PRODUCTION MATERIAL: **PLASTIC WITH ALUMINIUM HEATSINK**  
ΥΛΙΚΟ ΚΑΤΑΣΚΕΥΗΣ: **ΠΛΑΣΤΙΚΟ ΜΕ ΨΥΚΤΡΑ ΑΛΟΥΜΙΝΙΟΥ**

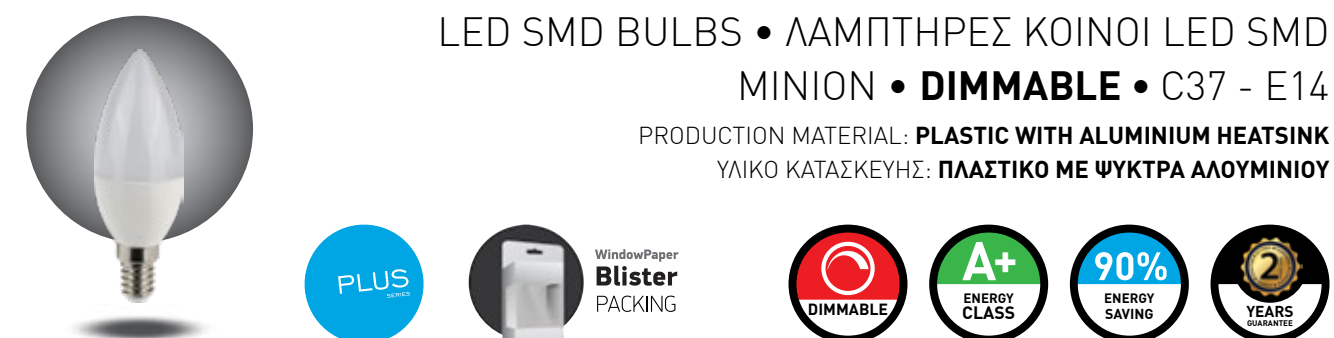

|                  |            |       |                     |       |              |                  |                         |                               |
|------------------|------------|-------|---------------------|-------|--------------|------------------|-------------------------|-------------------------------|
| VOLT             | BEAM ANGLE | PF    | Ra <sup>(CRI)</sup> | Hg    | 25000 ON-OFF | 25000h LIFE TIME | START TIME min: 0.5 sec | -30°C ~ +45°C OPERATING TEMP. |
| 220-240V 50-60Hz | 200°       | >0.55 | >80                 | 0.00% |              |                  |                         |                               |

| BARCODE       | CODE      | BASE | TYPE | WATT | =WATT | KELVIN | LUMEN | mm     | PACKING | PRICE (€) |
|---------------|-----------|------|------|------|-------|--------|-------|--------|---------|-----------|
| 5206139039866 | 147-84462 | E14  | C37  | 7W   | 60W   | 6500K  | 630   | 100 37 | 1/10/50 | 4.70      |
| 5206139039903 | 147-84464 | E14  | C37  | 7W   | 60W   | 2700K  | 630   | 100 37 | 1/10/50 | 4.70      |

LED SMD BULBS • ΛΑΜΠΤΗΡΕΣ ΚΟΙΝΟΙ LED SMD  
MINION • **MULTI-PACK BLISTER** • C37 - E14

PRODUCTION MATERIAL: **PLASTIC WITH ALUMINIUM HEATSINK**  
ΥΛΙΚΟ ΚΑΤΑΣΚΕΥΗΣ: **ΠΛΑΣΤΙΚΟ ΜΕ ΨΥΚΤΡΑ ΑΛΟΥΜΙΝΙΟΥ**



|                  |            |       |                     |       |              |                  |                         |                               |
|------------------|------------|-------|---------------------|-------|--------------|------------------|-------------------------|-------------------------------|
| VOLT             | BEAM ANGLE | PF    | Ra <sup>(CRI)</sup> | Hg    | 25000 ON-OFF | 25000h LIFE TIME | START TIME min: 0.5 sec | -30°C ~ +45°C OPERATING TEMP. |
| 220-240V 50-60Hz | 200°       | >0.55 | >80                 | 0.00% |              |                  |                         |                               |

| BARCODE       | CODE      | BASE | TYPE | WATT | =WATT | KELVIN | LUMEN | mm     | PACKING | PRICE (€) |
|---------------|-----------|------|------|------|-------|--------|-------|--------|---------|-----------|
| 5207227022616 | 800-80260 | E14  | C37  | 7W   | 60W   | 6500K  | 630   | 100 37 | 1/8/32  | 7.50      |
| 5207227022647 | 800-80262 | E14  | C37  | 7W   | 60W   | 2700K  | 630   | 100 37 | 1/8/32  | 7.50      |

LED SMD BULBS • ΛΑΜΠΤΗΡΕΣ ΚΟΙΝΟΙ LED SMD  
MINION • C37 - E14

PRODUCTION MATERIAL: **PLASTIC WITH ALUMINIUM HEATSINK**  
ΥΛΙΚΟ ΚΑΤΑΣΚΕΥΗΣ: **ΠΛΑΣΤΙΚΟ ΜΕ ΨΥΚΤΡΑ ΑΛΟΥΜΙΝΙΟΥ**



VOLT 220-240V 50-60Hz | BEAM ANGLE 260° | PF >0.55 | Ra >80 | Hg 0.00% | 15000 ON-OFF | 15000h LIFE TIME | START TIME min: 0.5 sec | -30°C ~ +45°C OPERATING TEMP.

| BARCODE       | CODE      | BASE | TYPE | WATT | =WATT | KELVIN | LUMEN | mm    | PACKING  | PRICE (€) |
|---------------|-----------|------|------|------|-------|--------|-------|-------|----------|-----------|
| 5206139084613 | 180-80301 | E14  | C37  | 5W   | 45W   | 6500K  | 380   | 99 37 | 1/10/100 | 1.65      |
| 5207227037078 | 180-80331 | E14  | C37  | 5W   | 45W   | 3000K  | 380   | 99 37 | 1/10/100 | 1.65      |
| 5206139084637 | 180-80321 | E14  | C37  | 5W   | 45W   | 2700K  | 380   | 99 37 | 1/10/100 | 1.65      |
| 5207227016233 | 180-80304 | E14  | C37  | 8W   | 60W   | 6500K  | 690   | 99 37 | 1/20/60  | 2.00      |
| 5207227037061 | 180-80314 | E14  | C37  | 8W   | 60W   | 4000K  | 690   | 99 37 | 1/20/60  | 2.00      |
| 5207227037085 | 180-80334 | E14  | C37  | 8W   | 60W   | 3000K  | 690   | 99 37 | 1/20/60  | 2.00      |
| 5207227016295 | 180-80324 | E14  | C37  | 8W   | 60W   | 2700K  | 690   | 99 37 | 1/20/60  | 2.00      |

LED SMD BULBS • ΛΑΜΠΤΗΡΕΣ ΚΟΙΝΟΙ LED SMD  
MINION • C37 - E14  
MULTI-PACK BLISTER

PRODUCTION MATERIAL: **PLASTIC WITH ALUMINIUM HEATSINK**  
ΥΛΙΚΟ ΚΑΤΑΣΚΕΥΗΣ: **ΠΛΑΣΤΙΚΟ ΜΕ ΨΥΚΤΡΑ ΑΛΟΥΜΙΝΙΟΥ**

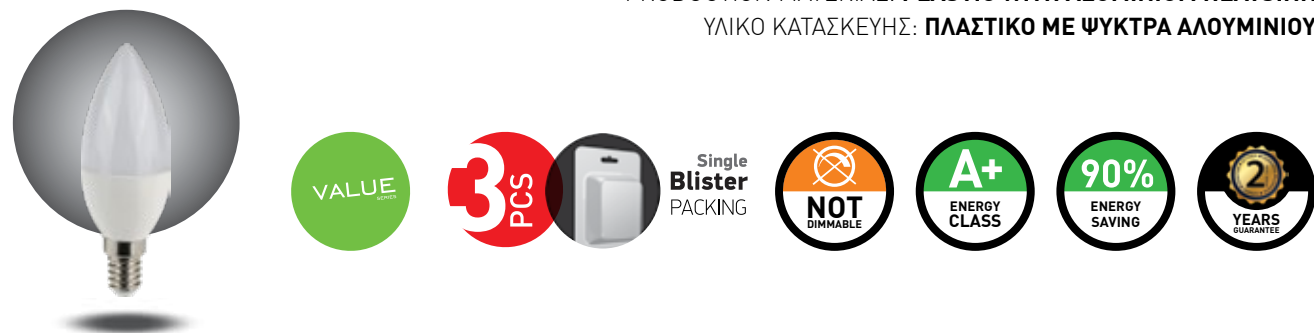

VOLT 220-240V 50-60Hz | BEAM ANGLE 200° | PF >0.65 | Ra >80 | Hg 0.00% | 15000 ON-OFF | 15000h LIFE TIME | START TIME min: 0.5 sec | -30°C ~ +45°C OPERATING TEMP.

| BARCODE       | CODE      | BASE | TYPE | WATT | =WATT | KELVIN | LUMEN | mm    | PACKING | PRICE (€) |
|---------------|-----------|------|------|------|-------|--------|-------|-------|---------|-----------|
| 5207227033452 | 180-80353 | E14  | C37  | 5W   | 45W   | 6500K  | 400   | 99 37 | 1/5/30  | 4.90      |
| 5207227033483 | 180-80355 | E14  | C37  | 5W   | 45W   | 3000K  | 400   | 99 37 | 1/5/30  | 4.90      |

• LED SMD MINI GLOBE BULBS  
• ΛΑΜΠΤΗΡΕΣ ΚΟΙΝΟΙ ΣΦΑΙΡΙΚΟΙ LED SMD  
G45 - E27 / E14



VOLT 220-240V 50-60Hz | BEAM ANGLE 300° | PF >0.65 | Ra >80 | Hg 0.00% | 25000 ON-OFF | 25000h LIFE TIME | START TIME min: 0.5 sec | -30°C ~ +45°C OPERATING TEMP.

| BARCODE  | CODE      | BASE | TYPE | WATT | =WATT | KELVIN | LUMEN | mm    | PACKING | PRICE (€) |
|--|-----------|------|------|------|-------|--------|-------|-------|---------|-----------|
| • ΥΛΙΚΟ ΚΑΤΑΣΚΕΥΗΣ: ΠΛΑΣΤΙΚΟ ΜΕ ΨΥΚΤΡΑ ΑΛΟΥΜΙΝΙΟΥ • PRODUCTION MATERIAL: PLASTIC WITH ALUMINIUM HEATSINK |           |      |      |      |       |        |       |       |         |           |
| 5206139097309  | 147-80230 | E14  | G45  | 5W   | 45W   | 6500K  | 400   | 83 45 | 1/10/50 | 2.05      |
| 5206139071194  | 147-82312 | E14  | G45  | 5W   | 45W   | 4000K  | 400   | 83 45 | 1/10/50 | 2.05      |
| 5206139097330  | 147-80231 | E14  | G45  | 5W   | 45W   | 2700K  | 400   | 83 45 | 1/10/50 | 2.05      |
| 5206139097361  | 147-80232 | E27  | G45  | 5W   | 45W   | 6500K  | 400   | 83 45 | 1/10/50 | 2.05      |
| 5206139071224  | 147-82342 | E27  | G45  | 5W   | 45W   | 4000K  | 400   | 83 45 | 1/10/50 | 2.05      |
| 5206139097392  | 147-80233 | E27  | G45  | 5W   | 45W   | 2700K  | 400   | 83 45 | 1/10/50 | 2.05      |
| 5206139021786  | 147-80234 | E14  | G45  | 7W   | 60W   | 6500K  | 630   | 83 45 | 1/10/50 | 2.35      |
| 5206139021793  | 147-80235 | E14  | G45  | 7W   | 60W   | 4000K  | 630   | 83 45 | 1/10/50 | 2.35      |
| 5206139021847  | 147-80236 | E14  | G45  | 7W   | 60W   | 2700K  | 630   | 83 45 | 1/10/50 | 2.35      |
| 5206139038920  | 147-80237 | E27  | G45  | 7W   | 60W   | 6500K  | 630   | 83 45 | 1/10/50 | 2.35      |
| 5206139038968  | 147-80238 | E27  | G45  | 7W   | 60W   | 4000K  | 630   | 83 45 | 1/10/50 | 2.35      |
| 5206139038975  | 147-80239 | E27  | G45  | 7W   | 60W   | 2700K  | 630   | 83 45 | 1/10/50 | 2.35      |

| BARCODE  | CODE      | BASE | TYPE | WATT | =WATT | KELVIN | LUMEN | mm    | PACKING | PRICE (€) |
|--|-----------|------|------|------|-------|--------|-------|-------|---------|-----------|
| • ΥΛΙΚΟ ΚΑΤΑΣΚΕΥΗΣ: ΠΛΑΣΤΙΚΟ ΜΕ ΚΕΡΑΜΙΚΗ ΒΑΣΗ • PRODUCTION MATERIAL: PLASTIC WITH CERAMIC BASE |           |      |      |      |       |        |       |       |         |           |
| 5207227072796  | 147-77350 | E14  | G45  | 10W  | 75W   | 6500K  | 1000  | 89 45 | 1/10/50 | 5.80      |
| 5207227072802  | 147-77351 | E14  | G45  | 10W  | 75W   | 4000K  | 1000  | 89 45 | 1/10/50 | 5.80      |
| 5207227072819  | 147-77353 | E14  | G45  | 10W  | 75W   | 2700K  | 1000  | 89 45 | 1/10/50 | 5.80      |
| 5207227072826  | 147-77354 | E27  | G45  | 10W  | 75W   | 6500K  | 1000  | 89 45 | 1/10/50 | 5.80      |
| 5207227072833  | 147-77355 | E27  | G45  | 10W  | 75W   | 4000K  | 1000  | 89 45 | 1/10/50 | 5.80      |
| 5207227072840  | 147-77357 | E27  | G45  | 10W  | 75W   | 2700K  | 1000  | 89 45 | 1/10/50 | 5.80      |

• BLISTER PACKING

| BARCODE       | CODE      | BASE | TYPE | WATT | =WATT | KELVIN | LUMEN | mm    | PACKING | PRICE (€) |
|---------------|-----------|------|------|------|-------|--------|-------|-------|---------|-----------|
| 5206139008473 | 147-84430 | E14  | G45  | 4W   | 40W   | 6500K  | 380   | 83 45 | 1/10/50 | 2.15      |
| 5206139006349 | 147-84431 | E14  | G45  | 4W   | 40W   | 2700K  | 380   | 83 45 | 1/10/50 | 2.15      |
| 5206139008398 | 147-84440 | E27  | G45  | 4W   | 40W   | 6500K  | 380   | 83 45 | 1/10/50 | 2.15      |
| 5206139008442 | 147-84441 | E27  | G45  | 4W   | 40W   | 2700K  | 380   | 83 45 | 1/10/50 | 2.15      |
| 5206139028891 | 147-84432 | E14  | G45  | 6W   | 50W   | 6500K  | 470   | 83 45 | 1/10/50 | 2.45      |
| 5206139028945 | 147-84433 | E14  | G45  | 6W   | 50W   | 2700K  | 470   | 83 45 | 1/10/50 | 2.45      |
| 5206139028976 | 147-84442 | E27  | G45  | 6W   | 50W   | 6500K  | 470   | 83 45 | 1/10/50 | 2.45      |
| 5206139029034 | 147-84443 | E27  | G45  | 6W   | 50W   | 2700K  | 470   | 83 45 | 1/10/50 | 2.45      |

- LED SMD MINI GLOBE BULBS
- ΛΑΜΠΤΗΡΕΣ ΚΟΙΝΟΙ ΣΦΑΙΡΙΚΟΙ MINI LED SMD  
G45 - E27 / E14

PRODUCTION MATERIAL: **PLASTIC WITH ALUMINIUM HEATSINK**  
ΥΛΙΚΟ ΚΑΤΑΣΚΕΥΗΣ: **ΠΛΑΣΤΙΚΟ ΜΕ ΨΥΚΤΡΑ ΑΛΟΥΜΙΝΙΟΥ**

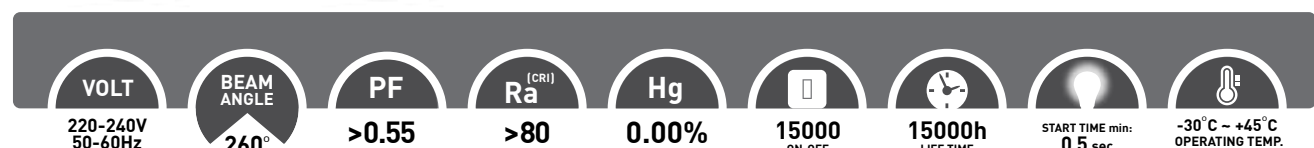

| BARCODE       | CODE      | BASE | TYPE | WATT =WATT | KELVIN | LUMEN | mm        | PACKING  | PRICE (€) |
|---------------|-----------|------|------|------------|--------|-------|-----------|----------|-----------|
| 5206139084651 | 180-80401 | E14  | G45  | 8W 70W     | 6500K  | 690   | 88.2 46.8 | 1/10/50  | 2.00      |
| 5206139084668 | 180-80421 | E14  | G45  | 8W 70W     | 2700K  | 690   | 88.2 46.8 | 1/10/50  | 2.00      |
| 5206139084675 | 180-80431 | E27  | G45  | 8W 70W     | 6500K  | 690   | 83 45     | 1/10/100 | 2.00      |
| 5206139084682 | 180-80451 | E27  | G45  | 8W 70W     | 2700K  | 690   | 83 45     | 1/10/100 | 2.00      |

- LED SMD MINI GLOBE BULBS
- ΛΑΜΠΤΗΡΕΣ ΚΟΙΝΟΙ ΣΦΑΙΡΙΚΟΙ LED SMD  
G45 - E27 / E14
- MULTI-PACK **BLISTER**

PRODUCTION MATERIAL: **PLASTIC WITH ALUMINIUM HEATSINK**  
ΥΛΙΚΟ ΚΑΤΑΣΚΕΥΗΣ: **ΠΛΑΣΤΙΚΟ ΜΕ ΨΥΚΤΡΑ ΑΛΟΥΜΙΝΙΟΥ**

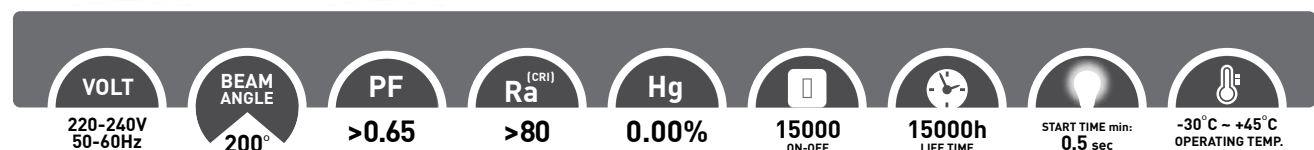

| BARCODE       | CODE      | BASE | TYPE | WATT =WATT | KELVIN | LUMEN | mm    | PACKING | PRICE (€) |
|---------------|-----------|------|------|------------|--------|-------|-------|---------|-----------|
| 5207227033513 | 180-80460 | E14  | G45  | 5W 45W     | 6500K  | 400   | 78 45 | 1/5/30  | 4.90      |
| 5207227033544 | 180-80461 | E14  | G45  | 5W 45W     | 3000K  | 400   | 78 45 | 1/5/30  | 4.90      |
| 5207227037115 | 180-80462 | E27  | G45  | 5W 45W     | 6500K  | 400   | 78 45 | 1/5/30  | 4.90      |
| 5207227037122 | 180-80463 | E27  | G45  | 5W 45W     | 3000K  | 400   | 78 45 | 1/5/30  | 4.90      |

- LED SMD GLOBE BULBS
- ΛΑΜΠΤΗΡΑΣ ΚΟΙΝΟΣ ΓΛΟΜΠΟΣ LED SMD  
G95 / G120 - E27

PRODUCTION MATERIAL: **PLASTIC WITH ALUMINIUM HEATSINK**  
ΥΛΙΚΟ ΚΑΤΑΣΚΕΥΗΣ: **ΠΛΑΣΤΙΚΟ ΜΕ ΨΥΚΤΡΑ ΑΛΟΥΜΙΝΙΟΥ**

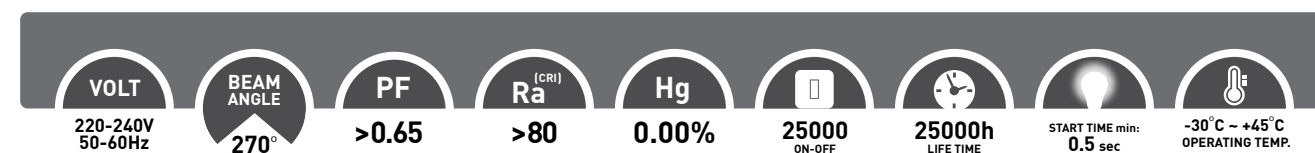

| BARCODE       | CODE      | BASE | TYPE | WATT =WATT | KELVIN | LUMEN | mm      | PACKING | PRICE (€) |
|---------------|-----------|------|------|------------|--------|-------|---------|---------|-----------|
| 5206139014009 | 147-84490 | E27  | G95  | 12W 80W    | 6500K  | 1200  | 142 95  | 1/5/20  | 8.35      |
| 5207227037344 | 147-84498 | E27  | G95  | 12W 80W    | 4000K  | 1200  | 142 95  | 1/5/20  | 8.35      |
| 5206139014023 | 147-84491 | E27  | G95  | 12W 80W    | 2700K  | 1200  | 142 95  | 1/5/20  | 8.35      |
| 5206139087713 | 147-84492 | E27  | G120 | 18W 100W   | 6500K  | 1500  | 156 120 | 1/5/20  | 11.75     |
| 5207227064357 | 147-77407 | E27  | G120 | 18W 100W   | 4000K  | 1500  | 156 120 | 1/5/20  | 11.75     |
| 5206139089090 | 147-84493 | E27  | G120 | 18W 100W   | 2700K  | 1500  | 156 120 | 1/5/20  | 11.75     |
| 5207227020339 | 147-84496 | E27  | G120 | 25W 155W   | 6500K  | 2400  | 160 120 | 1/5/20  | 13.45     |
| 5207227064388 | 147-77413 | E27  | G120 | 25W 155W   | 4000K  | 2400  | 160 120 | 1/5/20  | 13.45     |
| 5207227020360 | 147-84497 | E27  | G120 | 25W 155W   | 2700K  | 2400  | 160 120 | 1/5/20  | 13.45     |



### LED SMD BULBS • ΛΑΜΠΤΗΡΕΣ LED SMD / R50 - E14

PRODUCTION MATERIAL: **PLASTIC WITH ALUMINIUM HEATSINK**  
ΥΛΙΚΟ ΚΑΤΑΣΚΕΥΗΣ: **ΠΛΑΣΤΙΚΟ ΜΕ ΨΥΚΤΡΑ ΑΛΟΥΜΙΝΙΟΥ**



VOLT: 220-240V 50-60Hz  
BEAM ANGLE: 120°  
PF: >0.55  
Ra (CRI): >80  
Hg: 0.00%  
25000 ON-OFF  
25000h LIFE TIME  
START TIME min: 0.5 sec  
-30°C ~ +45°C OPERATING TEMP.

| BARCODE       | CODE      | BASE | TYPE | WATT | =WATT | KELVIN | LUMEN | mm | PACKING | PRICE (€) |      |
|---------------|-----------|------|------|------|-------|--------|-------|----|---------|-----------|------|
| 5206139014856 | 147-84480 | E14  | R50  | 8W   | 64W   | 6500K  | 640   | 86 | 50      | 1/10/30   | 4.00 |
| 5207227072857 | 147-77451 | E14  | R50  | 8W   | 64W   | 4000K  | 640   | 86 | 50      | 1/10/30   | 4.00 |
| 5206139014917 | 147-84482 | E14  | R50  | 8W   | 64W   | 2700K  | 640   | 86 | 50      | 1/10/30   | 4.00 |



### LED SMD BULBS • ΛΑΜΠΤΗΡΕΣ LED SMD / R63 - E27

PRODUCTION MATERIAL: **PLASTIC WITH ALUMINIUM HEATSINK**  
ΥΛΙΚΟ ΚΑΤΑΣΚΕΥΗΣ: **ΠΛΑΣΤΙΚΟ ΜΕ ΨΥΚΤΡΑ ΑΛΟΥΜΙΝΙΟΥ**



VOLT: 220-240V 50-60Hz  
BEAM ANGLE: 120°  
PF: >0.65  
Ra (CRI): >80  
Hg: 0.00%  
25000 ON-OFF  
25000h LIFE TIME  
START TIME min: 0.5 sec  
-30°C ~ +45°C OPERATING TEMP.

| BARCODE       | CODE      | BASE | TYPE | WATT | =WATT | KELVIN | LUMEN | mm  | PACKING | PRICE (€) |      |
|---------------|-----------|------|------|------|-------|--------|-------|-----|---------|-----------|------|
| 5206139014979 | 147-84483 | E27  | R63  | 10W  | 120W  | 6500K  | 800   | 101 | 63      | 1/10/30   | 4.25 |
| 5207227072864 | 147-77454 | E27  | R63  | 10W  | 120W  | 4000K  | 800   | 101 | 63      | 1/10/30   | 4.25 |
| 5206139013996 | 147-84486 | E27  | R63  | 10W  | 120W  | 2700K  | 800   | 101 | 63      | 1/10/30   | 4.25 |



### LED SMD BULBS • ΛΑΜΠΤΗΡΕΣ LED SMD / R80 - E27

PRODUCTION MATERIAL: **PLASTIC WITH ALUMINIUM HEATSINK**  
ΥΛΙΚΟ ΚΑΤΑΣΚΕΥΗΣ: **ΠΛΑΣΤΙΚΟ ΜΕ ΨΥΚΤΡΑ ΑΛΟΥΜΙΝΙΟΥ**



VOLT: 220-240V 50-60Hz  
BEAM ANGLE: 120°  
PF: >0.65  
Ra (CRI): >80  
Hg: 0.00%  
25000 ON-OFF  
25000h LIFE TIME  
START TIME min: 0.5 sec  
-30°C ~ +45°C OPERATING TEMP.

| BARCODE       | CODE      | BASE | TYPE | WATT | =WATT | KELVIN | LUMEN | mm  | PACKING | PRICE (€) |      |
|---------------|-----------|------|------|------|-------|--------|-------|-----|---------|-----------|------|
| 5207227060694 | 147-77456 | E27  | R80  | 12W  | 150W  | 6500K  | 1100  | 120 | 80      | 1/10/30   | 7.15 |
| 5207227064098 | 147-77457 | E27  | R80  | 12W  | 150W  | 4000K  | 1100  | 120 | 80      | 1/10/30   | 7.15 |
| 5207227060724 | 147-77458 | E27  | R80  | 12W  | 150W  | 2700K  | 1100  | 120 | 80      | 1/10/30   | 7.15 |





LED SMD BULBS • ΛΑΜΠΤΗΡΕΣ LED SMD  
T5 • 60 - 90 - 120 - 150 cm

PRODUCTION MATERIAL: **GLASS + PLASTIC BASE**  
ΥΛΙΚΟ ΚΑΤΑΣΚΕΥΗΣ: **ΓΥΑΛΙ + ΠΛΑΣΤΙΚΗ ΒΑΣΗ**

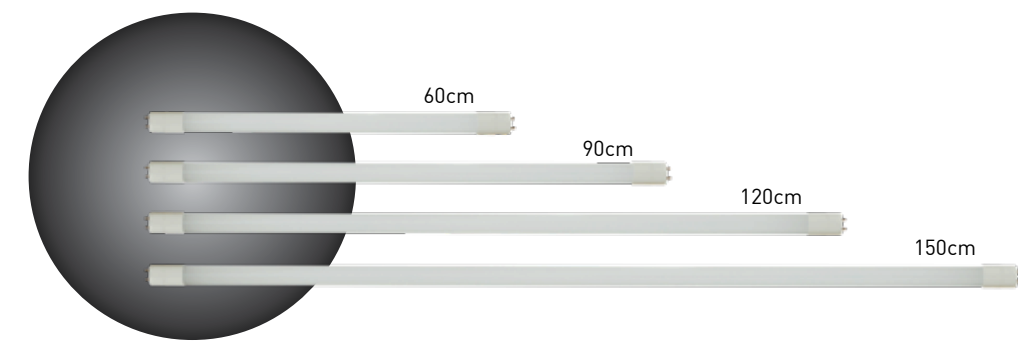

- PRO** (with 'SMD' subtext)
- Sleeve PACKING** (with bulb icon)
- A+** ENERGY CLASS
- 90%** ENERGY SAVING
- NOT DIMMABLE**
- 2 YEARS** WARRANTY

- VOLT**: 175-265V 50-60Hz
- BEAM ANGLE**: 220°
- PF**: >0.90
- Ra** (CRI): >80
- Hg**: 0.00%
- 40000 ON-OFF**
- 25000h LIFE TIME**
- START TIME min: 0.5 sec**
- 30°C ~ +45°C OPERATING TEMP.**

| BARCODE       | CODE      | BASE | TYPE | WATT | KELVIN | LUMEN | mm   | mm | PACKING | PRICE (€) |
|---------------|-----------|------|------|------|--------|-------|------|----|---------|-----------|
| 5206139068446 | 147-84771 | G5   | T5   | 9W   | 4000K  | 900   | 600  | 20 | 1/25/50 | 8.80      |
| 5206139077028 | 147-84774 | G5   | T5   | 14W  | 4000K  | 1400  | 900  | 20 | 1/25/50 | 9.65      |
| 5206139077059 | 147-84777 | G5   | T5   | 18W  | 4000K  | 1800  | 1200 | 20 | 1/25/50 | 10.80     |
| 5206139077097 | 147-84780 | G5   | T5   | 22W  | 4000K  | 2200  | 1500 | 20 | 1/25/50 | 18.25     |

LED

SMD Common Bulbs Type: T

Discover our Collection ►

LED SMD BULBS • ΛΑΜΠΤΗΡΕΣ LED SMD  
T8-G13 / "2 in 1" / 60 cm

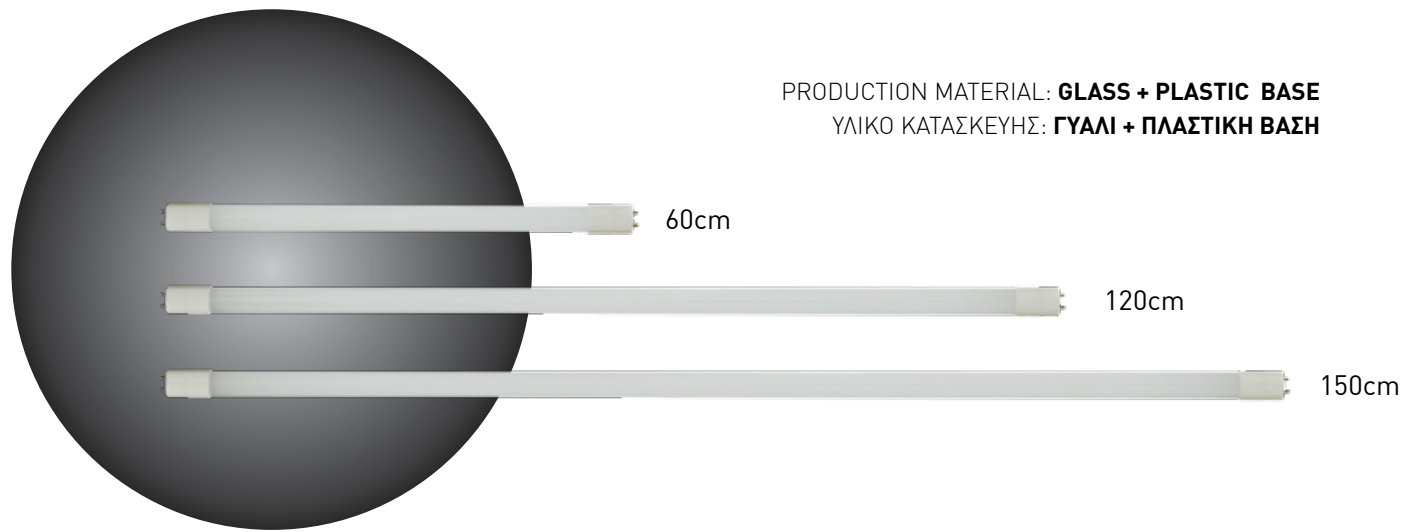

PRODUCTION MATERIAL: GLASS + PLASTIC BASE  
ΥΛΙΚΟ ΚΑΤΑΣΚΕΥΗΣ: ΓΥΑΛΙ + ΠΛΑΣΤΙΚΗ ΒΑΣΗ

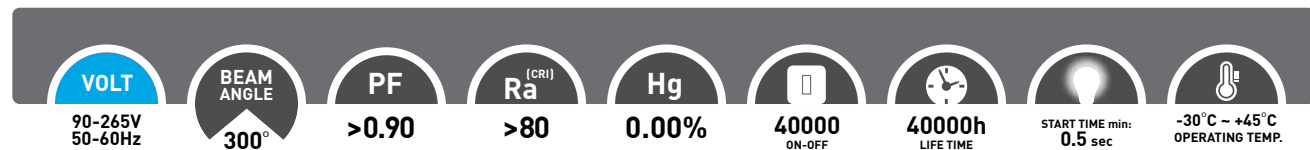

| BARCODE       | CODE      | BASE | TYPE | WATT | KELVIN | LUMEN | mm        | PACKING | PRICE (€) |
|---------------|-----------|------|------|------|--------|-------|-----------|---------|-----------|
| 5207227059384 | 147-84710 | G13  | T8   | 10W  | 6500K  | 1050  | 604 28    | 1/10    | 5.50      |
| 5207227059407 | 147-84711 | G13  | T8   | 10W  | 4000K  | 1050  | 604 28    | 1/10    | 5.50      |
| 5207227059421 | 147-84712 | G13  | T8   | 10W  | 3000K  | 1050  | 604 28    | 1/10    | 5.50      |
| 5207227059445 | 147-84713 | G13  | T8   | 18W  | 6500K  | 1900  | 1213.6 28 | 1/10    | 7.20      |
| 5207227059469 | 147-84714 | G13  | T8   | 18W  | 4000K  | 1900  | 1213.6 28 | 1/10    | 7.20      |
| 5207227059483 | 147-84715 | G13  | T8   | 18W  | 3000K  | 1900  | 1213.6 28 | 1/10    | 7.20      |
| 5207227059506 | 147-84716 | G13  | T8   | 24W  | 6500K  | 2520  | 1514.2 28 | 1/10    | 11.70     |
| 5207227059520 | 147-84717 | G13  | T8   | 24W  | 4000K  | 2520  | 1514.2 28 | 1/10    | 11.70     |
| 5207227059544 | 147-84718 | G13  | T8   | 24W  | 3000K  | 2520  | 1514.2 28 | 1/10    | 11.70     |

- ΓΕΦΥΡΑ LED ΤΥΠΟΥ ΣΤΑΡΤΕΡ
- LED STARTER FOR T8 LED TUBES

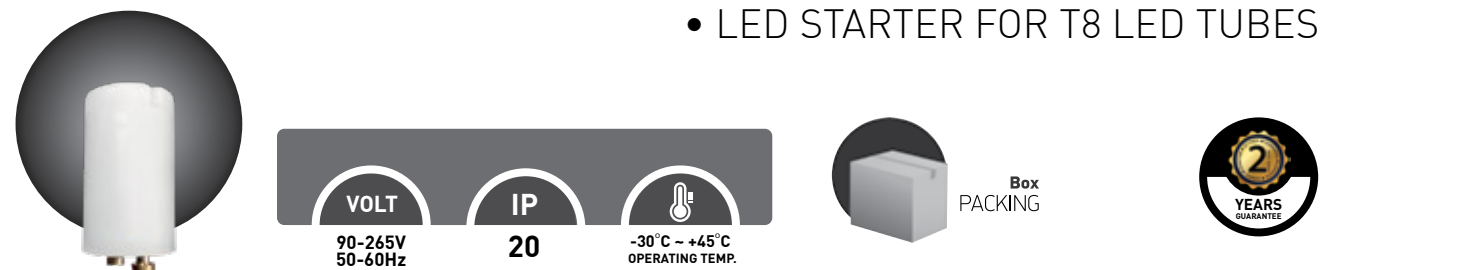

| BARCODE       | CODE      | PACKING | PRICE (€) |
|---------------|-----------|---------|-----------|
| 5207227033957 | 147-02210 | 25/500  | 0.35      |

# T8-G13

## 2in1

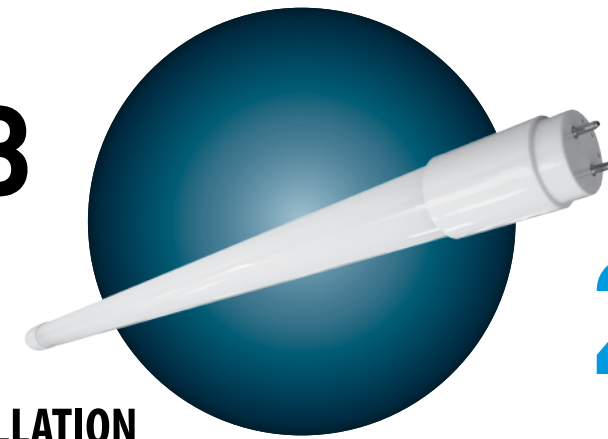

## 2ΣΕ1

### WIRING AND INSTALLATION

FOR LED LIGHTING WITH G13 BASE HOLDER

Just make sure that the end marked L & N (black line) is connected to the end of the luminaire where the operating voltage is provided and not vice versa, according to drawing 1. Incorrect connection may cause damage to the lamp and the fixture and invalidates the warranty.

DRAWING 1

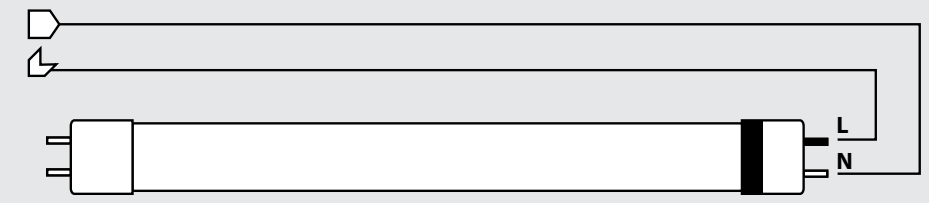

FOR FLUORESCENT LIGHTING WITH G13 BASE HOLDER

For fluorescent lamps it is not necessary to change the old magnetic ballast. For installation, follow the connectivity from drawing 2. To replace fluorescent lamps, connect a LED starter (sold separately) and install the lamp. When installing, be sure to disconnect the power supply.

DRAWING 2

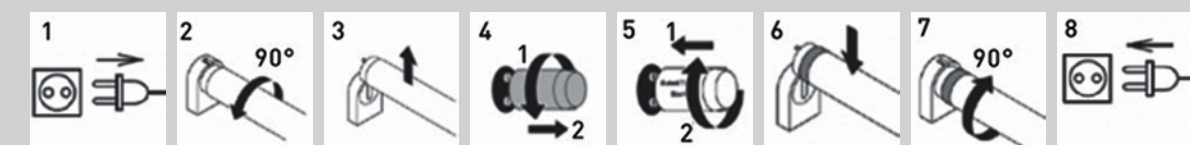

It only works with magnetic ballast. In the case of an electronic ballast, then it should be removed and drawing 1 should be followed. No need for re-wiring. Directly install the lamp on.

### ΣΥΝΔΕΣΙΜΟΤΗΤΑ ΚΑΙ ΕΓΚΑΤΑΣΤΑΣΗ

ΓΙΑ ΦΩΤΙΣΤΙΚΑ LED ΜΕ ΝΤΟΥΓΙ G13

Αλλά βεβαιωθείτε ότι το άκρο με σήμανση L & N (μαύρη γραμμή) θα συνδεθεί στο άκρο του φωτιστικού όπου παρέχεται η τάση λειτουργίας και όχι αντίστροφα, όπως στο σχεδιάγραμμα 1. Εσφαλμένη σύνδεση μπορεί να προκαλέσει ζημιά στο φωτιστικό και τη λάμπα ενώ ακυρώνει και την εγγύηση.

ΣΧΕΔΙΑΓΡΑΜΜΑ 1

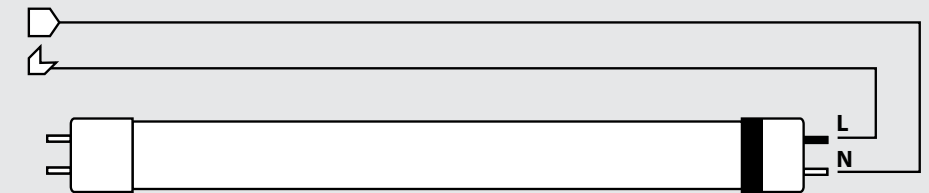

ΓΙΑ ΦΩΤΙΣΤΙΚΑ ΦΘΟΡΙΟΥ ΜΕ ΝΤΟΥΓΙ G13

Για τα φωτιστικά φθορίου δεν είναι απαραίτητο να αλλάξει το παλιό μαγνητικό ballast. Για την εγκατάσταση ακολουθήστε την συνδεσιμότητα από το σχεδιάγραμμα 2. Για την αντικατάσταση λαμπτήρων φθορίου, συνδέστε ένα LED starter (πωλείται ξεχωριστά) και τοποθετήστε τη λάμπα. Κατά την τοποθέτηση βεβαιωθείτε ότι έχετε διακόψει την παροχή ρεύματος.

ΣΧΕΔΙΑΓΡΑΜΜΑ 2

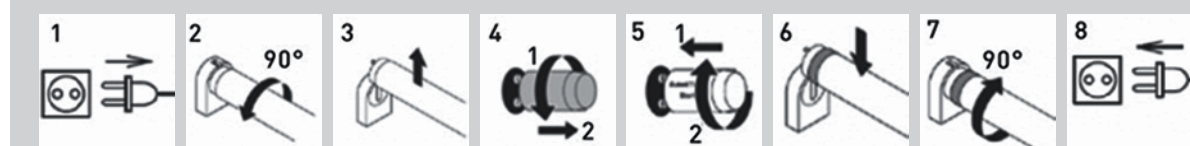

Λειτουργεί μόνο με μαγνητικό ballast. Σε περίπτωση ηλεκτρονικού, τότε αυτό θα πρέπει να αφαιρεθεί και να εφαρμοστεί η σύνδεση στο σχεδιάγραμμα 1.  
Δεν υπάρχει ανάγκη για επανα-καλωδίωση.  
Τοποθετήστε απευθείας τη λυχνία.

LED SMD BULBS • ΛΑΜΠΤΗΡΕΣ LED SMD  
T8-G13 / "2 in 1" / 45-60-90-100-120-150 cm

PRODUCTION MATERIAL: GLASS + PLASTIC BASE  
ΥΛΙΚΟ ΚΑΤΑΣΚΕΥΗΣ: ΓΥΑΛΙ + ΠΛΑΣΤΙΚΗ ΒΑΣΗ

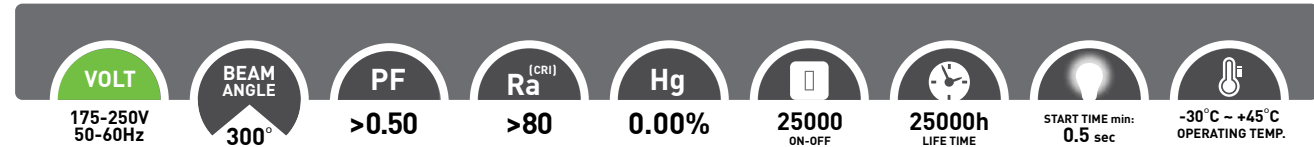
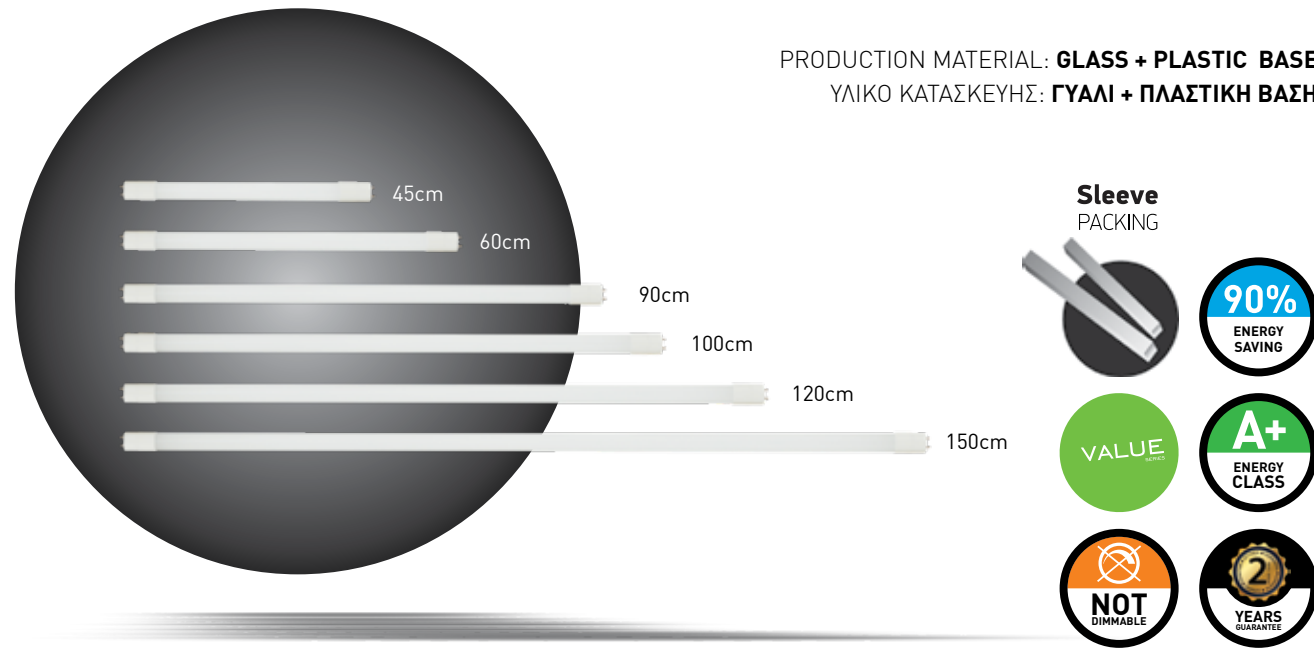

| BARCODE       | CODE      | BASE | TYPE | WATT | KELVIN | LUMEN | mm   | Ø  | PACKING | PRICE (€) |
|---------------|-----------|------|------|------|--------|-------|------|----|---------|-----------|
| 5207227064418 | 180-77740 | G13  | T8   | 5W   | 6500K  | 525   | 450  | 28 | 1/10    | 4.05      |
| 5207227064425 | 180-77741 | G13  | T8   | 5W   | 4000K  | 525   | 450  | 28 | 1/10    | 4.05      |
| 5207227037764 | 180-82750 | G13  | T8   | 10W  | 6500K  | 1050  | 600  | 28 | 1/10    | 4.15      |
| 5207227033926 | 180-82751 | G13  | T8   | 10W  | 4000K  | 1050  | 600  | 28 | 1/10    | 4.15      |
| 5207227037788 | 180-82760 | G13  | T8   | 14W  | 6500K  | 1470  | 900  | 28 | 1/10    | 4.95      |
| 5207227037801 | 180-82761 | G13  | T8   | 14W  | 4000K  | 1470  | 900  | 28 | 1/10    | 4.95      |
| 5207227064432 | 180-77749 | G13  | T8   | 15W  | 6500K  | 1575  | 1000 | 28 | 1/10    | 5.00      |
| 5207227064449 | 180-77750 | G13  | T8   | 15W  | 4000K  | 1575  | 1000 | 28 | 1/10    | 5.00      |
| 5207227037825 | 180-82770 | G13  | T8   | 18W  | 6500K  | 1900  | 1200 | 28 | 1/10    | 5.10      |
| 5207227033940 | 180-82771 | G13  | T8   | 18W  | 4000K  | 1900  | 1200 | 28 | 1/10    | 5.10      |
| 5207227037849 | 180-82780 | G13  | T8   | 24W  | 6500K  | 2520  | 1500 | 28 | 1/10    | 9.00      |
| 5207227037863 | 180-82781 | G13  | T8   | 24W  | 4000K  | 2520  | 1500 | 28 | 1/10    | 9.00      |

- ΓΕΦΥΡΑ LED ΤΥΠΟΥ ΣΤΑΡΤΕΡ
- LED STARTER FOR T8 LED TUBES

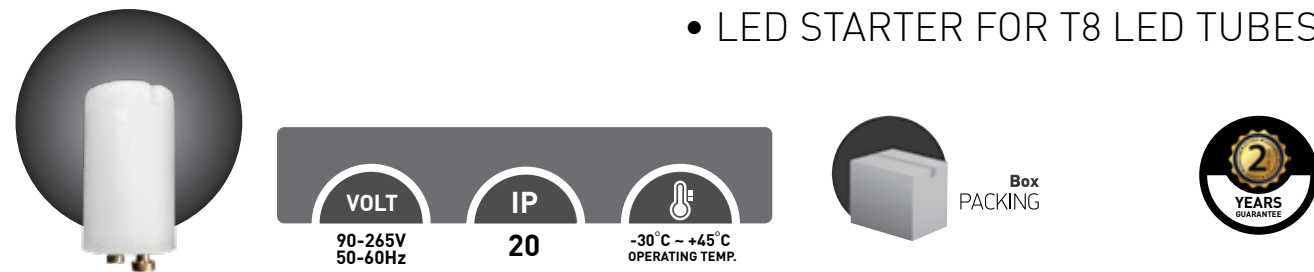

| BARCODE       | CODE      | PACKING | PRICE (€) |
|---------------|-----------|---------|-----------|
| 5207227033957 | 147-02210 | 25/500  | 0.35      |

# T8-G13

## 2in1

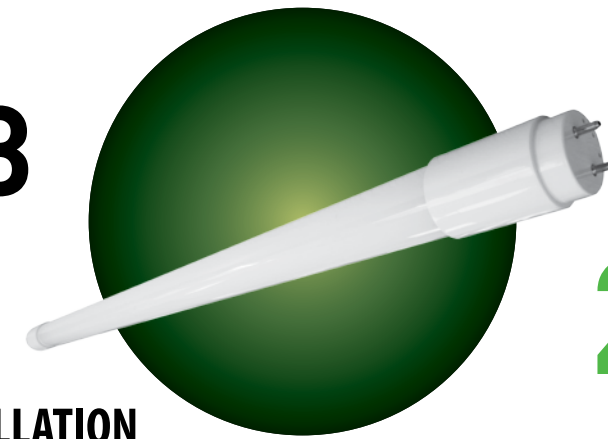

## 2ΣΕ1

### WIRING AND INSTALLATION

FOR LED LIGHTING WITH G13 BASE HOLDER

Just make sure that the end marked L & N (black line) is connected to the end of the luminaire where the operating voltage is provided and not vice versa, according to drawing 1. Incorrect connection may cause damage to the lamp and the fixture and invalidates the warranty.

DRAWING 1

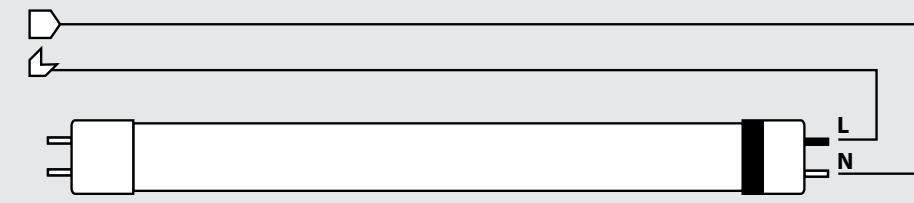

FOR FLUORESCENT LIGHTING WITH G13 BASE HOLDER

For fluorescent lamps it is not necessary to change the old magnetic ballast. For installation, follow the connectivity from drawing 2. To replace fluorescent lamps, connect a LED starter (sold separately) and install the lamp. When installing, be sure to disconnect the power supply.

DRAWING 2

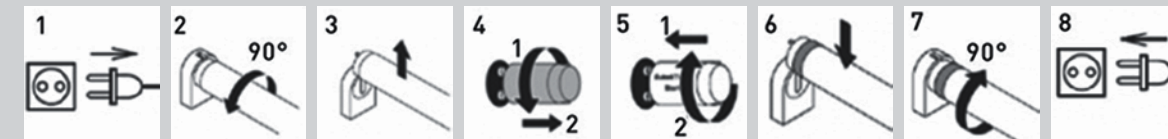

It only works with magnetic ballast. In the case of an electronic ballast, then it should be removed and drawing 1 should be followed. No need for re-wiring. Directly install the lamp on.

### ΣΥΝΔΕΣΙΜΟΤΗΤΑ ΚΑΙ ΕΓΚΑΤΑΣΤΑΣΗ

ΓΙΑ ΦΩΤΙΣΤΙΚΑ LED ΜΕ ΝΤΟΥΓΙ G13

Απλά βεβαιωθείτε ότι το άκρο με σήμανση L & N (μαύρη γραμμή) θα συνδεθεί στο άκρο του φωτιστικού όπου παρέχεται η τάση λειτουργίας και όχι αντίστροφα, όπως στο σχεδιάγραμμα 1. Εσφαλμένη σύνδεση μπορεί να προκαλέσει ζημιά στο φωτιστικό και τη λάμπα ενώ ακυρώνει και την εγγύηση.

ΣΧΕΔΙΑΓΡΑΜΜΑ 1

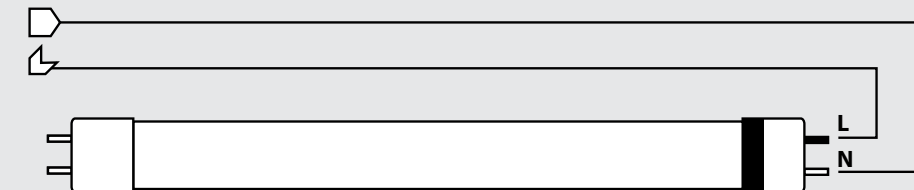

ΓΙΑ ΦΩΤΙΣΤΙΚΑ ΦΘΟΡΙΟΥ ΜΕ ΝΤΟΥΓΙ G13

Για τα φωτιστικά φθορίου δεν είναι απαραίτητο να αλλάξει το παλιό μαγνητικό ballast. Για την εγκατάσταση ακολουθήστε την συνδεσιμότητα από το σχεδιάγραμμα 2. Για την αντικατάσταση λαμπτήρων φθορίου, συνδέστε ένα LED starter (πωλείται ξεχωριστά) και τοποθετήστε τη λάμπα. Κατά την τοποθέτηση βεβαιωθείτε ότι έχετε διακόψει την παροχή ρεύματος.

ΣΧΕΔΙΑΓΡΑΜΜΑ 2



Λειτουργεί μόνο με μαγνητικό ballast. Σε περίπτωση ηλεκτρονικού, τότε αυτό θα πρέπει να αφαιρεθεί και να εφαρμοστεί η σύνδεση στο σχεδιάγραμμα 1. Δεν υπάρχει ανάγκη για επανα-καλωδίωση. Τοποθετήστε απευθείας τη λυχνία.

TYPE: MR11 / BASE: GU4



TYPE: MR16 / BASE: GU5.3



TYPE: GU11 / BASE: GU10



TYPE: GU10 / BASE: GU10



TYPE: GU10 / BASE: GU10



TYPE: GU10 / BASE: GU10



Types: MR11 / MR16 / GU10 / GU11

**LED**

SMD Common Bulbs

Discover our Collection ►

LED SMD BULBS • ΛΑΜΠΤΗΡΕΣ LED SMD • MR11-GU4 • 35°

PRODUCTION MATERIAL: **PLASTIC WITH ALUMINIUM HEATSINK**  
ΥΛΙΚΟ ΚΑΤΑΣΚΕΥΗΣ: **ΠΛΑΣΤΙΚΟ ΜΕ ΨΥΚΤΡΑ ΑΛΟΥΜΙΝΙΟΥ**

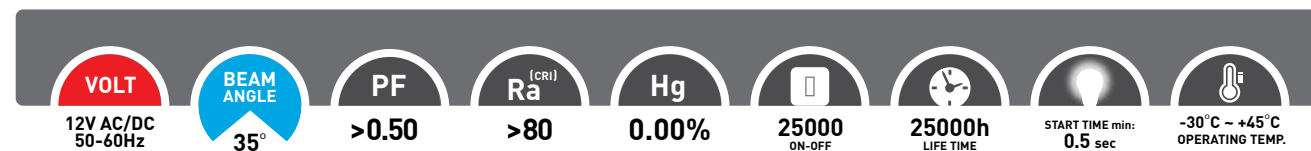
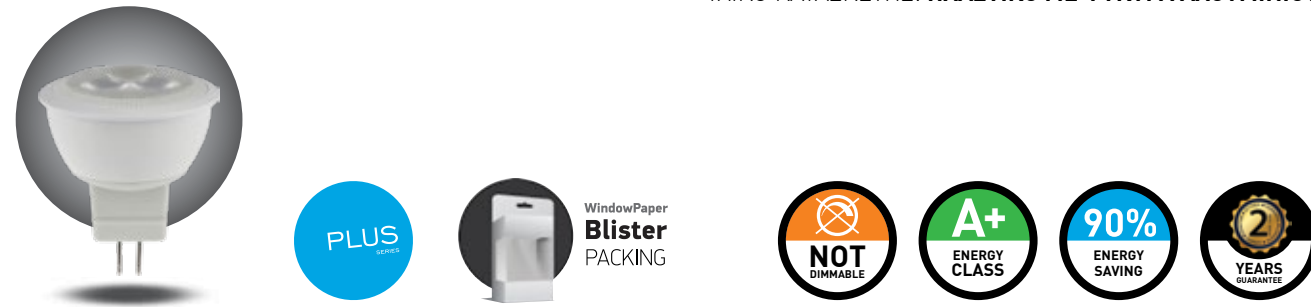

| BARCODE       | CODE      | BASE | TYPE | WATT =WATT | KELVIN | LUMEN | mm    | PACKING  | PRICE (€) |
|---------------|-----------|------|------|------------|--------|-------|-------|----------|-----------|
| 5206139031150 | 147-84202 | GU4  | MR11 | 3W 25W     | 6500K  | 220   | 35 35 | 1/10/100 | 5.05      |
| 5206139031181 | 147-84203 | GU4  | MR11 | 3W 25W     | 2700K  | 220   | 35 35 | 1/10/100 | 5.05      |

LED SMD BULBS • ΛΑΜΠΤΗΡΕΣ LED SMD  
MR16 - GU5.3 • 105°

PRODUCTION MATERIAL: **PLASTIC WITH ALUMINIUM HEATSINK**  
ΥΛΙΚΟ ΚΑΤΑΣΚΕΥΗΣ: **ΠΛΑΣΤΙΚΟ ΜΕ ΨΥΚΤΡΑ ΑΛΟΥΜΙΝΙΟΥ**

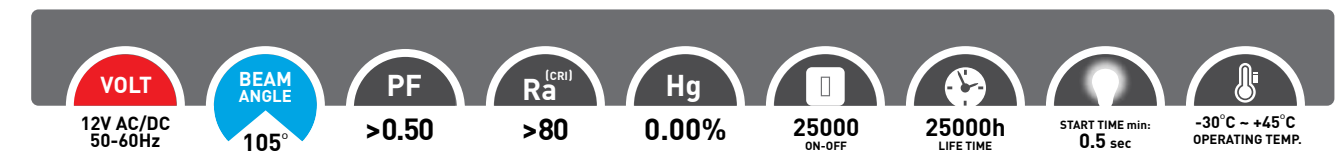
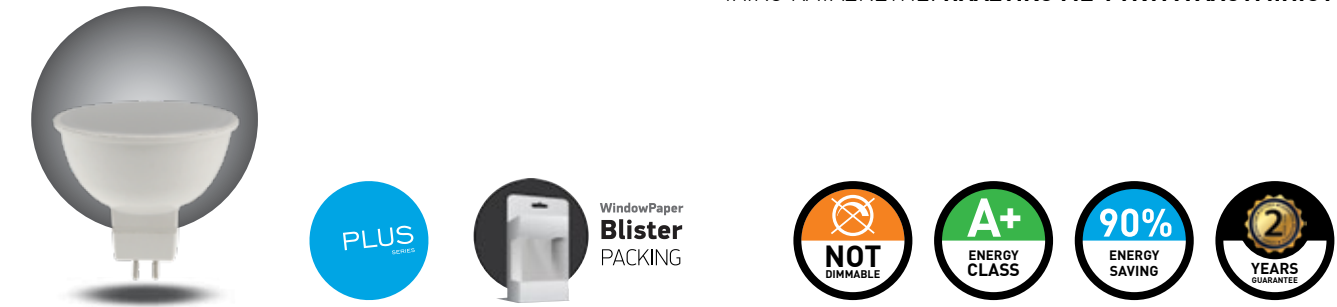

| BARCODE       | CODE      | BASE  | TYPE | WATT =WATT | KELVIN | LUMEN | mm    | PACKING  | PRICE (€) |
|---------------|-----------|-------|------|------------|--------|-------|-------|----------|-----------|
| 5207227011016 | 147-84260 | GU5.3 | MR16 | 6W 55W     | 6500K  | 480   | 48 50 | 1/10/100 | 3.60      |
| 5206139078650 | 147-84261 | GU5.3 | MR16 | 6W 55W     | 4000K  | 480   | 48 50 | 1/10/100 | 3.60      |
| 5207227005145 | 147-84262 | GU5.3 | MR16 | 6W 55W     | 2700K  | 480   | 48 50 | 1/10/100 | 3.60      |

LED SMD BULBS • ΛΑΜΠΤΗΡΕΣ LED SMD • GU11- G10 • 120°

PRODUCTION MATERIAL: **PLASTIC WITH ALUMINIUM HEATSINK**  
ΥΛΙΚΟ ΚΑΤΑΣΚΕΥΗΣ: **ΠΛΑΣΤΙΚΟ ΜΕ ΨΥΚΤΡΑ ΑΛΟΥΜΙΝΙΟΥ**

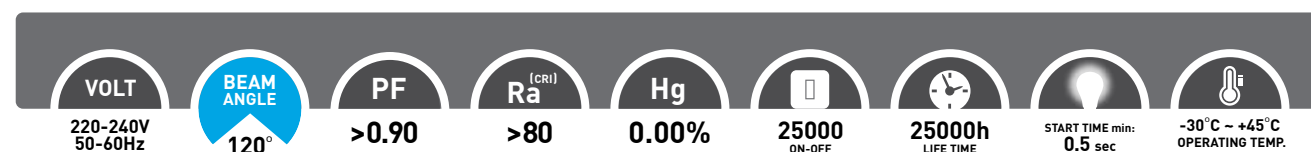

| BARCODE       | CODE      | BASE | TYPE | WATT =WATT | KELVIN | LUMEN | mm    | PACKING  | PRICE (€) |
|---------------|-----------|------|------|------------|--------|-------|-------|----------|-----------|
| 5207227022135 | 147-84204 | GU10 | GU11 | 3W 25W     | 6500K  | 190   | 46 35 | 1/10/100 | 4.80      |
| 5207227022166 | 147-84205 | GU10 | GU11 | 3W 25W     | 2700K  | 190   | 46 35 | 1/10/100 | 4.80      |

LED SMD BULBS • ΛΑΜΠΤΗΡΕΣ LED SMD  
MR16 - GU5.3 • 38°

PRODUCTION MATERIAL: **PLASTIC WITH ALUMINIUM HEATSINK**  
ΥΛΙΚΟ ΚΑΤΑΣΚΕΥΗΣ: **ΠΛΑΣΤΙΚΟ ΜΕ ΨΥΚΤΡΑ ΑΛΟΥΜΙΝΙΟΥ**

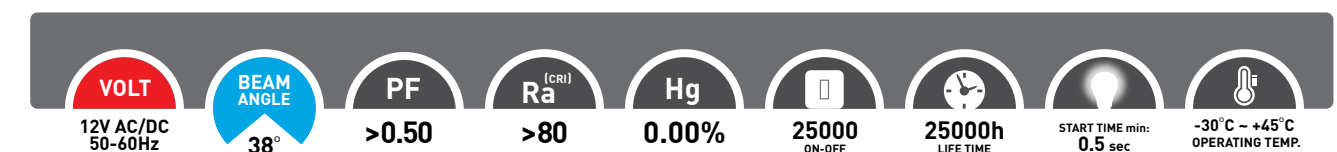

| BARCODE       | CODE      | BASE  | TYPE | WATT =WATT | KELVIN | LUMEN | mm    | PACKING  | PRICE (€) |
|---------------|-----------|-------|------|------------|--------|-------|-------|----------|-----------|
| 5207227026249 | 147-84255 | GU5.3 | MR16 | 6W 55W     | 6500K  | 480   | 48 50 | 1/10/100 | 3.90      |
| 5207227026270 | 147-84256 | GU5.3 | MR16 | 6W 55W     | 4000K  | 480   | 48 50 | 1/10/100 | 3.90      |
| 5207227026300 | 147-84257 | GU5.3 | MR16 | 6W 55W     | 2700K  | 480   | 48 50 | 1/10/100 | 3.90      |

LED SMD BULBS • ΛΑΜΠΤΗΡΕΣ LED SMD  
GU10 • 38°

PRODUCTION MATERIAL: **PLASTIC WITH ALUMINIUM HEATSINK**  
ΥΛΙΚΟ ΚΑΤΑΣΚΕΥΗΣ: **ΠΛΑΣΤΙΚΟ ΜΕ ΨΥΚΤΡΑ ΑΛΟΥΜΙΝΙΟΥ**



VOLT 220-240V 50-60Hz | BEAM ANGLE 38° | PF >0.50 | Ra (CRI) >80 | Hg 0.00% | 25000 ON-OFF | 25000h LIFE TIME | START TIME min: 0.5 sec | -30°C ~ +45°C OPERATING TEMP.

| BARCODE       | CODE      | BASE | TYPE | WATT | =WATT | KELVIN | LUMEN | mm    | PACKING  | PRICE (€) |
|---------------|-----------|------|------|------|-------|--------|-------|-------|----------|-----------|
| 5206139038555 | 147-84210 | GU10 | GU10 | 4W   | 36W   | 6500K  | 330   | 56 50 | 1/10/100 | 3.25      |
| 5206139068903 | 147-84211 | GU10 | GU10 | 4W   | 36W   | 4000K  | 330   | 56 50 | 1/10/100 | 3.25      |
| 5206139038258 | 147-84212 | GU10 | GU10 | 4W   | 36W   | 2700K  | 330   | 56 50 | 1/10/100 | 3.25      |
| 5206139070944 | 147-84265 | GU10 | GU10 | 6W   | 55W   | 6500K  | 525   | 56 50 | 1/10/100 | 3.70      |
| 5206139070975 | 147-84266 | GU10 | GU10 | 6W   | 55W   | 4000K  | 525   | 56 50 | 1/10/100 | 3.70      |
| 5206139071002 | 147-84267 | GU10 | GU10 | 6W   | 55W   | 2700K  | 525   | 56 50 | 1/10/100 | 3.70      |

LED SMD BULBS • ΛΑΜΠΤΗΡΕΣ LED SMD  
GU10 • 110°

PRODUCTION MATERIAL: **PLASTIC WITH ALUMINIUM HEATSINK**  
ΥΛΙΚΟ ΚΑΤΑΣΚΕΥΗΣ: **ΠΛΑΣΤΙΚΟ ΜΕ ΨΥΚΤΡΑ ΑΛΟΥΜΙΝΙΟΥ**

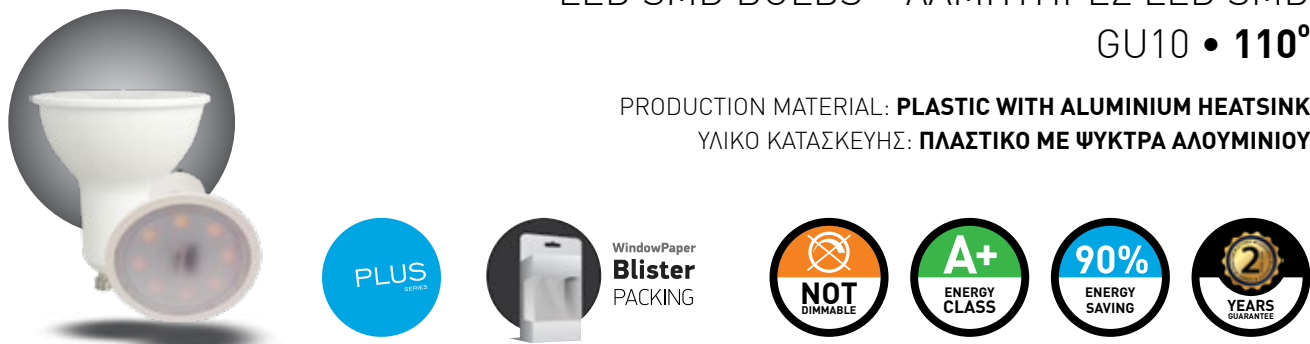

VOLT 220-240V 50-60Hz | BEAM ANGLE 110° | PF >0.50 | Ra (CRI) >80 | Hg 0.00% | 25000 ON-OFF | 25000h LIFE TIME | START TIME min: 0.5 sec | -30°C ~ +45°C OPERATING TEMP.

| BARCODE       | CODE      | BASE | TYPE | WATT | =WATT | KELVIN | LUMEN | mm    | PACKING  | PRICE (€) |
|---------------|-----------|------|------|------|-------|--------|-------|-------|----------|-----------|
| 5206139071033 | 147-84220 | GU10 | GU10 | 4W   | 36W   | 6500K  | 380   | 56 50 | 1/10/100 | 2.55      |
| 5206139071064 | 147-84221 | GU10 | GU10 | 4W   | 36W   | 4000K  | 380   | 56 50 | 1/10/100 | 2.55      |
| 5206139068248 | 147-84222 | GU10 | GU10 | 4W   | 36W   | 2700K  | 380   | 56 50 | 1/10/100 | 2.55      |
| 5206139071095 | 147-84270 | GU10 | GU10 | 6W   | 55W   | 6500K  | 530   | 56 50 | 1/10/100 | 2.90      |
| 5206139071125 | 147-84271 | GU10 | GU10 | 6W   | 55W   | 4000K  | 530   | 56 50 | 1/10/100 | 2.90      |
| 5206139068934 | 147-84272 | GU10 | GU10 | 6W   | 55W   | 2700K  | 530   | 56 50 | 1/10/100 | 2.90      |

LED SMD BULBS • ΛΑΜΠΤΗΡΕΣ LED SMD • GU10 - GU10 • COLOR • 38°

PRODUCTION MATERIAL: **PLASTIC WITH ALUMINIUM HEATSINK**  
ΥΛΙΚΟ ΚΑΤΑΣΚΕΥΗΣ: **ΠΛΑΣΤΙΚΟ ΜΕ ΨΥΚΤΡΑ ΑΛΟΥΜΙΝΙΟΥ**



VOLT 220-240V 50-60Hz | BEAM ANGLE 38° | PF >0.50 | Ra (CRI) >80 | Hg 0.00% | 25000 ON-OFF | 25000h LIFE TIME | START TIME min: 0.5 sec | -30°C ~ +45°C OPERATING TEMP.

| BARCODE       | CODE      | BASE | TYPE | WATT | LIGHT COLOR | mm    | PACKING  | PRICE (€) |
|---------------|-----------|------|------|------|-------------|-------|----------|-----------|
| 5206139008350 | 147-84215 | GU10 | GU10 | 4W   | RED         | 56 50 | 1/10/100 | 6.30      |
| 5206139008367 | 147-84216 | GU10 | GU10 | 4W   | GREEN       | 56 50 | 1/10/100 | 6.30      |
| 5206139008374 | 147-84217 | GU10 | GU10 | 4W   | BLUE        | 56 50 | 1/10/100 | 6.30      |
| 5206139008381 | 147-84218 | GU10 | GU10 | 4W   | YELLOW      | 56 50 | 1/10/100 | 6.30      |

LED SMD BULBS • ΛΑΜΠΤΗΡΕΣ LED SMD  
• GU10 • DIMMABLE

PRODUCTION MATERIAL: **PLASTIC WITH ALUMINIUM HEATSINK**  
ΥΛΙΚΟ ΚΑΤΑΣΚΕΥΗΣ: **ΠΛΑΣΤΙΚΟ ΜΕ ΨΥΚΤΡΑ ΑΛΟΥΜΙΝΙΟΥ**



VOLT 220-240V 50-60Hz | BEAM ANGLE 38° | PF >0.65 | Ra (CRI) >80 | Hg 0.00% | 25000 ON-OFF | 25000h LIFE TIME | START TIME min: 0.5 sec | -30°C ~ +45°C OPERATING TEMP.

| BARCODE       | CODE      | BASE | TYPE | WATT | =WATT | KELVIN | LUMEN | mm    | PACKING  | PRICE (€) |
|---------------|-----------|------|------|------|-------|--------|-------|-------|----------|-----------|
| 5207227072024 | 147-77874 | GU10 | GU10 | 6.5W | 50W   | 6500K  | 630   | 56 50 | 1/10/100 | 5.80      |
| 5207227072055 | 147-77875 | GU10 | GU10 | 6.5W | 50W   | 4000K  | 630   | 56 50 | 1/10/100 | 5.80      |
| 5207227072086 | 147-77876 | GU10 | GU10 | 6.5W | 50W   | 3000K  | 630   | 56 50 | 1/10/100 | 5.80      |
| 5207227072116 | 147-77877 | GU10 | GU10 | 6.5W | 50W   | 2700K  | 630   | 56 50 | 1/10/100 | 5.80      |



| BARCODE       | CODE      | BASE | TYPE | WATT | =WATT | KELVIN | LUMEN | mm    | PACKING  | PRICE (€) |
|---------------|-----------|------|------|------|-------|--------|-------|-------|----------|-----------|
| 5207227076695 | 147-77870 | GU10 | GU10 | 6.5W | 50W   | 6500K  | 630   | 56 50 | 1/10/100 | 5.80      |
| 5207227076725 | 147-77871 | GU10 | GU10 | 6.5W | 50W   | 4000K  | 630   | 56 50 | 1/10/100 | 5.80      |
| 5207227076756 | 147-77872 | GU10 | GU10 | 6.5W | 50W   | 3000K  | 630   | 56 50 | 1/10/100 | 5.80      |
| 5207227076787 | 147-77873 | GU10 | GU10 | 6.5W | 50W   | 2700K  | 630   | 56 50 | 1/10/100 | 5.80      |



## LED SMD BULBS • ΛΑΜΠΤΗΡΕΣ LED SMD • GU10 • 38°

PRODUCTION MATERIAL: **PLASTIC WITH ALUMINIUM HEATSINK**  
 ΥΛΙΚΟ ΚΑΤΑΣΚΕΥΗΣ: **ΠΛΑΣΤΙΚΟ ΜΕ ΨΥΚΤΡΑ ΑΛΟΥΜΙΝΙΟΥ**

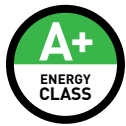

|                             |                   |             |                 |             |                 |                     |                            |                                  |
|-----------------------------|-------------------|-------------|-----------------|-------------|-----------------|---------------------|----------------------------|----------------------------------|
| VOLT<br>220-240V<br>50-60Hz | BEAM ANGLE<br>38° | PF<br>>0.50 | Ra (CRI)<br>>80 | Hg<br>0.00% | ON-OFF<br>15000 | LIFE TIME<br>15000h | START TIME min:<br>0.5 sec | OPERATING TEMP.<br>-30°C ~ +45°C |
|-----------------------------|-------------------|-------------|-----------------|-------------|-----------------|---------------------|----------------------------|----------------------------------|

| BARCODE       | CODE      | BASE | TYPE | WATT | =WATT | KELVIN | LUMEN | mm    | PACKING  | PRICE (€) |
|---------------|-----------|------|------|------|-------|--------|-------|-------|----------|-----------|
| 5207227037139 | 180-80810 | GU10 | GU10 | 5W   | 45W   | 6500K  | 450   | 56 50 | 1/10/100 | 2.10      |
| 5207227037146 | 180-80811 | GU10 | GU10 | 5W   | 45W   | 4000K  | 450   | 56 50 | 1/10/100 | 2.10      |
| 5207227037153 | 180-80813 | GU10 | GU10 | 5W   | 45W   | 3000K  | 450   | 56 50 | 1/10/100 | 2.10      |
| 5207227037191 | 180-80830 | GU10 | GU10 | 7W   | 55W   | 6500K  | 560   | 56 50 | 1/10/100 | 2.30      |
| 5207227037207 | 180-80831 | GU10 | GU10 | 7W   | 55W   | 4000K  | 560   | 56 50 | 1/10/100 | 2.30      |
| 5207227037214 | 180-80833 | GU10 | GU10 | 7W   | 55W   | 3000K  | 560   | 56 50 | 1/10/100 | 2.30      |



## LED SMD BULBS • ΛΑΜΠΤΗΡΕΣ LED SMD GU10 • 105°

PRODUCTION MATERIAL: **PLASTIC WITH ALUMINIUM HEATSINK**  
 ΥΛΙΚΟ ΚΑΤΑΣΚΕΥΗΣ: **ΠΛΑΣΤΙΚΟ ΜΕ ΨΥΚΤΡΑ ΑΛΟΥΜΙΝΙΟΥ**



|                             |                    |             |                 |             |                 |                     |                            |                                  |
|-----------------------------|--------------------|-------------|-----------------|-------------|-----------------|---------------------|----------------------------|----------------------------------|
| VOLT<br>220-240V<br>50-60Hz | BEAM ANGLE<br>105° | PF<br>>0.50 | Ra (CRI)<br>>80 | Hg<br>0.00% | ON-OFF<br>15000 | LIFE TIME<br>15000h | START TIME min:<br>0.5 sec | OPERATING TEMP.<br>-30°C ~ +45°C |
|-----------------------------|--------------------|-------------|-----------------|-------------|-----------------|---------------------|----------------------------|----------------------------------|

| BARCODE       | CODE      | BASE | TYPE | WATT | =WATT | KELVIN | LUMEN | mm    | PACKING  | PRICE (€) |
|---------------|-----------|------|------|------|-------|--------|-------|-------|----------|-----------|
| 5207227037160 | 180-80814 | GU10 | GU10 | 5W   | 45W   | 6500K  | 450   | 56 50 | 1/10/100 | 2.10      |
| 5207227037177 | 180-80815 | GU10 | GU10 | 5W   | 45W   | 4000K  | 450   | 56 50 | 1/10/100 | 2.10      |
| 5207227037184 | 180-80817 | GU10 | GU10 | 5W   | 45W   | 3000K  | 450   | 56 50 | 1/10/100 | 2.10      |
| 5207227037221 | 180-80834 | GU10 | GU10 | 7W   | 55W   | 6500K  | 560   | 56 50 | 1/10/100 | 2.30      |
| 5207227037238 | 180-80835 | GU10 | GU10 | 7W   | 55W   | 4000K  | 560   | 56 50 | 1/10/100 | 2.30      |
| 5207227037245 | 180-80837 | GU10 | GU10 | 7W   | 55W   | 3000K  | 560   | 56 50 | 1/10/100 | 2.30      |



TYPE: PAR 38 / BASE: E27

TYPE: PAR 30 / BASE: E27

TYPE: ES111 / BASE: GU10

TYPE: AR111 / BASE: GU5.3

TYPE: PAR 56



Types: AR111 / ES111 / PAR 30 - 38 - 56

**LED**

SMD Common Bulbs

Discover our Collection ►

LED SMD BULBS • ΛΑΜΠΤΗΡΕΣ LED SMD  
12V AC/DC • AR111 - G53

PRODUCTION MATERIAL: ALUMINIUM + PLASTIC WITH ALUMINIUM HEATSINK  
ΥΛΙΚΟ ΚΑΤΑΣΚΕΥΗΣ: ΑΛΟΥΜΙΝΙΟ + ΠΛΑΣΤΙΚΟ ΜΕ ΨΥΚΤΡΑ ΑΛΟΥΜΙΝΙΟΥ

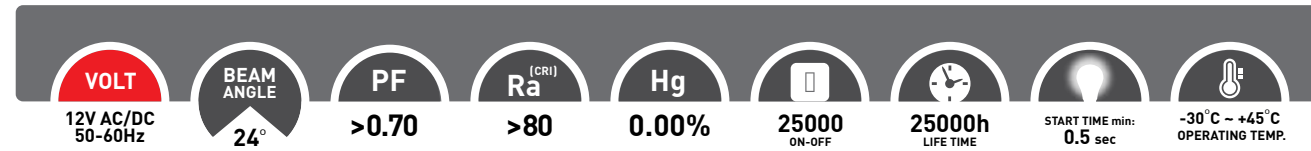

| BARCODE       | CODE      | BASE | TYPE  | WATT =WATT | KELVIN | LUMEN | mm     | PACKING | PRICE (€) |
|---------------|-----------|------|-------|------------|--------|-------|--------|---------|-----------|
| 5207227005374 | 147-84501 | G53  | AR111 | 11.5W 170W | 2700K  | 1200  | 60 111 | 1/10/20 | 14.30     |
| 5207227072987 | 147-77681 | G53  | AR111 | 12W 150W   | 4000K  | 1050  | 71 111 | 1/10/50 | 12.50     |

LED SMD BULBS • ΛΑΜΠΤΗΡΕΣ LED SMD  
AR111 / ES111 - GU10

PRODUCTION MATERIAL: ALUMINIUM + PLASTIC WITH ALUMINIUM HEATSINK  
ΥΛΙΚΟ ΚΑΤΑΣΚΕΥΗΣ: ΑΛΟΥΜΙΝΙΟ + ΠΛΑΣΤΙΚΟ ΜΕ ΨΥΚΤΡΑ ΑΛΟΥΜΙΝΙΟΥ

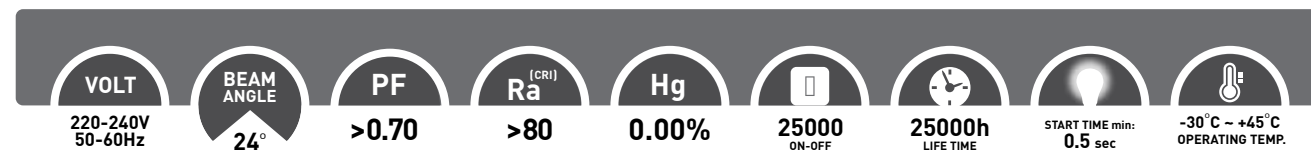

| BARCODE       | CODE      | BASE | TYPE  | WATT =WATT | KELVIN | LUMEN | mm     | PACKING | PRICE (€) |
|---------------|-----------|------|-------|------------|--------|-------|--------|---------|-----------|
| 5207227005343 | 147-84502 | GU10 | ES111 | 11.5W 170W | 2700K  | 1200  | 65 111 | 1/10/20 | 12.30     |
| 5207227072994 | 147-77684 | GU10 | AR111 | 12W 150W   | 4000K  | 1050  | 71 111 | 1/10/50 | 9.60      |

LED SMD BULBS • ΛΑΜΠΤΗΡΕΣ LED SMD  
12V AC/DC • DIMMABLE • AR111 - G53

PRODUCTION MATERIAL: ALUMINIUM + PLASTIC WITH ALUMINIUM HEATSINK  
ΥΛΙΚΟ ΚΑΤΑΣΚΕΥΗΣ: ΑΛΟΥΜΙΝΙΟ + ΠΛΑΣΤΙΚΟ ΜΕ ΨΥΚΤΡΑ ΑΛΟΥΜΙΝΙΟΥ

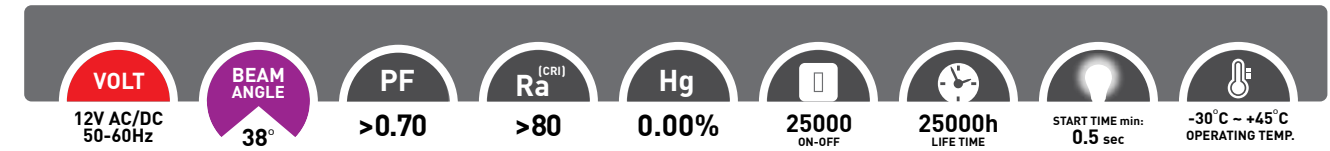

| BARCODE       | CODE      | BASE | TYPE  | WATT =WATT | KELVIN | LUMEN | mm     | PACKING | PRICE (€) |
|---------------|-----------|------|-------|------------|--------|-------|--------|---------|-----------|
| 5207227005237 | 147-84513 | G53  | AR111 | 11.5W 120W | 3000K  | 820   | 58 111 | 1/10/20 | 23.40     |



|               |           |     |       |            |       |     |        |         |       |
|---------------|-----------|-----|-------|------------|-------|-----|--------|---------|-------|
| 5207227005268 | 147-84514 | G53 | AR111 | 11.5W 120W | 2700K | 820 | 58 111 | 1/10/20 | 23.40 |
| 5207227005299 | 147-84515 | G53 | AR111 | 11.5W 120W | 3000K | 820 | 58 111 | 1/10/20 | 23.40 |

LED SMD BULBS • ΛΑΜΠΤΗΡΕΣ LED SMD  
DIMMABLE • ES111 - GU10

PRODUCTION MATERIAL: ALUMINIUM + PLASTIC WITH ALUMINIUM HEATSINK  
ΥΛΙΚΟ ΚΑΤΑΣΚΕΥΗΣ: ΑΛΟΥΜΙΝΙΟ + ΠΛΑΣΤΙΚΟ ΜΕ ΨΥΚΤΡΑ ΑΛΟΥΜΙΝΙΟΥ

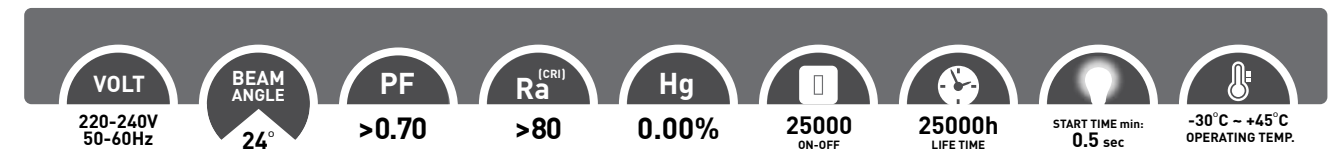

| BARCODE       | CODE      | BASE | TYPE  | WATT =WATT | KELVIN | LUMEN | mm     | PACKING | PRICE (€) |
|---------------|-----------|------|-------|------------|--------|-------|--------|---------|-----------|
| 5207227005206 | 147-84512 | GU10 | ES111 | 13.5W 170W | 2700K  | 1200  | 58 111 | 1/10/20 | 17.95     |



LED SMD BULBS • ΛΑΜΠΤΗΡΕΣ LED SMD  
PAR 30 - E27 • DIMMABLE

PRODUCTION MATERIAL: ALUMINIUM + PLASTIC WITH ALUMINIUM HEATSINK  
ΥΛΙΚΟ ΚΑΤΑΣΚΕΥΗΣ: ΑΛΟΥΜΙΝΙΟ + ΠΛΑΣΤΙΚΟ ΜΕ ΨΥΚΤΡΑ ΑΛΟΥΜΙΝΙΟΥ

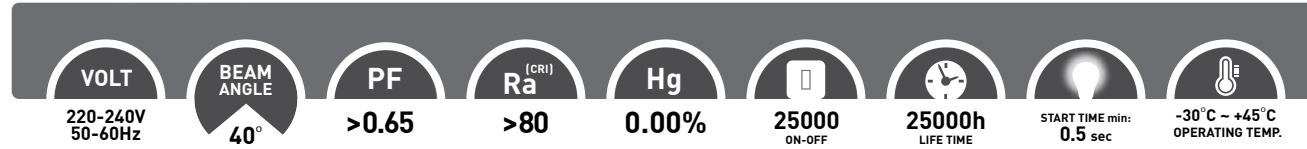

| BARCODE       | CODE      | BASE | TYPE   | WATT | =WATT | KELVIN | LUMEN | mm | mm  | PACKING | PRICE (€) |
|---------------|-----------|------|--------|------|-------|--------|-------|----|-----|---------|-----------|
| 5207227074585 | 147-77551 | E27  | PAR 30 | 15W  | 125W  | 4000K  | 1300  | 95 | 112 | 1/10/50 | 16.30     |
| 5207227074615 | 147-77552 | E27  | PAR 30 | 15W  | 125W  | 2700K  | 1300  | 95 | 112 | 1/10/50 | 16.30     |

LED SMD BULBS • ΛΑΜΠΤΗΡΕΣ LED SMD  
PAR 38 - E27

PRODUCTION MATERIAL: GLASS WITH ALUMINIUM BASE  
ΥΛΙΚΟ ΚΑΤΑΣΚΕΥΗΣ: ΓΥΑΛΙ ΜΕ ΒΑΣΗ ΑΛΟΥΜΙΝΙΟΥ

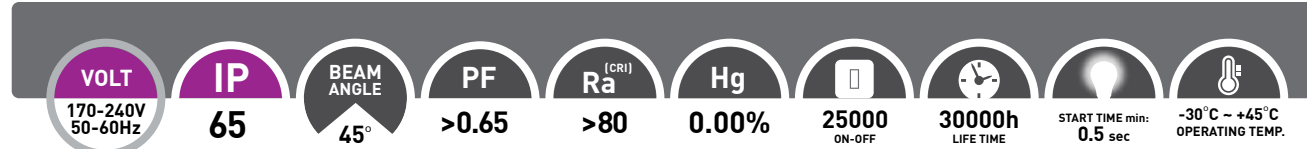
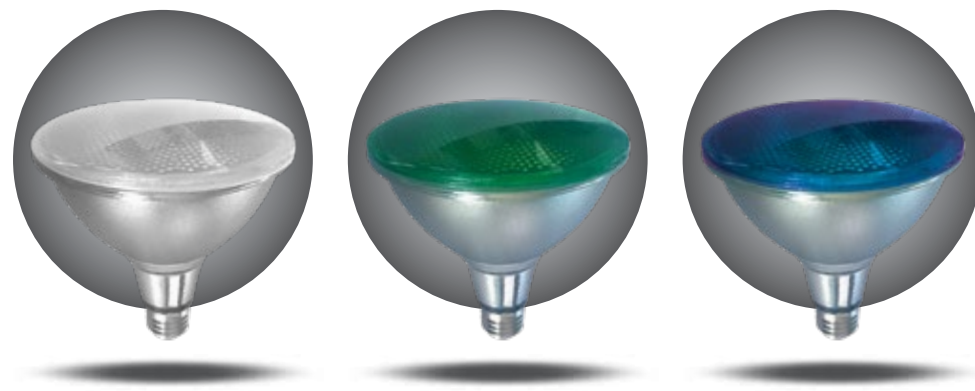

| BARCODE       | CODE      | BASE | TYPE   | WATT | =WATT | KELVIN | LUMEN | mm  | mm  | PACKING | PRICE (€) |
|---------------|-----------|------|--------|------|-------|--------|-------|-----|-----|---------|-----------|
| 5207227008313 | 147-84550 | E27  | PAR 38 | 15W  | 120W  | 6500K  | 1320  | 133 | 122 | 1/12    | 17.50     |
| 5207227008337 | 147-84551 | E27  | PAR 38 | 15W  | 120W  | 4000K  | 1320  | 133 | 122 | 1/12    | 17.50     |
| 5207227032011 | 147-84557 | E27  | PAR 38 | 15W  | 120W  | 3000K  | 1320  | 133 | 122 | 1/12    | 17.50     |
| 5207227008351 | 147-84553 | E27  | PAR 38 | 15W  | ----- | GREEN  | ----- | 133 | 122 | 1/12    | 17.50     |
| 5207227031991 | 147-84554 | E27  | PAR 38 | 15W  | ----- | BLUE   | ----- | 133 | 122 | 1/12    | 17.50     |



|               |           |     |        |     |       |       |       |     |     |      |       |
|---------------|-----------|-----|--------|-----|-------|-------|-------|-----|-----|------|-------|
| 5207227032035 | 147-84558 | E27 | PAR 38 | 15W | 120W  | 4000K | 1320  | 133 | 122 | 1/12 | 21.60 |
| 5207227032059 | 147-84559 | E27 | PAR 38 | 15W | ----- | GREEN | ----- | 133 | 122 | 1/12 | 21.60 |



LED SMD BULBS FOR POOL LIGHTS  
ΛΑΜΠΤΗΡΕΣ LED SMD ΓΙΑ ΦΩΤΙΣΤΙΚΑ ΠΙΣΙΝΑΣ  
PAR 56

PRODUCTION MATERIAL: GLASS WITH ALUMINIUM BASE  
ΥΛΙΚΟ ΚΑΤΑΣΚΕΥΗΣ: ΓΥΑΛΙ ΜΕ ΒΑΣΗ ΑΛΟΥΜΙΝΙΟΥ

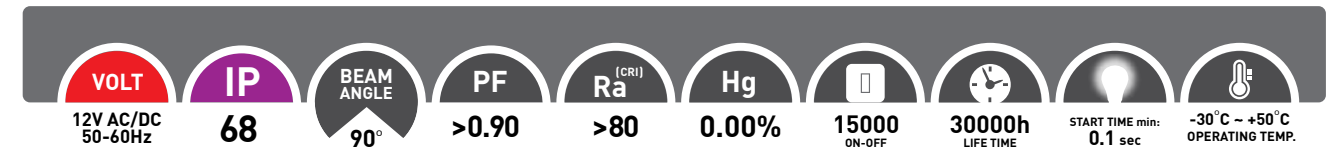

| BARCODE       | CODE      | TYPE   | WATT | =WATT | KELVIN | LUMEN | mm  | mm  | PACKING | PRICE (€) |
|---------------|-----------|--------|------|-------|--------|-------|-----|-----|---------|-----------|
| 5206139042439 | 147-84570 | PAR 56 | 20W  | 200W  | 6500K  | 1900  | 114 | 178 | 1/12    | 110.00    |
| 5207227059667 | 147-84571 | PAR 56 | 20W  | 200W  | 3000K  | 1700  | 114 | 178 | 1/12    | 110.00    |
| 5206139042453 | 147-84572 | PAR 56 | 20W  | ----- | BLUE   | ----- | 114 | 178 | 1/12    | 110.00    |
| 5206139042477 | 147-84573 | PAR 56 | 20W  | ----- | RGB    | ----- | 114 | 178 | 1/12    | 210.00    |

CONTROLLER ΚΑΙ ΔΙΑΚΟΠΤΗΣ ΓΙΑ PAR 56  
CONTROLLER AND SWITCH FOR PAR 56

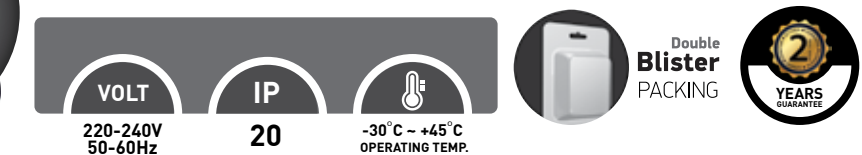

| BARCODE       | CODE      | WATT | PACKING | PRICE (€) |
|---------------|-----------|------|---------|-----------|
| 5206139042491 | 147-84575 | 120W | 1/50    | 43.80     |

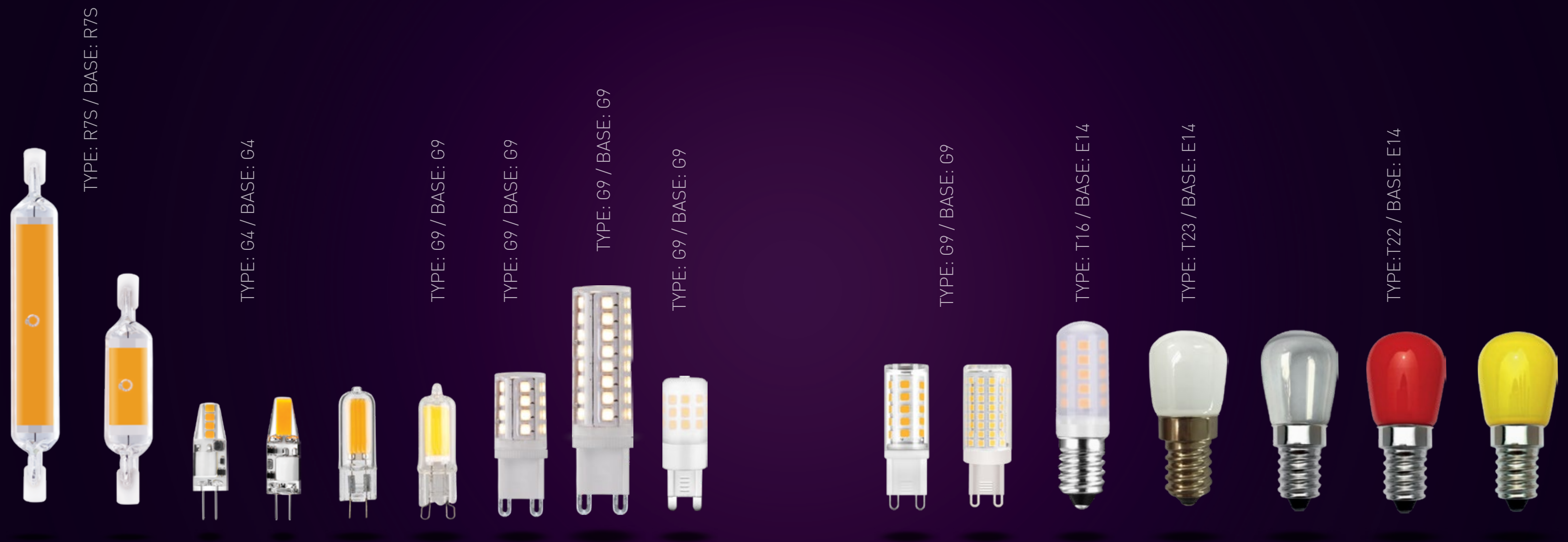

Types: R7S / G4 / G9 / T18 / T22 / T23

# LED SMD Common Bulbs

Discover our Collection ▶

LED COG BULBS • ΛΑΜΠΤΗΡΕΣ LED COG • R7S

PRODUCTION MATERIAL: **GLASS + CERAMIC BASE**  
ΥΛΙΚΟ ΚΑΤΑΣΚΕΥΗΣ: **ΓΥΑΛΙ ΜΕ ΚΕΡΑΜΙΚΗ ΒΑΣΗ**

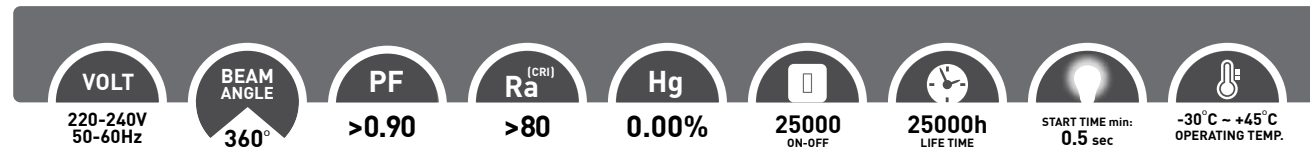
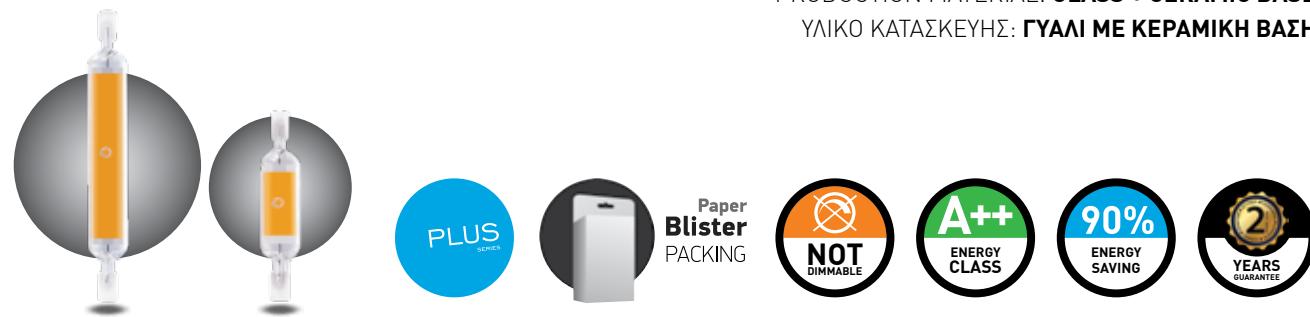

| BARCODE       | CODE      | BASE | TYPE | WATT =WATT | KELVIN | LUMEN | mm  | mm | PACKING  | PRICE (€) |
|---------------|-----------|------|------|------------|--------|-------|-----|----|----------|-----------|
| 5207227064111 | 147-77693 | R7S  | R7S  | 6W 70W     | 4000K  | 630   | 78  | 16 | 1/10/200 | 11.80     |
| 5207227064128 | 147-77694 | R7S  | R7S  | 6W 70W     | 3000K  | 630   | 78  | 16 | 1/10/200 | 11.80     |
| 5207227064135 | 147-77698 | R7S  | R7S  | 12W 100W   | 4000K  | 1260  | 118 | 16 | 1/10/200 | 14.10     |
| 5207227064142 | 147-77699 | R7S  | R7S  | 12W 100W   | 3000K  | 1260  | 118 | 16 | 1/10/200 | 14.10     |

LED COG BULBS • ΛΑΜΠΤΗΡΕΣ LED COB  
12V AC/DC • G4

PRODUCTION MATERIAL: **PCB + SILICONE**  
ΥΛΙΚΟ ΚΑΤΑΣΚΕΥΗΣ: **PCB + ΣΙΛΙΚΟΝΗ**

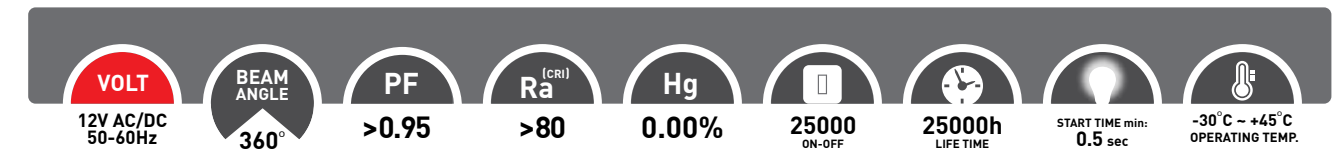

| BARCODE       | CODE      | BASE | TYPE | WATT =WATT | KELVIN | LUMEN | mm   | mm | PACKING     | PRICE (€) |
|---------------|-----------|------|------|------------|--------|-------|------|----|-------------|-----------|
| 5207227072888 | 147-77600 | G4   | G4   | 2W 28W     | 6500K  | 220   | 37.5 | 10 | 1/10/50/200 | 3.80      |
| 5207227072895 | 147-77601 | G4   | G4   | 2W 28W     | 4000K  | 220   | 37.5 | 10 | 1/10/50/200 | 3.80      |
| 5207227072901 | 147-77602 | G4   | G4   | 2W 28W     | 2700K  | 220   | 37.5 | 10 | 1/10/50/200 | 3.80      |
| 5207227036835 | 147-77603 | G4   | G4   | 3W 35W     | 6500K  | 300   | 41   | 12 | 1/10/50/200 | 5.10      |
| 5207227036842 | 147-77604 | G4   | G4   | 3W 35W     | 4000K  | 300   | 41   | 12 | 1/10/50/200 | 5.10      |
| 5207227064654 | 147-77605 | G4   | G4   | 3W 35W     | 2700K  | 300   | 41   | 12 | 1/10/50/200 | 5.10      |

LED COG BULBS • ΛΑΜΠΤΗΡΕΣ LED COG • G4

PRODUCTION MATERIAL: **GLASS**  
ΥΛΙΚΟ ΚΑΤΑΣΚΕΥΗΣ: **ΓΥΑΛΙ**

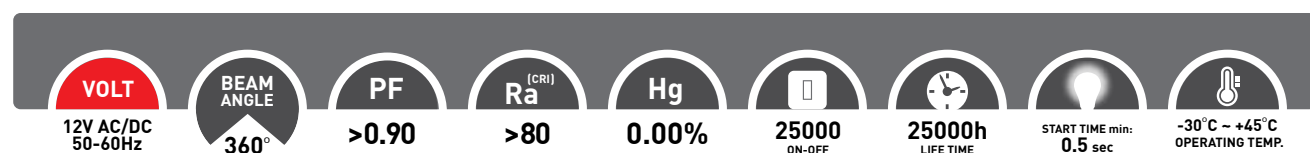

| BARCODE       | CODE      | BASE | TYPE | WATT =WATT | KELVIN | LUMEN | mm | mm   | PACKING     | PRICE (€) |
|---------------|-----------|------|------|------------|--------|-------|----|------|-------------|-----------|
| 5207227036859 | 147-84615 | G4   | G4   | 2W 30W     | 3000K  | 240   | 37 | 12.5 | 1/10/50/200 | 4.95      |
| 5207227036866 | 147-84616 | G4   | G4   | 2W 30W     | 4000K  | 240   | 37 | 12.5 | 1/10/50/200 | 4.95      |

LED BULBS • ΛΑΜΠΤΗΡΕΣ LED  
SILICONE • G4

PRODUCTION MATERIAL: **PCB + SILICONE**  
ΥΛΙΚΟ ΚΑΤΑΣΚΕΥΗΣ: **PCB + ΣΙΛΙΚΟΝΗ**

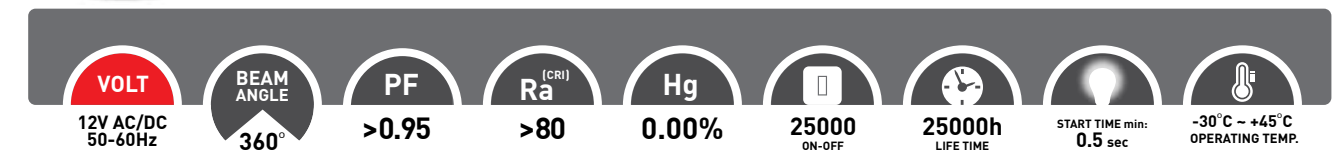

| BARCODE       | CODE      | BASE | TYPE | WATT =WATT | KELVIN | LUMEN | mm | mm | PACKING  | PRICE (€) |
|---------------|-----------|------|------|------------|--------|-------|----|----|----------|-----------|
| 5207227022203 | 147-84610 | G4   | G4   | 2W 25W     | 6500K  | 200   | 37 | 10 | 1/10/200 | 4.20      |
| 5207227022241 | 147-84611 | G4   | G4   | 2W 25W     | 2700K  | 200   | 37 | 10 | 1/10/200 | 4.20      |



### LED COG BULBS • ΛΑΜΠΤΗΡΕΣ LED COG • G9

PRODUCTION MATERIAL: **GLASS**  
ΥΛΙΚΟ ΚΑΤΑΣΚΕΥΗΣ: **ΓΥΑΛΙ**

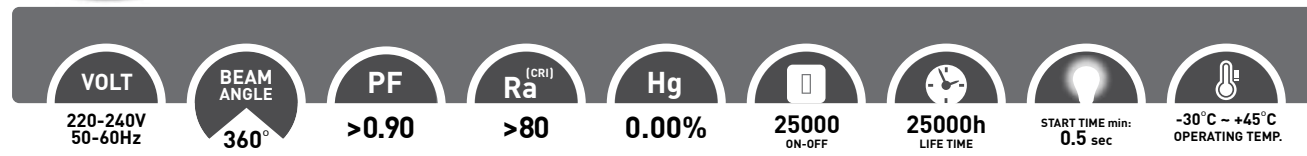

| BARCODE       | CODE      | BASE | TYPE | WATT | =WATT | KELVIN | LUMEN | mm   | mm | PACKING     | PRICE (€) |
|---------------|-----------|------|------|------|-------|--------|-------|------|----|-------------|-----------|
| 5207227037351 | 147-84634 | G9   | G9   | 3W   | 35W   | 6500K  | 300   | 46.7 | 12 | 1/10/50/200 | 3.45      |
| 5207227037368 | 147-84635 | G9   | G9   | 3W   | 35W   | 4000K  | 300   | 46.7 | 12 | 1/10/50/200 | 3.45      |
| 5207227037375 | 147-84636 | G9   | G9   | 3W   | 35W   | 3000K  | 300   | 46.7 | 12 | 1/10/50/200 | 3.45      |



### LED SMD BULBS • ΛΑΜΠΤΗΡΕΣ LED SMD • G9

PRODUCTION MATERIAL: **CERAMIC + PLASTIC**  
ΥΛΙΚΟ ΚΑΤΑΣΚΕΥΗΣ: **ΚΕΡΑΜΙΚΟ + ΠΛΑΣΤΙΚΟ**

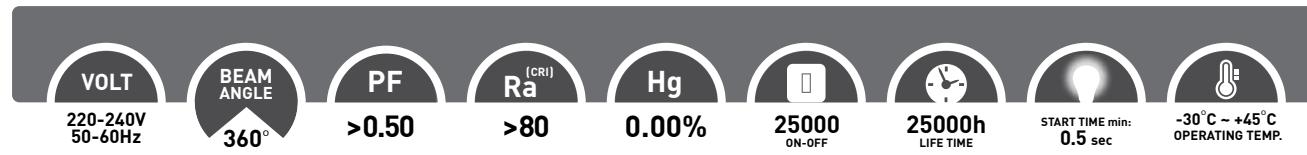

| BARCODE       | CODE      | BASE | TYPE | WATT | =WATT | KELVIN | LUMEN | mm | mm | PACKING     | PRICE (€) |
|---------------|-----------|------|------|------|-------|--------|-------|----|----|-------------|-----------|
| 5206139082169 | 147-84638 | G9   | G9   | 4W   | 40W   | 6500K  | 400   | 45 | 16 | 1/10/50/200 | 4.15      |
| 5207227073878 | 147-77625 | G9   | G9   | 4W   | 40W   | 4000K  | 400   | 45 | 16 | 1/10/50/200 | 4.15      |
| 5206139082176 | 147-84639 | G9   | G9   | 4W   | 40W   | 2700K  | 400   | 45 | 16 | 1/10/50/200 | 4.15      |



| BARCODE       | CODE      | BASE | TYPE | WATT | =WATT | KELVIN | LUMEN | mm | mm | PACKING     | PRICE (€) |
|---------------|-----------|------|------|------|-------|--------|-------|----|----|-------------|-----------|
| 5206139082183 | 147-84644 | G9   | G9   | 6W   | 50W   | 6500K  | 580   | 62 | 16 | 1/10/50/200 | 5.45      |
| 5207227076800 | 147-77628 | G9   | G9   | 6W   | 50W   | 4000K  | 580   | 62 | 16 | 1/10/50/200 | 5.45      |
| 5206139082190 | 147-84645 | G9   | G9   | 6W   | 50W   | 2700K  | 580   | 62 | 16 | 1/10/50/200 | 5.45      |

### LED SMD BULBS • ΛΑΜΠΤΗΡΕΣ LED SMD • G9

PRODUCTION MATERIAL: **CERAMIC + PLASTIC**  
ΥΛΙΚΟ ΚΑΤΑΣΚΕΥΗΣ: **ΚΕΡΑΜΙΚΟ + ΠΛΑΣΤΙΚΟ**

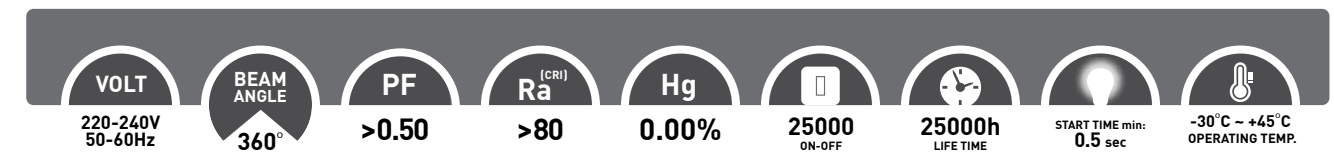

| BARCODE       | CODE      | BASE | TYPE | WATT | =WATT | KELVIN | LUMEN | mm | mm | PACKING     | PRICE (€) |
|---------------|-----------|------|------|------|-------|--------|-------|----|----|-------------|-----------|
| 5207227072949 | 147-77630 | G9   | G9   | 12W  | 85W   | 6500K  | 1200  | 64 | 23 | 1/10/50/200 | 8.70      |
| 5207227072956 | 147-77631 | G9   | G9   | 12W  | 85W   | 4000K  | 1200  | 64 | 23 | 1/10/50/200 | 8.70      |
| 5207227072963 | 147-77632 | G9   | G9   | 12W  | 85W   | 3000K  | 1200  | 64 | 23 | 1/10/50/200 | 8.70      |

### LED SMD BULBS • ΛΑΜΠΤΗΡΕΣ LED SMD / G9 • BLISTER

PRODUCTION MATERIAL: **CERAMIC + PLASTIC**  
ΥΛΙΚΟ ΚΑΤΑΣΚΕΥΗΣ: **ΚΕΡΑΜΙΚΟ + ΠΛΑΣΤΙΚΟ**

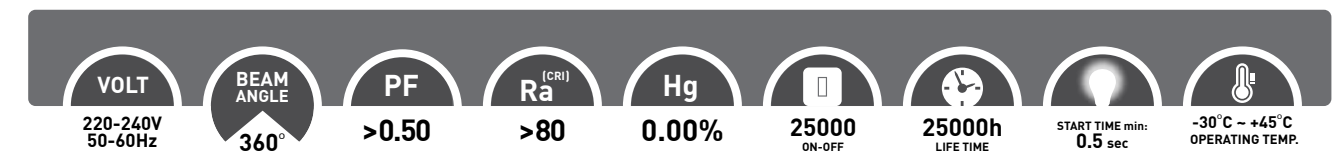

| BARCODE       | CODE      | BASE | TYPE | WATT | =WATT | KELVIN | LUMEN | mm | mm | PACKING  | PRICE (€) |
|---------------|-----------|------|------|------|-------|--------|-------|----|----|----------|-----------|
| 5207227029233 | 800-84654 | G9   | G9   | 6W   | 70W   | 4000K  | 580   | 62 | 16 | 1/10/100 | 11.55     |
| 5207227029264 | 800-84655 | G9   | G9   | 6W   | 70W   | 2700K  | 580   | 62 | 16 | 1/10/100 | 11.55     |



LED SMD BULBS • ΛΑΜΠΤΗΡΕΣ LED SMD • G9  
**3 STEPS DIMMABLE**

PRODUCTION MATERIAL: **CERAMIC + PLASTIC**  
ΥΛΙΚΟ ΚΑΤΑΣΚΕΥΗΣ: **ΚΕΡΑΜΙΚΟ + ΠΛΑΣΤΙΚΟ**

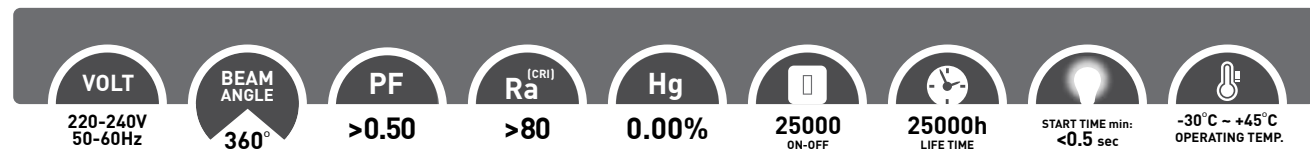
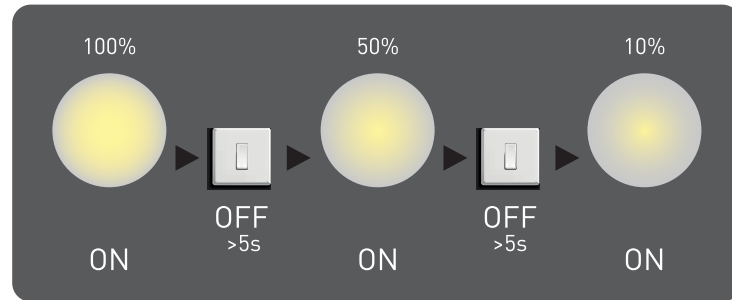

| BARCODE       | CODE      | BASE | TYPE | WATT | =WATT | KELVIN | LUMEN | mm | mm | PACKING     | PRICE (€) |
|---------------|-----------|------|------|------|-------|--------|-------|----|----|-------------|-----------|
| 5207227036958 | 147-84677 | G9   | G9   | 4W   | 40W   | 6500K  | 350   | 50 | 16 | 1/10/50/200 | 5.40      |
| 5207227036965 | 147-84678 | G9   | G9   | 4W   | 40W   | 4000K  | 350   | 50 | 16 | 1/10/50/200 | 5.40      |
| 5207227036972 | 147-84679 | G9   | G9   | 4W   | 40W   | 3000K  | 350   | 50 | 16 | 1/10/50/200 | 5.40      |

LED SMD BULBS • ΛΑΜΠΤΗΡΕΣ LED SMD • G9 • **DIMMABLE**



PRODUCTION MATERIAL: **CERAMIC + PLASTIC**  
ΥΛΙΚΟ ΚΑΤΑΣΚΕΥΗΣ: **ΚΕΡΑΜΙΚΟ + ΠΛΑΣΤΙΚΟ**

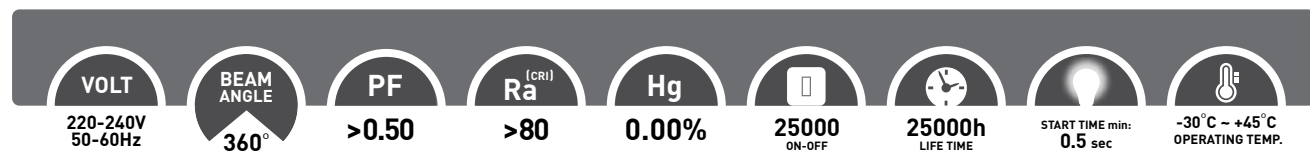

| BARCODE       | CODE      | BASE | TYPE | WATT | =WATT | KELVIN | LUMEN | mm | mm | PACKING     | PRICE (€) |
|---------------|-----------|------|------|------|-------|--------|-------|----|----|-------------|-----------|
| 5207227036927 | 147-84667 | G9   | G9   | 4W   | 50W   | 6500K  | 400   | 54 | 18 | 1/10/50/200 | 4.75      |
| 5207227036934 | 147-84668 | G9   | G9   | 4W   | 50W   | 4000K  | 400   | 54 | 18 | 1/10/50/200 | 4.75      |
| 5207227036941 | 147-84669 | G9   | G9   | 4W   | 50W   | 3000K  | 400   | 54 | 18 | 1/10/50/200 | 4.75      |



REFRIGERATOR LED LAMP • ΛΑΜΠΤΗΡΑΣ LED ΨΥΓΕΙΟΥ

PRODUCTION MATERIAL: **PLASTIC WITH ALUMINIUM HEATSINK**  
ΥΛΙΚΟ ΚΑΤΑΣΚΕΥΗΣ: **ΠΛΑΣΤΙΚΟ ΜΕ ΨΥΚΤΡΑ ΑΛΟΥΜΙΝΙΟΥ**

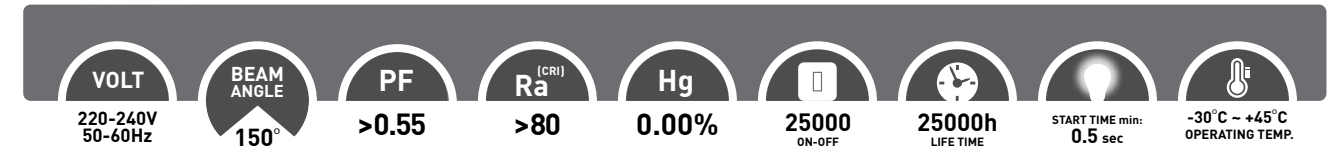

| BARCODE       | CODE      | BASE | TYPE | WATT | =WATT | KELVIN | LUMEN | mm | mm | PACKING  | PRICE (€) |
|---------------|-----------|------|------|------|-------|--------|-------|----|----|----------|-----------|
| 5206139076656 | 147-82800 | E14  | T23  | 1W   | 10W   | 2700K  | 70    | 50 | 23 | 1/10/200 | 3.75      |



| BARCODE       | CODE      | BASE | TYPE | WATT | =WATT | KELVIN | LUMEN | mm | mm | PACKING  | PRICE (€) |
|---------------|-----------|------|------|------|-------|--------|-------|----|----|----------|-----------|
| 5207227037337 | 147-82801 | E14  | T16  | 3W   | 30W   | 2700K  | 260   | 52 | 16 | 1/10/200 | 5.25      |

• NIGHT LED LAMP • ΛΑΜΠΤΗΡΑΣ LED ΝΥΚΤΟΣ

PRODUCTION MATERIAL: **PLASTIC WITH ALUMINIUM HEATSINK**  
ΥΛΙΚΟ ΚΑΤΑΣΚΕΥΗΣ: **ΠΛΑΣΤΙΚΟ ΜΕ ΨΥΚΤΡΑ ΑΛΟΥΜΙΝΙΟΥ**

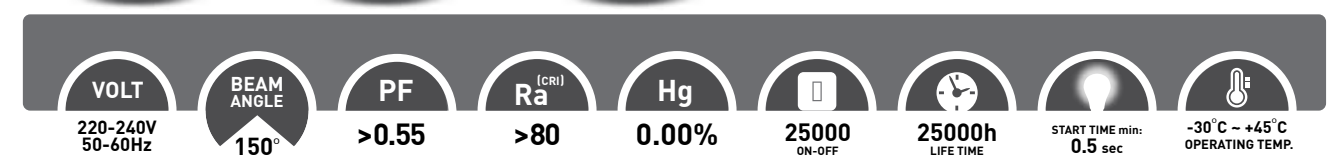
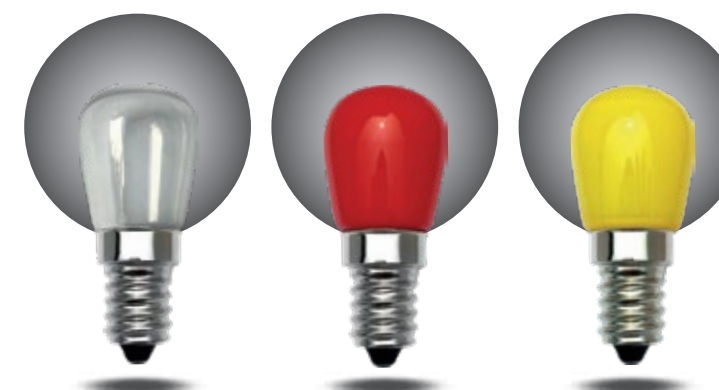

| BARCODE       | CODE      | BASE | TYPE | WATT | =WATT | KELVIN | LUMEN | mm | mm | PACKING  | PRICE (€) |
|---------------|-----------|------|------|------|-------|--------|-------|----|----|----------|-----------|
| 5207227014918 | 147-82820 | E14  | T22  | 1.5W | 10W   | 2700K  | 70    | 50 | 23 | 1/20/200 | 3.00      |
| 5207227015007 | 147-82822 | E14  | T22  | 1.5W | ----  | RED    | ----  | 50 | 23 | 1/20/200 | 3.00      |
| 5207227015090 | 147-82823 | E14  | T22  | 1.5W | ----  | YELLOW | ----  | 50 | 23 | 1/20/200 | 3.00      |



*Filament* | *Filament* DECO SERIES | GOLD GLASS | *Vintage Edison*

Types:  
C37 / A60 / ST64 / G95 / G125 / G200 / P165 / DIAMOND

Decorative Bulbs Series

Discover our Collection ►

• LED FILAMENT BULBS • ΛΑΜΠΤΗΡΕΣ LED FILAMENT  
**• DECO<sup>SERIES</sup> • GOLD GLASS • DIMMABLE**  
 ST64 / G95 / G125 - E27

PRODUCTION MATERIAL: **GLASS (GOLD COVER)**  
 ΥΛΙΚΟ ΚΑΤΑΣΚΕΥΗΣ: **ΓΥΑΛΙ (ΧΡΥΣΑΦΙ ΕΠΙΚΑΛΥΨΗ)**

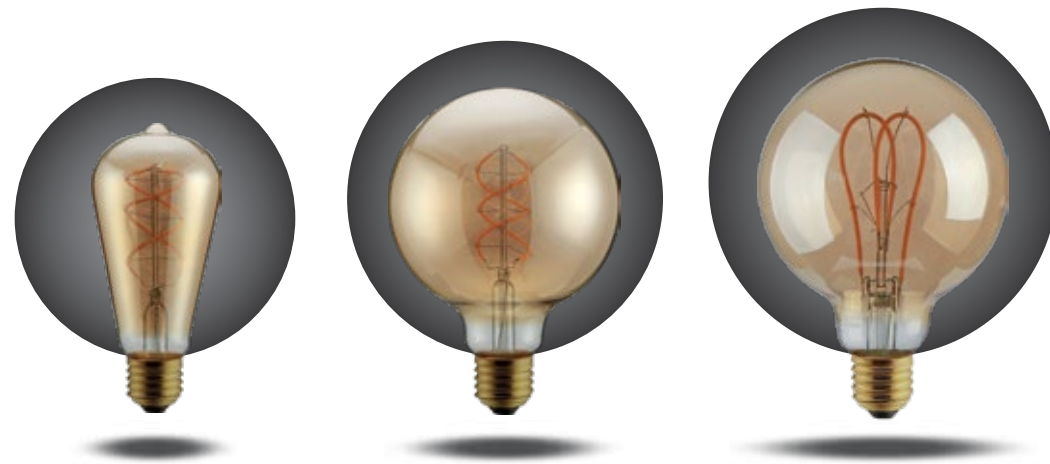

| VOLT                | BEAM ANGLE | PF    | CRI Ra | Hg    | ON-OFF | LIFE TIME | START TIME min: | OPERATING TEMP. |           |       |
|---------------------|------------|-------|--------|-------|--------|-----------|-----------------|-----------------|-----------|-------|
| 220-240V<br>50-60Hz | 360°       | >0.50 | >80    | 0.00% | 15000  | 25000h    | 0.5 sec         | -30°C ~ +45°C   |           |       |
| BARCODE             | CODE       | BASE  | TYPE   | WATT  | KELVIN | LUMEN     | mm              | PACKING         | PRICE (€) |       |
| 5207227017667       | 147-81804  | E27   | ST64   | 5W    | 2000K  | 300       | 140             | 64              | 1/10/50   | 9.00  |
| 5207227017728       | 147-81806  | E27   | G95    | 5W    | 2000K  | 300       | 142             | 95              | 1/5/20    | 10.70 |
| 5207227017759       | 147-81807  | E27   | G125   | 5W    | 2000K  | 300       | 170             | 125             | 1/5/20    | 12.25 |

• LED FILAMENT BULBS • ΛΑΜΠΤΗΡΕΣ LED FILAMENT  
**• DECORATIVE • GOLD GLASS<sup>SERIES</sup> • DIMMABLE**  
 G95 / G125 - E27

PRODUCTION MATERIAL: **GLASS (GOLD COVER)**  
 ΥΛΙΚΟ ΚΑΤΑΣΚΕΥΗΣ: **ΓΥΑΛΙ (ΧΡΥΣΑΦΙ ΕΠΙΚΑΛΥΨΗ)**



| VOLT                | BEAM ANGLE | PF    | CRI Ra | Hg    | ON-OFF | LIFE TIME | START TIME min: | OPERATING TEMP. |           |      |
|---------------------|------------|-------|--------|-------|--------|-----------|-----------------|-----------------|-----------|------|
| 220-240V<br>50-60Hz | 360°       | >0.90 | >90    | 0.00% | 25000  | 25000h    | 0.5 sec         | -30°C ~ +45°C   |           |      |
| BARCODE             | CODE       | BASE  | TYPE   | WATT  | KELVIN | LUMEN     | mm              | PACKING         | PRICE (€) |      |
| 5207227036743       | 147-81801  | E27   | A60    | 7W    | 2400K  | 806       | 106             | 60              | 1/10/50   | 5.60 |

• LED FILAMENT CROSSED BULBS • ΛΑΜΠΤΗΡΕΣ LED FILAMENT CROSSED  
**• DECORATIVE • GOLD GLASS • DIMMABLE**  
 C37 - E14

PRODUCTION MATERIAL: **GLASS (GOLD COVER)**  
 ΥΛΙΚΟ ΚΑΤΑΣΚΕΥΗΣ: **ΓΥΑΛΙ (ΧΡΥΣΑΦΙ ΕΠΙΚΑΛΥΨΗ)**



| VOLT                | BEAM ANGLE | PF    | CRI Ra | Hg    | ON-OFF | LIFE TIME | START TIME min: | OPERATING TEMP. |           |      |
|---------------------|------------|-------|--------|-------|--------|-----------|-----------------|-----------------|-----------|------|
| 220-240V<br>50-60Hz | 360°       | >0.90 | >90    | 0.00% | 25000  | 25000h    | 0.5 sec         | -30°C ~ +45°C   |           |      |
| BARCODE             | CODE       | BASE  | TYPE   | WATT  | KELVIN | LUMEN     | mm              | PACKING         | PRICE (€) |      |
| 5207227036750       | 147-81812  | E14   | C37    | 4.5W  | 2400K  | 480       | 98              | 35              | 1/10/50   | 4.45 |

• LED FILAMENT CROSSED BULBS • ΛΑΜΠΤΗΡΕΣ LED FILAMENT CROSSED  
**• DECORATIVE • GOLD GLASS<sup>SERIES</sup> • DIMMABLE**  
 G95 / G125 - E27

PRODUCTION MATERIAL: **GLASS (GOLD COVER)**  
 ΥΛΙΚΟ ΚΑΤΑΣΚΕΥΗΣ: **ΓΥΑΛΙ (ΧΡΥΣΑΦΙ ΕΠΙΚΑΛΥΨΗ)**



| VOLT                | BEAM ANGLE | PF    | CRI Ra | Hg    | ON-OFF | LIFE TIME | START TIME min: | OPERATING TEMP. |           |       |
|---------------------|------------|-------|--------|-------|--------|-----------|-----------------|-----------------|-----------|-------|
| 220-240V<br>50-60Hz | 360°       | >0.90 | >80    | 0.00% | 25000  | 25000h    | 0.5 sec         | -30°C ~ +45°C   |           |       |
| BARCODE             | CODE       | BASE  | TYPE   | WATT  | KELVIN | LUMEN     | mm              | PACKING         | PRICE (€) |       |
| 5207227007835       | 147-81471  | E27   | G95    | 8W    | 2400K  | 1055      | 138             | 95              | 1/5/20    | 9.85  |
| 5207227007866       | 147-81481  | E27   | G125   | 8W    | 2400K  | 1055      | 170             | 125             | 1/5/20    | 10.55 |

• LED FILAMENT BULBS • ΛΑΜΠΤΗΡΕΣ LED FILAMENT  
• DECORATIVE • GOLD GLASS • DIMMABLE

ST64 - E27

PRODUCTION MATERIAL: **GLASS (GOLD COVER)**  
ΥΛΙΚΟ ΚΑΤΑΣΚΕΥΗΣ: ΓΥΑΛΙ (ΧΡΥΣΑΦΙ ΕΠΙΚΑΛΥΨΗ)



Filament  
**GOLD  
GLASS**



|                     |            |       |          |       |        |           |                 |                 |
|---------------------|------------|-------|----------|-------|--------|-----------|-----------------|-----------------|
| VOLT                | BEAM ANGLE | PF    | Ra (CRI) | Hg    | ON-OFF | LIFE TIME | START TIME min: | OPERATING TEMP. |
| 220-240V<br>50-60Hz | 360°       | >0.90 | >80      | 0.00% | 25000  | 25000h    | 0.5 sec         | -30°C ~ +45°C   |

| BARCODE       | CODE      | BASE | TYPE | WATT | KELVIN | LUMEN | mm  | mm | PACKING | PRICE (€) |
|---------------|-----------|------|------|------|--------|-------|-----|----|---------|-----------|
| 5206139038982 | 147-80930 | E27  | ST64 | 10W  | 2500K  | 1050  | 140 | 64 | 1/10/50 | 9.50      |

• LED BULBS • ΛΑΜΠΤΗΡΕΣ LED  
• DECORATIVE • GOLD GLASS • DIMMABLE

G95 / G125 - E27

PRODUCTION MATERIAL: **GLASS + ACRYLIC**  
ΥΛΙΚΟ ΚΑΤΑΣΚΕΥΗΣ: ΓΥΑΛΙ + ΑΚΡΥΛΙΚΟ



147-81820



147-81823



147-81824

**GOLD  
GLASS**

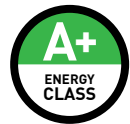

|                     |            |       |          |       |        |           |                 |                 |
|---------------------|------------|-------|----------|-------|--------|-----------|-----------------|-----------------|
| VOLT                | BEAM ANGLE | PF    | Ra (CRI) | Hg    | ON-OFF | LIFE TIME | START TIME min: | OPERATING TEMP. |
| 220-240V<br>50-60Hz | 360°       | >0.95 | >80      | 0.00% | 25000  | 25000h    | 0.5 sec         | -30°C ~ +45°C   |

| BARCODE       | CODE      | BASE | TYPE    | WATT | KELVIN | LUMEN | mm  | mm  | PACKING | PRICE (€) |
|---------------|-----------|------|---------|------|--------|-------|-----|-----|---------|-----------|
| 5207227036767 | 147-81820 | E27  | G95     | 3.5W | 2000K  | 120   | 145 | 95  | 1/20    | 22.00     |
| 5207227036774 | 147-81823 | E27  | G125    | 3.5W | 2000K  | 120   | 165 | 125 | 1/10    | 25.50     |
| 5207227056185 | 147-81824 | E27  | DIAMOND | 3.5W | 2000K  | 120   | 175 | 125 | 1/10    | 28.90     |

• LED BULBS • ΛΑΜΠΤΗΡΕΣ LED  
• DECORATIVE • GOLD GLASS • DIMMABLE

ST64 / G200 / P165 - E27

PRODUCTION MATERIAL: **GLASS + ACRYLIC**  
ΥΛΙΚΟ ΚΑΤΑΣΚΕΥΗΣ: ΓΥΑΛΙ + ΑΚΡΥΛΙΚΟ



147-81832



147-81830



147-81826

**GOLD  
GLASS**

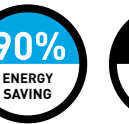

|                     |            |       |          |       |        |           |                 |                 |
|---------------------|------------|-------|----------|-------|--------|-----------|-----------------|-----------------|
| VOLT                | BEAM ANGLE | PF    | Ra (CRI) | Hg    | ON-OFF | LIFE TIME | START TIME min: | OPERATING TEMP. |
| 220-240V<br>50-60Hz | 360°       | >0.95 | >80      | 0.00% | 25000  | 25000h    | 0.5 sec         | -30°C ~ +45°C   |

| BARCODE       | CODE      | BASE | TYPE | WATT | KELVIN | LUMEN | mm  | mm  | PACKING | PRICE (€) |
|---------------|-----------|------|------|------|--------|-------|-----|-----|---------|-----------|
| 5207227036804 | 147-81832 | E27  | P165 | 3.5W | 2000K  | 120   | 303 | 165 | 1/4     | 50.95     |
| 5207227036798 | 147-81830 | E27  | G200 | 3.5W | 2000K  | 120   | 241 | 200 | 1/4     | 50.95     |
| 5207227036781 | 147-81826 | E27  | ST64 | 3.5W | 2000K  | 120   | 145 | 64  | 1/50    | 20.00     |

- EDISON BULBS • ΛΑΜΠΤΗΡΕΣ ΝΗΜΑΤΟΣ EDISON
- **DECORATIVE** • **DIMMABLE**
- G95 / G125 / ST64 - E27

PRODUCTION MATERIAL: **GLASS**  
ΥΛΙΚΟ ΚΑΤΑΣΚΕΥΗΣ: **ΓΥΑΛΙ**



147-88247



147-88246



147-88250

*Vintage Edison*



Paper  
**Blister**  
PACKING



|                                    |                           |                    |                       |                           |   |
|------------------------------------|---------------------------|--------------------|-----------------------|---------------------------|---|
| <b>VOLT</b><br>220-240V<br>50-60Hz | <b>BEAM ANGLE</b><br>360° | <b>Hg</b><br>0.00% | <b>1000</b><br>ON-OFF | <b>2000h</b><br>LIFE TIME | <b>-30°C ~ +45°C</b><br>OPERATING TEMP. |
|------------------------------------|---------------------------|--------------------|-----------------------|---------------------------|---|

| BARCODE       | CODE      | BASE | TYPE | WATT | LUMEN | mm  | mm  | PACKING  | PRICE (€) |
|---------------|-----------|------|------|------|-------|-----|-----|----------|-----------|
| 5206139097545 | 147-88247 | E27  | G125 | 40W  | 120   | 175 | 125 | 1/25     | 5.95      |
| 5206139077783 | 147-88246 | E27  | G95  | 25W  | 140   | 135 | 95  | 1/30     | 4.90      |
| 5206139068873 | 147-88250 | E27  | ST64 | 25W  | 140   | 140 | 64  | 1/10/100 | 3.40      |





TYPE: A60 WITH SOLAR PANELS / BASE: E27



TYPE: A60 WITH MOTION DETECTOR / BASE: E27



TYPE: A60 WITH DAY-NIGHT SENSOR / BASE: E27



TYPE: A60 - INSECT REPELLENT / BASE: E27



TYPE: A60 - BLACK LIGHT / BASE: E27



TYPE: A60 - SILVER MIRROR / BASE: E27



Type: A

**LED** SPECIAL TECHNOLOGIES Bulbs

Discover our Collection ▶

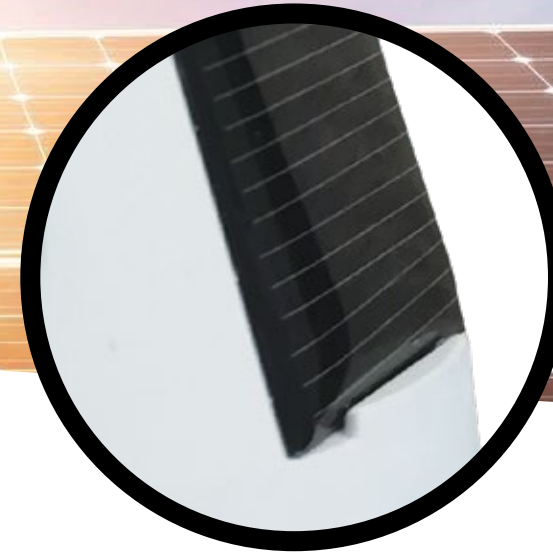

- LED SMD BULB WITH SOLAR PANEL
- ΛΑΜΠΤΗΡΑΣ LED SMD ΜΕ ΗΛΙΑΚΟ ΠΑΝΕΛ
- A70 - E27

PRODUCTION MATERIAL: **ABS + PLASTIC**  
ΥΛΙΚΟ ΚΑΤΑΣΚΕΥΗΣ: **ABS + ΠΛΑΣΤΙΚΟ**

- LED SMD BULB WITH BUILT-IN SOLAR PANELS
- ΛΑΜΠΤΗΡΑΣ LED SMD ΜΕ ΕΝΣΩΜΑΤΩΜΕΝΑ ΗΛΙΑΚΑ ΠΑΝΕΛ
- A70 - E27

PRODUCTION MATERIAL: **PP - PLASTIC**  
ΥΛΙΚΟ ΚΑΤΑΣΚΕΥΗΣ: **PP - ΠΛΑΣΤΙΚΟ**

#### ΕΙΔΙΚΕΣ ΕΦΑΡΜΟΓΕΣ:

- Φωτισμός Οικίας & Γραφείου
- Εφεδρικός Φωτισμός
- Φορητός Φωτισμός
- Φωτισμός με ηλιακή ενέργεια

#### ΕΙΔΙΚΕΣ ΛΕΙΤΟΥΡΓΙΕΣ:

- Αυτόματη μετάβαση σε λειτουργία με μπαταρία, όταν δεν υπάρχει ρεύμα, σαν λαμπτήρας εφεδρικού φωτισμού
- Φορητό και κατάλληλο για διάφορους χώρους
- Ενσωματωμένη μπαταρία Λιθίου 3.7V/2600mAh με αυτονομία λειτουργίας 60
- Εξοπλισμένο με είσοδο **USB Micro DC** για φόρτιση λαμπτήρων
- Κατ' επιλογήν **Φόρτιση με Ηλιακό Πάνελ**
- **Διεπαφή USB**, έξοδος 5V, 0.5A
- Μπορείτε να το συνδέσετε σε ένα κινητό τηλέφωνο για φόρτιση
- 3 τρόποι έναυσης ( Διακόπτης / Παρεχόμενος Γάντζος / Άγγιγμα ντου), με θύρα USB (Power Bank)
- Φόρτιση Μπαταρίας/ Αυτονομία Λειτουργίας: 4h/ 6h (Χρόνος φόρτισης με ισχύ A/C)

#### SPECIAL APPLICATIONS:

- Home & Office Lighting
- Emergency Lighting
- Portable Lighting
- Solar-Powered Lighting

#### SPECIAL FUNCTIONS:

- Automatically convert to powered by battery when no electricity, with emergency lighting function
- Portable & suitable for a variety of places
- Built-in 3.7V/2600mAh Lithium battery with 6Hrs working time
- Equipped with a **USB Micro DC** inlet for lamp charging
- **Charging with a solar** panel is optional
- **USB interface**, 5V, 0.5A output you can connect it to a cellphone for charging
- 3 ways to switch on (Switch/ Included Hook/ Touching Base), with USB Port (Power Bank)
- Battery Charging/ Working Time: 4h/ 6h (Charging time by A/C Power)

#### SPECIAL APPLICATIONS:

- Home & Office Lighting
- Emergency Lighting
- Portable Lighting
- Solar-Powered Lighting

#### SPECIAL FUNCTIONS:

- Fitted with three solar panels. It will charge in sunlight (8-9 hours) and give you 2-3 hours of lighting
- The solar bulb work like any household light bulb and charges at the same time. Take 4-5 hours to fully charge and give you 5 hours of lighting with the battery in case of power failure (the switch must be turned to the on).

#### ΕΙΔΙΚΕΣ ΕΦΑΡΜΟΓΕΣ:

- Φωτισμός Οικίας & Γραφείου
- Εφεδρικός Φωτισμός
- Φορητός Φωτισμός
- Φωτισμός με ηλιακή ενέργεια

#### ΕΙΔΙΚΕΣ ΛΕΙΤΟΥΡΓΙΕΣ:

- Εφοδιασμένος με τρεις ηλιακούς συλλέκτες, θα φορτίσει στο ηλιακό φως (8-9 ώρες) για να δώσει φωτισμό για 2-3 ώρες.
- Ο ηλιακός λαμπτήρας λειτουργεί όπως κάθε οικιακός λαμπτήρας, ενώ φορτίζεται ταυτόχρονα. Χρειάζεται 4-5 ώρες για να φορτίσει πλήρως και σας δίνει 5 ώρες φωτισμού με την μπαταρία, σε περίπτωση διακοπής ρεύματος (ο διακόπτης πρέπει να είναι ενεργοποιημένος).



|                                    |                           |                                  |                    |                                   |                    |                        |                            |                                   |   |
|------------------------------------|---------------------------|----------------------------------|--------------------|-----------------------------------|--------------------|------------------------|----------------------------|-----------------------------------|---|
| <b>VOLT</b><br>100-240V<br>50-60Hz | <b>BEAM ANGLE</b><br>120° | <b>IP</b><br>PANEL 65<br>BULB 20 | <b>PF</b><br>>0.90 | <b>Ra</b> <sup>(CRI)</sup><br>>80 | <b>Hg</b><br>0.00% | <b>ON-OFF</b><br>25000 | <b>LIFE TIME</b><br>50000h | <b>START TIME min:</b><br>0.5 sec | <b>OPERATING TEMP.</b><br>-20°C ~ +45°C |
| BARCODE                            | CODE                      | BASE                             | TYPE               | WATT =WATT                        | KELVIN             | LUMEN                  | mm                         | PACKING                           | PRICE (€)                               |
| 5206139072658                      | 145-20001                 | E27                              | A70                | 7W 40W                            | 7000K - 8000K      | 560                    | 154                        | 72 1/16                           | 38.40                                   |

|                                   |                           |                 |                    |                                   |                    |                        |                            |                                   |   |
|-----------------------------------|---------------------------|-----------------|--------------------|-----------------------------------|--------------------|------------------------|----------------------------|-----------------------------------|---|
| <b>VOLT</b><br>86-265V<br>50-60Hz | <b>BEAM ANGLE</b><br>230° | <b>IP</b><br>65 | <b>PF</b><br>>0.50 | <b>Ra</b> <sup>(CRI)</sup><br>>80 | <b>Hg</b><br>0.00% | <b>ON-OFF</b><br>25000 | <b>LIFE TIME</b><br>25000h | <b>START TIME min:</b><br>0.5 sec | <b>OPERATING TEMP.</b><br>-30°C ~ +45°C |
| BARCODE                           | CODE                      | BASE            | TYPE               | WATT =WATT                        | KELVIN             | LUMEN                  | mm                         | PACKING                           | PRICE (€)                               |
| 5207227033025                     | 145-20003                 | E27             | A70                | 7W 40W                            | 6500K              | 450                    | 134                        | 70 1/10/100                       | 9.85                                    |

• LED SMD BULB WITH DAY-NIGHT SENSOR  
 • ΛΑΜΠΤΗΡΑΣ LED SMD ΜΕ ΑΙΣΘΗΤΗΡΑ ΗΜΕΡΑΣ-ΝΥΧΤΑΣ  
 A60 - E27



PRODUCTION MATERIAL: PLASTIC WITH ALUMINIUM HEATSINK  
 ΥΛΙΚΟ ΚΑΤΑΣΚΕΥΗΣ: ΠΛΑΣΤΙΚΟ ΜΕ ΨΥΚΤΡΑ ΑΛΟΥΜΙΝΙΟΥ

- Ανάβει αυτόματα όταν το φως του περιβάλλοντα χώρου είναι κάτω από 20 LUX
- Lights up automatically when the room light is below 20 LUX

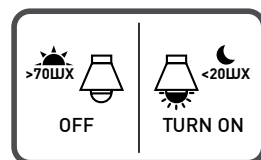

- Σβήνει αυτόματα όταν το φως του περιβάλλοντα χώρου είναι επαρκές (πάνω από 70 LUX)
- Switches off automatically when room light is sufficient (over 70 LUX)



|                     |            |       |          |            |        |           |                 |                 |           |
|---------------------|------------|-------|----------|------------|--------|-----------|-----------------|-----------------|-----------|
| VOLT                | BEAM ANGLE | PF    | Ra (CRI) | Hg         | ON-OFF | LIFE TIME | START TIME min: | OPERATING TEMP. |           |
| 170-265V<br>50-60Hz | 180°       | >0.90 | >80      | 0.00%      | 25000  | 30000h    | 0.5 sec         | -30°C ~ +45°C   |           |
| BARCODE             | CODE       | BASE  | TYPE     | WATT =WATT | KELVIN | LUMEN     | mm              | PACKING         | PRICE (€) |
| 5207227059001       | 147-84931  | E27   | A60      | 10W 70W    | 4000K  | 900       | 108 60          | 1/10/50         | 10.90     |

• LED SMD BULB WITH MOTION DETECTOR  
 • ΛΑΜΠΤΗΡΑΣ LED SMD ΜΕ ΑΙΣΘΗΤΗΡΑ ΚΙΝΗΣΗΣ  
 A60 - E27



PRODUCTION MATERIAL: PLASTIC WITH ALUMINIUM HEATSINK  
 ΥΛΙΚΟ ΚΑΤΑΣΚΕΥΗΣ: ΠΛΑΣΤΙΚΟ ΜΕ ΨΥΚΤΡΑ ΑΛΟΥΜΙΝΙΟΥ

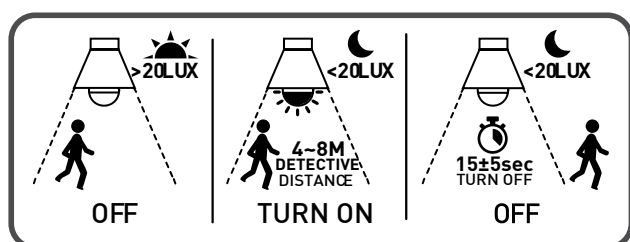

- Ανάβει αυτόματα όταν εντοπιστεί κίνηση (range: 4 - 8m) & όταν το φως του περιβάλλοντα χώρου είναι κάτω από 20 LUX
- Lights up automatically when it detects motion (range: 4 - 8m) & when the room light is below 20 LUX
- Παραμένει αναμμένος για 15sec αφού εντοπιστεί κίνηση
- Remains on for 15sec after detecting movement



|                     |            |       |          |            |        |           |                 |                 |           |
|---------------------|------------|-------|----------|------------|--------|-----------|-----------------|-----------------|-----------|
| VOLT                | BEAM ANGLE | PF    | Ra (CRI) | Hg         | ON-OFF | LIFE TIME | START TIME min: | OPERATING TEMP. |           |
| 220-240V<br>50-60Hz | 180°       | >0.90 | >80      | 0.00%      | 25000  | 30000h    | 0.5 sec         | -30°C ~ +45°C   |           |
| BARCODE             | CODE       | BASE  | TYPE     | WATT =WATT | KELVIN | LUMEN     | mm              | PACKING         | PRICE (€) |
| 5207227057397       | 147-84936  | E27   | A60      | 12W 75W    | 4000K  | 1055      | 120 60          | 1/10/50         | 11.90     |

• LED SMD INSECT REPELLENT BULB / A60 - E27  
 • ΛΑΜΠΤΗΡΑΣ LED SMD ΕΝΤΟΜΟΑΠΩΘΗΤΙΚΟΣ / A60 - E27



PRODUCTION MATERIAL: PLASTIC WITH ALUMINIUM HEATSINK  
 ΥΛΙΚΟ ΚΑΤΑΣΚΕΥΗΣ: ΠΛΑΣΤΙΚΟ ΜΕ ΨΥΚΤΡΑ ΑΛΟΥΜΙΝΙΟΥ



|                     |            |       |       |        |           |                 |                 |           |
|---------------------|------------|-------|-------|--------|-----------|-----------------|-----------------|-----------|
| VOLT                | BEAM ANGLE | PF    | Hg    | ON-OFF | LIFE TIME | START TIME min: | OPERATING TEMP. |           |
| 220-240V<br>50-60Hz | 360°       | >0.65 | 0.00% | 25000  | 25000h    | 0.5 sec         | -30°C ~ +45°C   |           |
| BARCODE             | CODE       | BASE  | TYPE  | WATT   | KELVIN    | mm              | PACKING         | PRICE (€) |
| 5207227011290       | 147-80981  | E27   | A60   | 7W     | YELLOW    | 105 60          | 1/10/50         | 6.45      |

• LED FILAMENT SILVER MIRROR BULB  
 • ΛΑΜΠΤΗΡΑΣ LED FILAMENT ΑΝΕΣΤΡΑΜΜΕΝΟΥ ΚΑΘΡΕΠΤΟΥ  
 DIMMABLE / A60 - E27



PRODUCTION MATERIAL: GLASS WITH ALUMINIUM BASE  
 ΥΛΙΚΟ ΚΑΤΑΣΚΕΥΗΣ: ΓΥΑΛΙ ΜΕ ΒΑΣΗ ΑΛΟΥΜΙΝΙΟΥ



|                     |            |       |          |            |        |           |                 |                 |           |
|---------------------|------------|-------|----------|------------|--------|-----------|-----------------|-----------------|-----------|
| VOLT                | BEAM ANGLE | PF    | Ra (CRI) | Hg         | ON-OFF | LIFE TIME | START TIME min: | OPERATING TEMP. |           |
| 220-240V<br>50-60Hz | 360°       | >0.90 | >80      | 0.00%      | 25000  | 25000h    | 0.5 sec         | -30°C ~ +45°C   |           |
| BARCODE             | CODE       | BASE  | TYPE     | WATT =WATT | KELVIN | LUMEN     | mm              | PACKING         | PRICE (€) |
| 5206139035677       | 147-80960  | E27   | A60      | 6W 50W     | 2700K  | 650       | 106 60          | 1/10/50         | 9.60      |

• LED SMD BLACK LIGHT BULB  
 • ΛΑΜΠΤΗΡΑΣ LED SMD BLACK LIGHT  
 A60 - E27



PRODUCTION MATERIAL: PLASTIC WITH ALUMINIUM HEATSINK  
 ΥΛΙΚΟ ΚΑΤΑΣΚΕΥΗΣ: ΠΛΑΣΤΙΚΟ ΜΕ ΨΥΚΤΡΑ ΑΛΟΥΜΙΝΙΟΥ



|                     |            |       |       |        |             |                 |                 |           |
|---------------------|------------|-------|-------|--------|-------------|-----------------|-----------------|-----------|
| VOLT                | BEAM ANGLE | PF    | Hg    | ON-OFF | LIFE TIME   | START TIME min: | OPERATING TEMP. |           |
| 220-240V<br>50-60Hz | 200°       | >0.65 | 0.00% | 25000  | 25000h      | 0.5 sec         | -30°C ~ +45°C   |           |
| BARCODE             | CODE       | BASE  | TYPE  | WATT   | KELVIN      | mm              | PACKING         | PRICE (€) |
| 5207227058141       | 147-84940  | E27   | A60   | 6W     | ULTRAVIOLET | 111 60          | 1/10/50         | 7.75      |

"TOULIP" / TYPE: S



TYPE: "MANOLIA"



"AJAX" / TYPE: SL



"HAMMER" / TYPE: T



Επαγγελματικής Χρήσης / Professional Use

Types: MAGNOLIA / T / SL / S

Discover our Collection ►

**LED**

SMD Professional Use Series

• LED SMD BULBS - PROFESSIONAL / INDUSTRIAL USE  
 • ΛΑΜΠΤΗΡΕΣ LED SMD - ΕΠΑΓΓΕΛΜΑΤΙΚΗΣ / ΒΙΟΜΗΧΑΝΙΚΗΣ ΧΡΗΣΗΣ  
 "AJAX" / SL - E27



PRODUCTION MATERIAL:  
**ALUMINIUM & PLASTIC WITH PRISMATIC COVER & DIFFUSER**  
 ΥΛΙΚΟ ΚΑΤΑΣΚΕΥΗΣ:  
**ΑΛΟΥΜΙΝΙΟ & ΠΛΑΣΤΙΚΟ ΜΕ ΠΡΙΣΜΑΤΙΚΟ ΚΑΛΥΜΜΑ & ΔΙΑΧΥΤΗΣ**

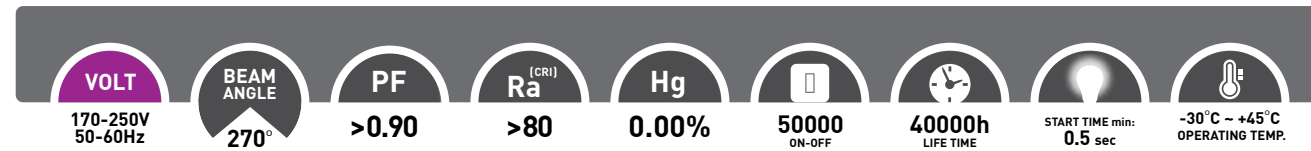

| BARCODE       | CODE      | BASE | TYPE | WATT | LM/W | KELVIN | LUMEN | mm     | PACKING | PRICE (€) |
|---------------|-----------|------|------|------|------|--------|-------|--------|---------|-----------|
| 5207227063916 | 147-76500 | E27  | SL   | 15W  | 100  | 6500K  | 1500  | 149 65 | 1/10/50 | 10.15     |
| 5207227063947 | 147-76501 | E27  | SL   | 15W  | 100  | 4000K  | 1500  | 149 65 | 1/10/50 | 10.15     |
| 5207227063978 | 147-76502 | E27  | SL   | 15W  | 100  | 2700K  | 1500  | 149 65 | 1/10/50 | 10.15     |
| 5207227064005 | 147-76506 | E27  | SL   | 20W  | 100  | 6500K  | 2000  | 169 65 | 1/10/50 | 13.40     |
| 5207227064036 | 147-76507 | E27  | SL   | 20W  | 100  | 4000K  | 2000  | 169 65 | 1/10/50 | 13.40     |
| 5207227064067 | 147-76508 | E27  | SL   | 20W  | 100  | 2700K  | 2000  | 169 65 | 1/10/50 | 13.40     |



PRODUCTION MATERIAL:  
**GLASS WITH ALUMINIUM HEATSINK**  
 ΥΛΙΚΟ ΚΑΤΑΣΚΕΥΗΣ:  
**ΓΥΑΛΙ ΜΕ ΨΥΚΤΡΑ ΑΛΟΥΜΙΝΙΟΥ**

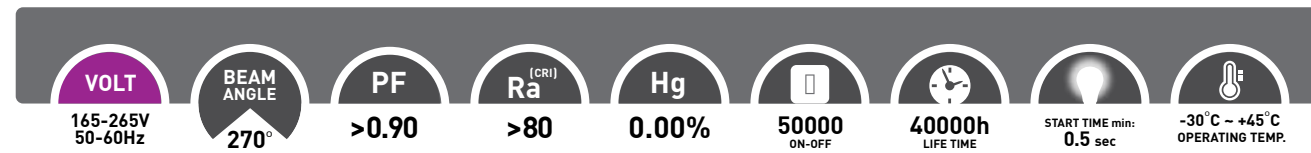

| BARCODE       | CODE      | BASE | TYPE | WATT | LM/W | KELVIN | LUMEN | mm     | PACKING | PRICE (€) |
|---------------|-----------|------|------|------|------|--------|-------|--------|---------|-----------|
| 5206139027429 | 147-84540 | E27  | SL   | 15W  | 103  | 6500K  | 1550  | 150 64 | 1/10/50 | 13.10     |
| 5206139039859 | 147-84541 | E27  | SL   | 15W  | 103  | 2700K  | 1550  | 150 64 | 1/10/50 | 13.10     |
| 5207227003158 | 147-84546 | E27  | SL   | 15W  | 103  | 4000K  | 1550  | 150 64 | 1/10/50 | 13.10     |

• LED SMD BULBS - PROFESSIONAL / INDUSTRIAL USE  
 • ΛΑΜΠΤΗΡΕΣ LED SMD - ΕΠΑΓΓΕΛΜΑΤΙΚΗΣ / ΒΙΟΜΗΧΑΝΙΚΗΣ ΧΡΗΣΗΣ  
 "HAMMER" / T80 - E27



PRODUCTION MATERIAL: **PLASTIC WITH ALUMINIUM HEATSINK**  
 ΥΛΙΚΟ ΚΑΤΑΣΚΕΥΗΣ: **ΠΛΑΣΤΙΚΟ ΜΕ ΨΥΚΤΡΑ ΑΛΟΥΜΙΝΙΟΥ**

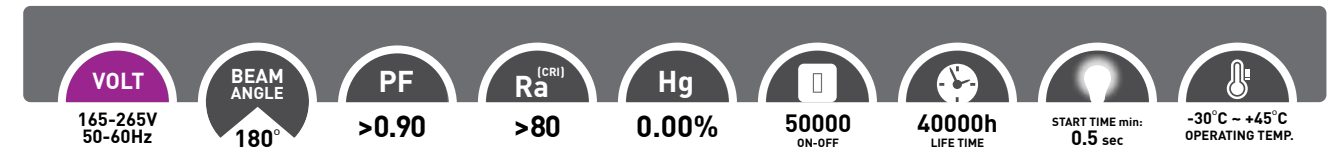
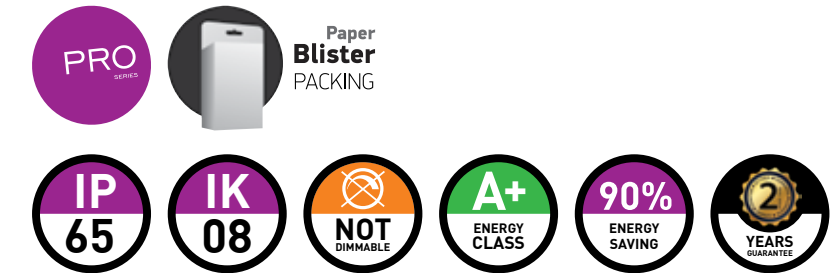

| BARCODE       | CODE      | BASE | TYPE | WATT | LM/W | KELVIN | LUMEN | mm     | PACKING | PRICE (€) |
|---------------|-----------|------|------|------|------|--------|-------|--------|---------|-----------|
| 5206139074317 | 147-84542 | E27  | T80  | 16W  | 99   | 6500K  | 1580  | 145 80 | 1/50    | 6.65      |
| 5207227032967 | 147-84543 | E27  | T80  | 16W  | 99   | 4000K  | 1580  | 145 80 | 1/50    | 6.65      |
| 5206139074331 | 147-84544 | E27  | T80  | 16W  | 99   | 2700K  | 1580  | 145 80 | 1/50    | 6.65      |



"HAMMER" / T100 - E27

PRODUCTION MATERIAL: **PLASTIC WITH ALUMINIUM HEATSINK**  
 ΥΛΙΚΟ ΚΑΤΑΣΚΕΥΗΣ: **ΠΛΑΣΤΙΚΟ ΜΕ ΨΥΚΤΡΑ ΑΛΟΥΜΙΝΙΟΥ**

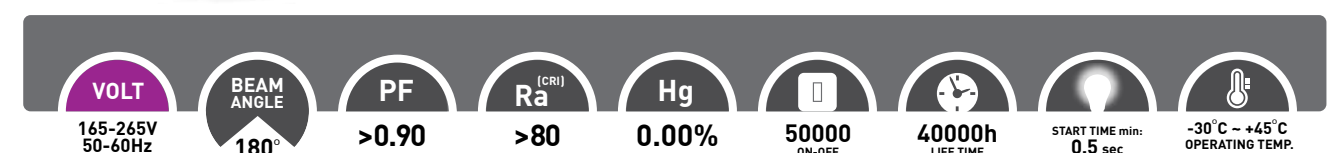

| BARCODE       | CODE      | BASE | TYPE | WATT | LM/W | KELVIN | LUMEN | mm      | PACKING | PRICE (€) |
|---------------|-----------|------|------|------|------|--------|-------|---------|---------|-----------|
| 5207227010828 | 147-84536 | E27  | T100 | 28W  | 100  | 6500K  | 2800  | 185 100 | 1/40    | 9.70      |
| 5207227037887 | 147-84537 | E27  | T100 | 28W  | 100  | 4000K  | 2800  | 185 100 | 1/40    | 9.70      |

- LED SMD BULBS - PROFESSIONAL / INDUSTRIAL USE
- ΛΑΜΠΤΗΡΕΣ LED SMD - ΕΠΑΓΓΕΛΜΑΤΙΚΗΣ / ΒΙΟΜΗΧΑΝΙΚΗΣ ΧΡΗΣΗΣ



### “HAMMER” / T115 - E27

PRODUCTION MATERIAL: **PLASTIC WITH ALUMINIUM HEATSINK**  
 ΥΛΙΚΟ ΚΑΤΑΣΚΕΥΗΣ: **ΠΛΑΣΤΙΚΟ ΜΕ ΨΥΚΤΡΑ ΑΛΟΥΜΙΝΙΟΥ**

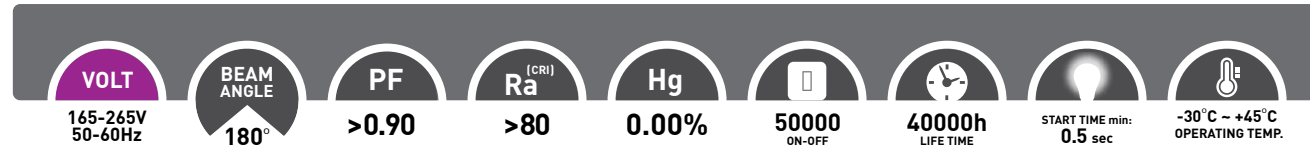
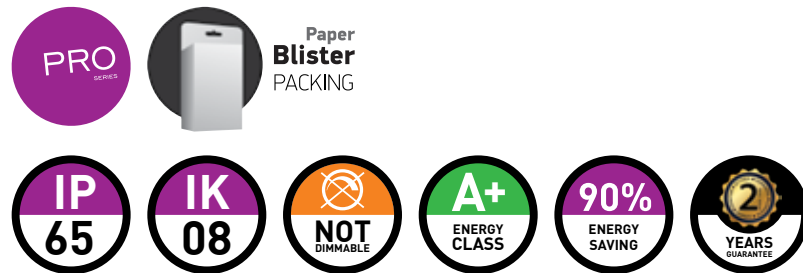

| BARCODE       | CODE      | BASE | TYPE | WATT | LM/W | KELVIN | LUMEN | mm      | PACKING | PRICE (€) |
|---------------|-----------|------|------|------|------|--------|-------|---------|---------|-----------|
| 5207227010842 | 147-84538 | E27  | T115 | 38W  | 100  | 6500K  | 3800  | 205 115 | 1/40    | 16.85     |
| 5207227037900 | 147-84539 | E27  | T115 | 38W  | 100  | 4000K  | 3800  | 205 115 | 1/40    | 16.85     |



### “HAMMER” / T100 - E27

PRODUCTION MATERIAL: **PLASTIC WITH ALUMINIUM HEATSINK**  
 ΥΛΙΚΟ ΚΑΤΑΣΚΕΥΗΣ: **ΠΛΑΣΤΙΚΟ ΜΕ ΨΥΚΤΡΑ ΑΛΟΥΜΙΝΙΟΥ**

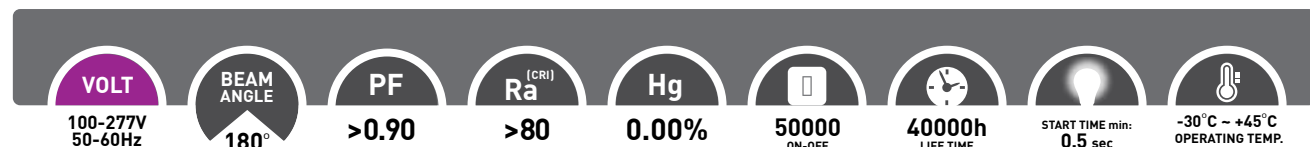
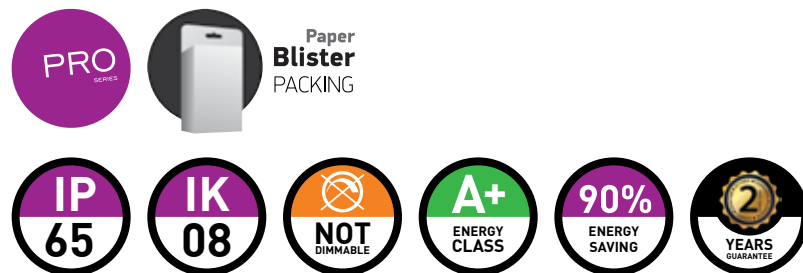

| BARCODE       | CODE      | BASE | TYPE | WATT | LM/W | KELVIN | LUMEN | mm      | PACKING | PRICE (€) |
|---------------|-----------|------|------|------|------|--------|-------|---------|---------|-----------|
| 5207227064326 | 147-76545 | E27  | T100 | 40W  | 100  | 6500K  | 4000  | 180 100 | 1/40    | 18.65     |
| 5207227064333 | 147-76546 | E27  | T100 | 40W  | 100  | 4000K  | 4000  | 180 100 | 1/40    | 18.65     |
| 5207227072871 | 147-76547 | E27  | T100 | 40W  | 100  | 2700K  | 4000  | 180 100 | 1/40    | 18.65     |

- LED SMD BULBS - PROFESSIONAL / INDUSTRIAL USE
- ΛΑΜΠΤΗΡΕΣ LED SMD - ΕΠΑΓΓΕΛΜΑΤΙΚΗΣ / ΒΙΟΜΗΧΑΝΙΚΗΣ ΧΡΗΣΗΣ



### “HAMMER” / T125 - E27

PRODUCTION MATERIAL: **PLASTIC WITH ALUMINIUM HEATSINK**  
 ΥΛΙΚΟ ΚΑΤΑΣΚΕΥΗΣ: **ΠΛΑΣΤΙΚΟ ΜΕ ΨΥΚΤΡΑ ΑΛΟΥΜΙΝΙΟΥ**

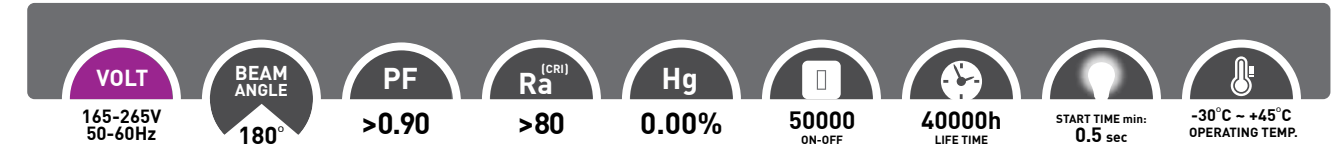
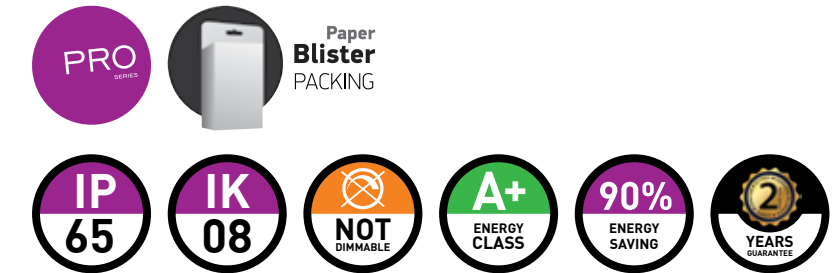

| BARCODE       | CODE      | BASE | TYPE | WATT | LM/W | KELVIN | LUMEN | mm      | PACKING | PRICE (€) |
|---------------|-----------|------|------|------|------|--------|-------|---------|---------|-----------|
| 5207227021381 | 147-84530 | E27  | T125 | 50W  | 100  | 6500K  | 5000  | 237 125 | 1/20    | 20.55     |
| 5206139070821 | 147-84531 | E27  | T125 | 50W  | 100  | 4000K  | 5000  | 237 125 | 1/20    | 20.55     |



### “HAMMER” / T140 / T160 E27 + E40 (with adaptor)

PRODUCTION MATERIAL: **PLASTIC WITH ALUMINIUM HEATSINK**  
 ΥΛΙΚΟ ΚΑΤΑΣΚΕΥΗΣ: **ΠΛΑΣΤΙΚΟ ΜΕ ΨΥΚΤΡΑ ΑΛΟΥΜΙΝΙΟΥ**

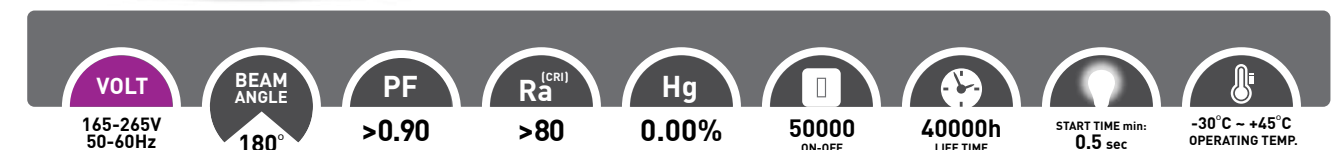

| BARCODE       | CODE      | BASE      | TYPE | IP | WATT | LM/W | KELVIN | LUMEN | mm      | PACKING | PRICE (€) |
|---------------|-----------|-----------|------|----|------|------|--------|-------|---------|---------|-----------|
| 5207227021404 | 147-84532 | E27 + E40 | T140 | 65 | 100W | 100  | 6500K  | 10000 | 296 142 | 1/20    | 60.65     |
| 5206139070845 | 147-84533 | E27 + E40 | T140 | 65 | 100W | 100  | 4000K  | 9940  | 296 142 | 1/20    | 60.65     |
| 5206139080097 | 147-84534 | E27 + E40 | T160 | 44 | 200W | 100  | 6500K  | 20000 | 327 161 | 1/15    | 87.65     |
| 5206139070869 | 147-84535 | E27 + E40 | T160 | 44 | 200W | 100  | 4000K  | 19880 | 327 161 | 1/15    | 87.65     |

- LED SMD BULBS - PROFESSIONAL / INDUSTRIAL USE
- ΛΑΜΠΤΗΡΕΣ LED SMD - ΕΠΑΓΓΕΛΜΑΤΙΚΗΣ / ΒΙΟΜΗΧΑΝΙΚΗΣ ΧΡΗΣΗΣ

“MAGNOLIA” - E27



PRODUCTION MATERIAL:  
PLASTIC WITH ALUMINIUM HEATSINK  
ΥΛΙΚΟ ΚΑΤΑΣΚΕΥΗΣ:  
ΠΛΑΣΤΙΚΟ ΜΕ ΨΥΚΤΡΑ ΑΛΟΥΜΙΝΙΟΥ



• Μόνο για κάθετη τοποθέτηση - ΟΧΙ οριζόντια  
• Only for vertical installation - NOT horizontal

VOLT: 180-265V 50-60Hz | BEAM ANGLE: 360° | PF: >0.90 | Ra: >80 | Hg: 0.00% | 50000 ON-OFF | 40000h LIFE TIME | START TIME min: 0.5 sec | -30°C ~ +45°C OPERATING TEMP.

| BARCODE       | CODE       | BASE | TYPE     | WATT | LM/W | KELVIN | LUMEN | mm     | PACKING | PRICE (€) |
|---------------|------------|------|----------|------|------|--------|-------|--------|---------|-----------|
| 5207227063718 | 147-76010  | E27  | MAGNOLIA | 30W  | 115  | 6500K  | 3450  | 218 90 | 1/25    | 24.50     |
| 5207227063725 | 147-76011  | E27  | MAGNOLIA | 30W  | 115  | 4000K  | 3450  | 218 90 | 1/25    | 24.50     |
| 5207227063732 | 147-76012  | E27  | MAGNOLIA | 30W  | 115  | 2700K  | 3450  | 218 90 | 1/25    | 24.50     |
| 5207227055928 | 147-80804* | E27  | MAGNOLIA | 30W  | 115  | 6500K  | 3450  | 212 90 | 1/30    | 24.50     |
| 5207227055942 | 147-80805* | E27  | MAGNOLIA | 30W  | 115  | 4000K  | 3450  | 212 90 | 1/30    | 24.50     |
| 5207227063749 | 147-76013  | E27  | MAGNOLIA | 40W  | 115  | 6500K  | 4600  | 218 90 | 1/25    | 29.50     |
| 5207227063756 | 147-76014  | E27  | MAGNOLIA | 40W  | 115  | 4000K  | 4600  | 218 90 | 1/25    | 29.50     |
| 5207227063763 | 147-76015  | E27  | MAGNOLIA | 40W  | 115  | 2700K  | 4600  | 218 90 | 1/25    | 29.50     |
| 5207227059728 | 147-76020  | E27  | MAGNOLIA | 50W  | 115  | 6500K  | 5750  | 218 90 | 1/25    | 34.50     |
| 5207227059742 | 147-76021  | E27  | MAGNOLIA | 50W  | 115  | 4000K  | 5750  | 218 90 | 1/25    | 34.50     |
| 5207227063787 | 147-76022  | E27  | MAGNOLIA | 50W  | 115  | 2700K  | 5750  | 218 90 | 1/25    | 34.50     |

147-80804\* Ο κωδικός αυτός ισχύει μέχρι εξαντλήσεως του αποθέματος και αντικαταστάθηκε από τον πανομοιότυπο κωδικό: 147-76010  
This code is valid until stock is exhausted and replaced by identical code:

147-80805\* Ο κωδικός αυτός ισχύει μέχρι εξαντλήσεως του αποθέματος και αντικαταστάθηκε από τον πανομοιότυπο κωδικό: 147-76011  
This code is valid until stock is exhausted and replaced by identical code:

- LED SMD BULBS - PROFESSIONAL / INDUSTRIAL USE
- ΛΑΜΠΤΗΡΕΣ LED SMD - ΕΠΑΓΓΕΛΜΑΤΙΚΗΣ / ΒΙΟΜΗΧΑΝΙΚΗΣ ΧΡΗΣΗΣ

“MAGNOLIA” - E40



PRODUCTION MATERIAL:  
PLASTIC WITH ALUMINIUM HEATSINK  
ΥΛΙΚΟ ΚΑΤΑΣΚΕΥΗΣ:  
ΠΛΑΣΤΙΚΟ ΜΕ ΨΥΚΤΡΑ ΑΛΟΥΜΙΝΙΟΥ



• Μόνο για κάθετη τοποθέτηση - ΟΧΙ οριζόντια  
• Only for vertical installation - NOT horizontal

VOLT: 180-265V 50-60Hz | BEAM ANGLE: 360° | PF: >0.90 | Ra: >80 | Hg: 0.00% | 50000 ON-OFF | 40000h LIFE TIME | START TIME min: 0.5 sec | -30°C ~ +45°C OPERATING TEMP.

| BARCODE       | CODE       | BASE | TYPE     | WATT | LM/W | KELVIN | LUMEN | mm      | PACKING | PRICE (€) |
|---------------|------------|------|----------|------|------|--------|-------|---------|---------|-----------|
| 5207227063800 | 147-76023  | E40  | MAGNOLIA | 60W  | 105  | 6500K  | 6300  | 285 120 | 1/10    | 39.10     |
| 5207227060915 | 147-76024  | E40  | MAGNOLIA | 60W  | 105  | 4000K  | 6300  | 285 120 | 1/10    | 39.10     |
| 5207227063824 | 147-76025  | E40  | MAGNOLIA | 60W  | 105  | 2700K  | 6300  | 285 120 | 1/10    | 39.10     |
| 5207227055904 | 147-80820* | E40  | MAGNOLIA | 60W  | 105  | 6500K  | 6300  | 290 122 | 1/10    | 39.10     |
| 5207227063831 | 147-76026  | E40  | MAGNOLIA | 70W  | 105  | 6500K  | 7350  | 285 120 | 1/10    | 43.50     |
| 5207227063848 | 147-76027  | E40  | MAGNOLIA | 70W  | 105  | 4000K  | 7350  | 285 120 | 1/10    | 43.50     |
| 5207227063855 | 147-76028  | E40  | MAGNOLIA | 70W  | 105  | 2700K  | 7350  | 285 120 | 1/10    | 43.50     |
| 5207227060892 | 147-76030  | E40  | MAGNOLIA | 80W  | 105  | 6500K  | 8400  | 285 120 | 1/10    | 48.00     |
| 5207227063879 | 147-76031  | E40  | MAGNOLIA | 80W  | 105  | 4000K  | 8400  | 285 120 | 1/10    | 48.00     |
| 5207227063893 | 147-76032  | E40  | MAGNOLIA | 80W  | 105  | 2700K  | 8400  | 285 120 | 1/10    | 48.00     |

147-80820\* Ο κωδικός αυτός ισχύει μέχρι εξαντλήσεως του αποθέματος και αντικαταστάθηκε από τον πανομοιότυπο κωδικό: 147-76023  
This code is valid until stock is exhausted and replaced by identical code:

- LED SMD BULBS - PROFESSIONAL / INDUSTRIAL USE
- ΛΑΜΠΤΗΡΕΣ LED SMD - ΕΠΑΓΓΕΛΜΑΤΙΚΗΣ / ΒΙΟΜΗΧΑΝΙΚΗΣ ΧΡΗΣΗΣ

**“MAGNOLIA” - E27**

PRODUCTION MATERIAL:  
**PLASTIC WITH ALUMINIUM HEATSINK**  
 ΥΛΙΚΟ ΚΑΤΑΣΚΕΥΗΣ:  
**ΠΛΑΣΤΙΚΟ ΜΕ ΨΥΚΤΡΑ ΑΛΟΥΜΙΝΙΟΥ**



Is equivalent to a **MERCURY LAMP**  
**125W**  
 Ισοδυναμεί με λαμπτήρα **ΥΔΡΑΡΓΥΡΟΥ**  
**125W**

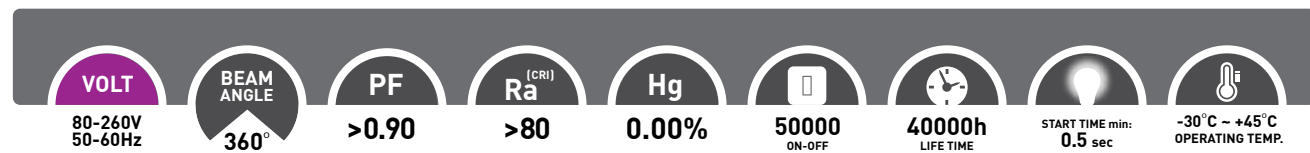

| BARCODE       | CODE      | BASE | TYPE     | WATT | LM/W | KELVIN | LUMEN | mm  | mm | PACKING | PRICE (€) |
|---------------|-----------|------|----------|------|------|--------|-------|-----|----|---------|-----------|
| 5206139038586 | 147-80801 | E27  | MAGNOLIA | 30W  | 110  | 6500K  | 3300  | 178 | 76 | 1/10    | 29.90     |
| 5206139043306 | 147-80802 | E27  | MAGNOLIA | 30W  | 110  | 4000K  | 3300  | 178 | 76 | 1/10    | 29.90     |
| 5206139043313 | 147-80803 | E27  | MAGNOLIA | 30W  | 110  | 2700K  | 3300  | 178 | 76 | 1/10    | 29.90     |

- LED SMD BULBS - PROFESSIONAL / INDUSTRIAL USE
- ΛΑΜΠΤΗΡΕΣ LED SMD - ΕΠΑΓΓΕΛΜΑΤΙΚΗΣ / ΒΙΟΜΗΧΑΝΙΚΗΣ ΧΡΗΣΗΣ

**“TOULIP” S280 / S300 - E40**

PRODUCTION MATERIAL:  
**PLASTIC WITH ALUMINIUM HEATSINK**  
 ΥΛΙΚΟ ΚΑΤΑΣΚΕΥΗΣ:  
**ΠΛΑΣΤΙΚΟ ΜΕ ΨΥΚΤΡΑ ΑΛΟΥΜΙΝΙΟΥ**



S300



S280

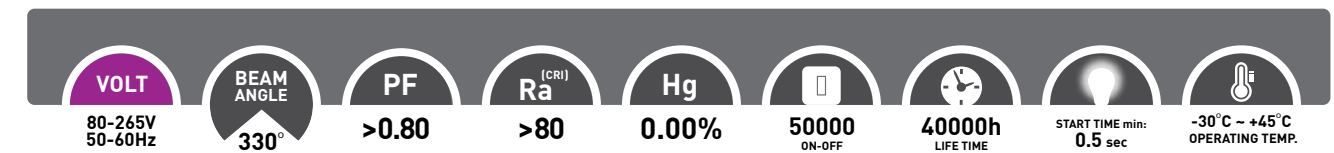

| BARCODE       | CODE      | BASE | TYPE | WATT | LM/W | KELVIN | LUMEN | mm  | mm  | PACKING | PRICE (€) |
|---------------|-----------|------|------|------|------|--------|-------|-----|-----|---------|-----------|
| 5206139070883 | 147-80830 | E40  | S280 | 48W  | 125  | 6500K  | 6000  | 280 | 95  | 1/10    | 63.85     |
| 5207227026201 | 147-80831 | E40  | S280 | 48W  | 125  | 4000K  | 6000  | 280 | 95  | 1/10    | 63.85     |
| 5207227001505 | 147-80836 | E40  | S300 | 58W  | 125  | 6500K  | 7250  | 285 | 113 | 1/6     | 73.20     |
| 5207227004223 | 147-80837 | E40  | S300 | 58W  | 125  | 4000K  | 7250  | 285 | 113 | 1/6     | 73.20     |
| 5206139080110 | 147-80834 | E40  | S300 | 80W  | 125  | 4000K  | 10000 | 300 | 113 | 1/6     | 77.65     |
| 5206139070920 | 147-80835 | E40  | S300 | 80W  | 125  | 2700K  | 10000 | 300 | 113 | 1/6     | 77.65     |

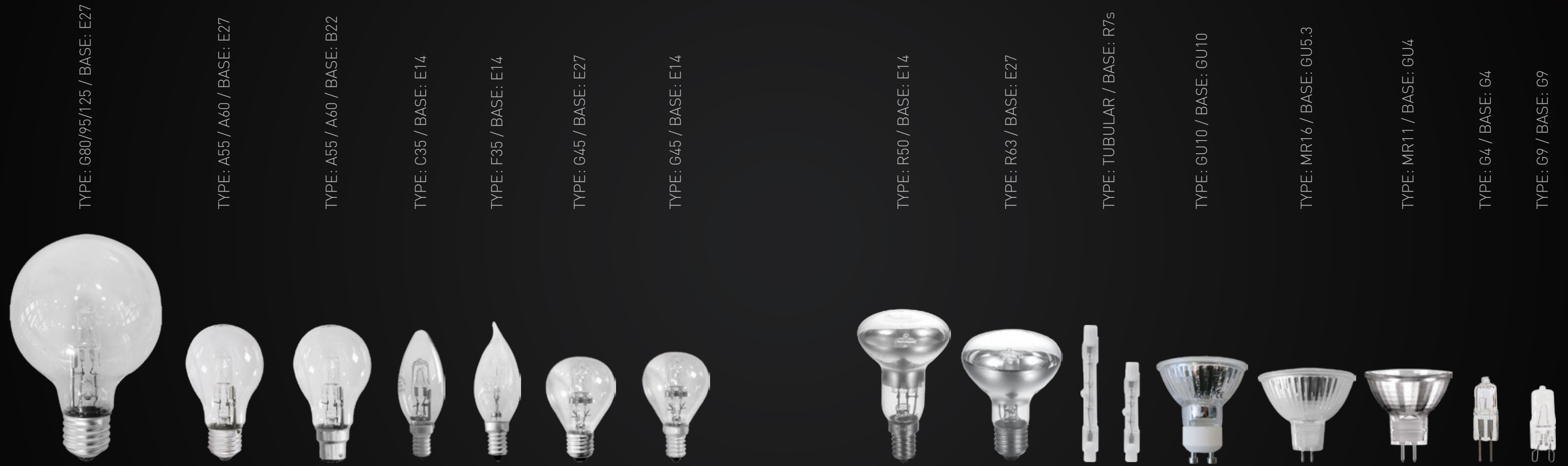

TYPE: G80/95/125 / BASE: E27

TYPE: A55 / A60 / BASE: E27

TYPE: A55 / A60 / BASE: B22

TYPE: C35 / BASE: E14

TYPE: F35 / BASE: E14

TYPE: G45 / BASE: E27

TYPE: G45 / BASE: E14

TYPE: R50 / BASE: E14

TYPE: R63 / BASE: E27

TYPE: TUBULAR / BASE: R7s

TYPE: GU10 / BASE: GU10

TYPE: MR16 / BASE: GU5.3

TYPE: MR11 / BASE: GU4

TYPE: G4 / BASE: G4

TYPE: G9 / BASE: G9

Type:  
A / C / F / G / R7s / GU10 / MR11 / MR16 / R50 / R63

HALOGEN Bulbs

Discover our Collection ►

• HALOGEN BULBS • ΛΑΜΠΤΗΡΕΣ ΑΛΟΓΟΝΟΥ  
A55 / A60 - E27 / B22

PRODUCTION MATERIAL: **GLASS + ALUMINIUM BASE**  
ΥΛΙΚΟ ΚΑΤΑΣΚΕΥΗΣ: **ΓΥΑΛΙ + ΒΑΣΗ ΑΛΟΥΜΙΝΙΟΥ**

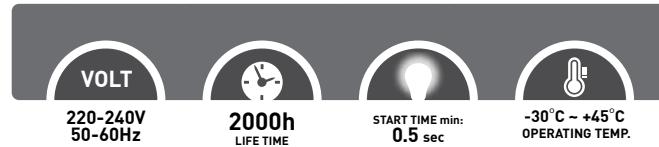
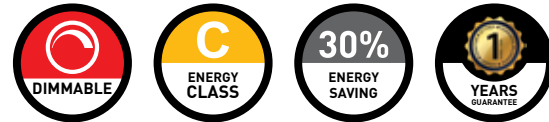

| BARCODE       | CODE       | BASE | TYPE | WATT | LUMEN | ↑ mm | ∅  | PACKING  | PRICE (€) |
|---------------|------------|------|------|------|-------|------|----|----------|-----------|
| 5206139048554 | 147-88254  | E27  | A55  | 18W  | 204   | 98   | 55 | 1/10/100 | 1.20      |
| 5206139097637 | 147-882550 | E27  | A55  | 53W  | 835   | 98   | 55 | 1/10/100 | 1.20      |
| 5206139001566 | 147-882560 | E27  | A55  | 28W  | 370   | 98   | 55 | 1/10/100 | 1.20      |
| 5206139001573 | 147-882570 | E27  | A55  | 42W  | 630   | 98   | 55 | 1/10/100 | 1.20      |
| 5206139001580 | 147-882580 | E27  | A55  | 70W  | 1180  | 98   | 55 | 1/10/100 | 1.20      |
| 5206139001603 | 147-882600 | B22  | A55  | 42W  | 630   | 98   | 55 | 1/10/100 | 1.20      |
| 5206139010612 | 147-882610 | B22  | A55  | 70W  | 1180  | 98   | 55 | 1/10/100 | 1.20      |
| 5206139021229 | 147-882590 | E27  | A60  | 105W | 1700  | 107  | 60 | 1/10/100 | 1.95      |

• HALOGEN BULBS • ΛΑΜΠΤΗΡΕΣ ΑΛΟΓΟΝΟΥ  
A55 - E27  
**BLISTER**

PRODUCTION MATERIAL: **GLASS + ALUMINIUM BASE**  
ΥΛΙΚΟ ΚΑΤΑΣΚΕΥΗΣ: **ΓΥΑΛΙ + ΒΑΣΗ ΑΛΟΥΜΙΝΙΟΥ**

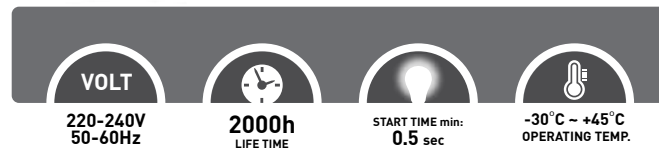

| BARCODE       | CODE       | BASE | TYPE | WATT | LUMEN | ↑ mm | ∅  | PACKING | PRICE (€) |
|---------------|------------|------|------|------|-------|------|----|---------|-----------|
| 5206139182579 | 800-882610 | E27  | A55  | 42W  | 630   | 98   | 55 | 1/10/60 | 1.49      |
| 5206139182586 | 800-882620 | E27  | A55  | 70W  | 1180  | 98   | 55 | 1/10/60 | 1.49      |
| 5206139039934 | 800-882630 | E27  | A55  | 53W  | 835   | 98   | 55 | 1/10/60 | 1.49      |

• HALOGEN BULBS • ΛΑΜΠΤΗΡΕΣ ΑΛΟΓΟΝΟΥ  
**MINION • C35 - E14**

PRODUCTION MATERIAL: **GLASS + ALUMINIUM BASE**  
ΥΛΙΚΟ ΚΑΤΑΣΚΕΥΗΣ: **ΓΥΑΛΙ + ΒΑΣΗ ΑΛΟΥΜΙΝΙΟΥ**

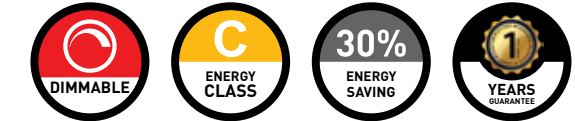

| BARCODE       | CODE       | BASE | TYPE | WATT | LUMEN | ↑ mm | ∅  | PACKING  | PRICE (€) |
|---------------|------------|------|------|------|-------|------|----|----------|-----------|
| 5206139031099 | 147-883490 | E14  | C35  | 18W  | 204   | 97   | 35 | 1/10/100 | 1.20      |
| 5206139003508 | 147-883500 | E14  | C35  | 28W  | 370   | 97   | 35 | 1/10/100 | 1.20      |
| 5206139003515 | 147-883510 | E14  | C35  | 42W  | 630   | 97   | 35 | 1/10/100 | 1.20      |

• HALOGEN BULBS • ΛΑΜΠΤΗΡΕΣ ΑΛΟΓΟΝΟΥ  
**MINI CANDLE TAIL • F35 - E14**

PRODUCTION MATERIAL: **GLASS + ALUMINIUM BASE**  
ΥΛΙΚΟ ΚΑΤΑΣΚΕΥΗΣ: **ΓΥΑΛΙ + ΒΑΣΗ ΑΛΟΥΜΙΝΙΟΥ**

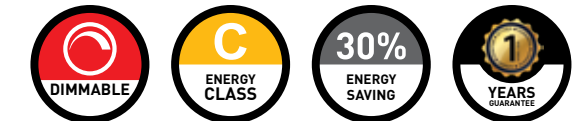
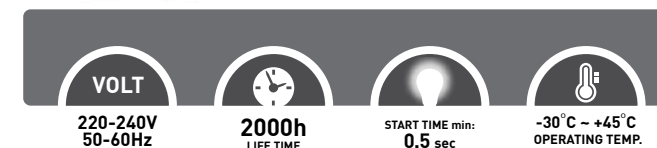

| BARCODE       | CODE      | BASE | TYPE | WATT | LUMEN | ↑ mm | ∅  | PACKING  | PRICE (€) |
|---------------|-----------|------|------|------|-------|------|----|----------|-----------|
| 5206139003522 | 147-88352 | E14  | F35  | 28W  | 370   | 100  | 35 | 1/10/100 | 1.36      |
| 5206139003539 | 147-88353 | E14  | F35  | 42W  | 630   | 100  | 35 | 1/10/100 | 1.36      |

• HALOGEN BULBS • ΛΑΜΠΤΗΡΕΣ ΑΛΟΓΟΝΟΥ  
**MINION • C35 - E14**  
**BLISTER**

PRODUCTION MATERIAL: **GLASS + ALUMINIUM BASE**  
ΥΛΙΚΟ ΚΑΤΑΣΚΕΥΗΣ: **ΓΥΑΛΙ + ΒΑΣΗ ΑΛΟΥΜΙΝΙΟΥ**

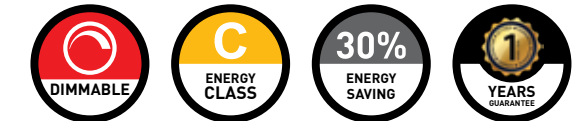
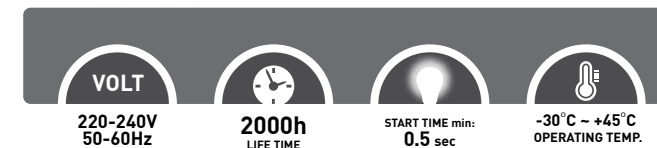

| BARCODE       | CODE       | BASE | TYPE | WATT | LUMEN | ↑ mm | ∅  | PACKING | PRICE (€) |
|---------------|------------|------|------|------|-------|------|----|---------|-----------|
| 5206139183507 | 800-883600 | E14  | C35  | 28W  | 370   | 97   | 35 | 1/10/60 | 1.49      |
| 5206139183514 | 800-883610 | E14  | C35  | 42W  | 630   | 97   | 35 | 1/10/60 | 1.49      |



• HALOGEN BULBS MINI GLOBE  
• ΛΑΜΠΤΗΡΕΣ ΑΛΟΓΟΝΟΥ ΣΦΑΙΡΙΚΟΙ  
G45 - E14



PRODUCTION MATERIAL: **GLASS + ALUMINIUM BASE**  
ΥΛΙΚΟ ΚΑΤΑΣΚΕΥΗΣ: **ΓΥΑΛΙ + ΒΑΣΗ ΑΛΟΥΜΙΝΙΟΥ**

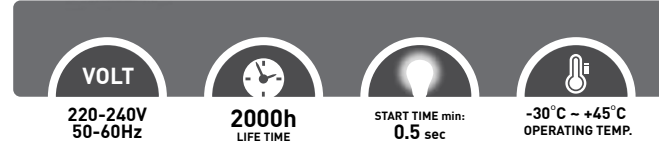
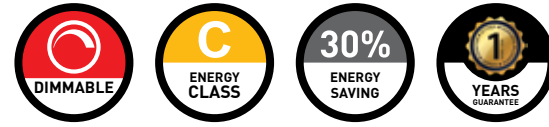

| BARCODE       | CODE       | BASE | TYPE | WATT | LUMEN | mm | mm | PACKING  | PRICE (€) |
|---------------|------------|------|------|------|-------|----|----|----------|-----------|
| 5206139096739 | 147-88429  | E14  | G45  | 18W  | 204   | 80 | 45 | 1/10/100 | 1.20      |
| 5206139007773 | 147-884300 | E14  | G45  | 28W  | 370   | 80 | 45 | 1/10/100 | 1.20      |
| 5206139000729 | 147-884310 | E14  | G45  | 42W  | 630   | 80 | 45 | 1/10/100 | 1.20      |



• HALOGEN BULBS MINI GLOBE  
• ΛΑΜΠΤΗΡΕΣ ΑΛΟΓΟΝΟΥ ΣΦΑΙΡΙΚΟΙ  
G45 - E27



PRODUCTION MATERIAL: **GLASS + ALUMINIUM BASE**  
ΥΛΙΚΟ ΚΑΤΑΣΚΕΥΗΣ: **ΓΥΑΛΙ + ΒΑΣΗ ΑΛΟΥΜΙΝΙΟΥ**

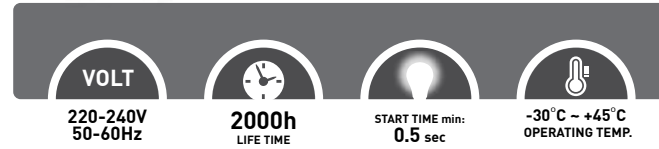
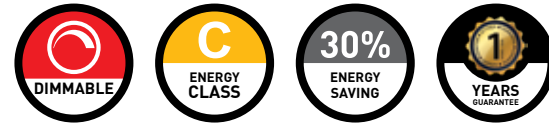

| BARCODE       | CODE       | BASE | TYPE | WATT | LUMEN | mm | mm | PACKING  | PRICE (€) |
|---------------|------------|------|------|------|-------|----|----|----------|-----------|
| 5206139096760 | 147-88434  | E27  | G45  | 18W  | 204   | 70 | 45 | 1/10/100 | 1.20      |
| 5206139014061 | 147-884350 | E27  | G45  | 28W  | 370   | 70 | 45 | 1/10/100 | 1.20      |
| 5206139014108 | 147-884360 | E27  | G45  | 42W  | 630   | 70 | 45 | 1/10/100 | 1.20      |



• HALOGEN BULBS MINI GLOBE  
• ΛΑΜΠΤΗΡΕΣ ΑΛΟΓΟΝΟΥ ΣΦΑΙΡΙΚΟΙ  
**BLISTER** • G45 - E14 / E27



PRODUCTION MATERIAL: **GLASS + ALUMINIUM BASE**  
ΥΛΙΚΟ ΚΑΤΑΣΚΕΥΗΣ: **ΓΥΑΛΙ + ΒΑΣΗ ΑΛΟΥΜΙΝΙΟΥ**

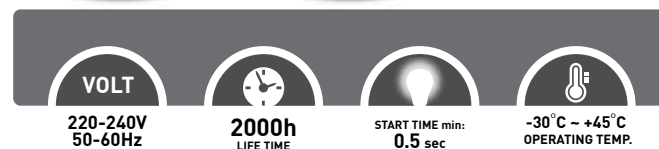
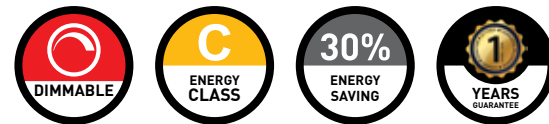

| BARCODE       | CODE       | BASE | TYPE | WATT | LUMEN | mm | mm | PACKING | PRICE (€) |
|---------------|------------|------|------|------|-------|----|----|---------|-----------|
| 5206139021236 | 800-884300 | E14  | G45  | 28W  | 370   | 80 | 45 | 1/10/60 | 1.49      |
| 5206139006646 | 800-884310 | E14  | G45  | 42W  | 630   | 80 | 45 | 1/10/60 | 1.49      |
| 5206139043443 | 800-88435  | E27  | G45  | 28W  | 370   | 70 | 45 | 1/10/60 | 1.49      |
| 5206139043450 | 800-88436  | E27  | G45  | 42W  | 630   | 70 | 45 | 1/10/60 | 1.49      |



• HALOGEN BULBS • ΛΑΜΠΤΗΡΕΣ ΑΛΟΓΟΝΟΥ  
R50 - E14



PRODUCTION MATERIAL: **GLASS + ALUMINIUM BASE**  
ΥΛΙΚΟ ΚΑΤΑΣΚΕΥΗΣ: **ΓΥΑΛΙ + ΒΑΣΗ ΑΛΟΥΜΙΝΙΟΥ**

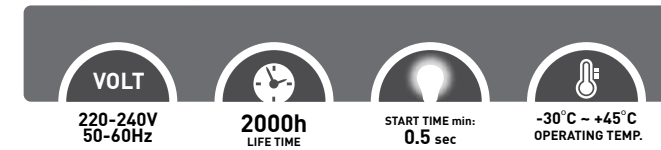
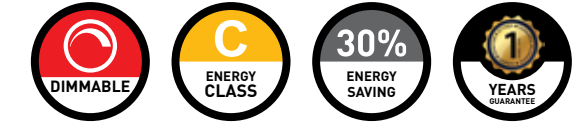

| BARCODE       | CODE       | BASE | TYPE | WATT | LUMEN | mm | mm | PACKING  | PRICE (€) |
|---------------|------------|------|------|------|-------|----|----|----------|-----------|
| 5206139007506 | 147-887500 | E14  | R50  | 28W  | 280   | 84 | 50 | 1/10/100 | 2.26      |
| 5206139014436 | 147-887530 | E14  | R50  | 42W  | 460   | 84 | 50 | 1/10/100 | 2.26      |



• HALOGEN BULBS • ΛΑΜΠΤΗΡΕΣ ΑΛΟΓΟΝΟΥ  
R63 - E27



PRODUCTION MATERIAL: **GLASS + ALUMINIUM BASE**  
ΥΛΙΚΟ ΚΑΤΑΣΚΕΥΗΣ: **ΓΥΑΛΙ + ΒΑΣΗ ΑΛΟΥΜΙΝΙΟΥ**

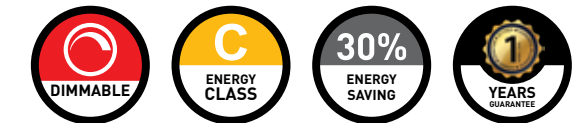

| BARCODE       | CODE       | BASE | TYPE | WATT | LUMEN | mm  | mm | PACKING  | PRICE (€) |
|---------------|------------|------|------|------|-------|-----|----|----------|-----------|
| 5206139007513 | 147-887510 | E27  | R63  | 42W  | 460   | 103 | 63 | 1/10/100 | 2.38      |
| 5206139015631 | 147-887540 | E27  | R63  | 28W  | 280   | 103 | 63 | 1/10/100 | 2.38      |



• HALOGEN BULBS • ΛΑΜΠΤΗΡΕΣ ΑΛΟΓΟΝΟΥ  
• R50 - E14 • R63 - E27  
**BLISTER**



PRODUCTION MATERIAL: **GLASS + ALUMINIUM BASE**  
ΥΛΙΚΟ ΚΑΤΑΣΚΕΥΗΣ: **ΓΥΑΛΙ + ΒΑΣΗ ΑΛΟΥΜΙΝΙΟΥ**

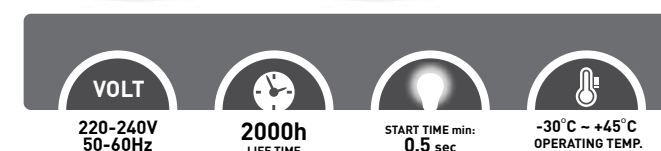
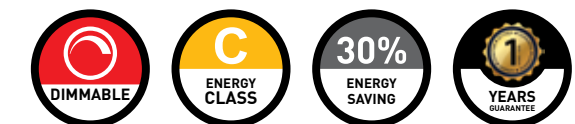

| BARCODE       | CODE       | BASE | TYPE | WATT | LUMEN | mm  | mm | PACKING | PRICE (€) |
|---------------|------------|------|------|------|-------|-----|----|---------|-----------|
| 5206139005564 | 800-887500 | E14  | R50  | 28W  | 280   | 84  | 50 | 1/10/60 | 2.38      |
| 5206139005571 | 800-887510 | E27  | R63  | 42W  | 460   | 103 | 63 | 1/10/60 | 2.47      |
| 5206139035882 | 800-88753  | E14  | R50  | 42W  | 460   | 84  | 50 | 1/10/60 | 2.96      |

- HALOGEN BULBS GLOBE
- ΛΑΜΠΤΗΡΕΣ ΑΛΟΓΟΝΟΥ ΣΦΑΙΡΙΚΟΙ  
G80 / G95 / G125 - E27

PRODUCTION MATERIAL: **GLASS + ALUMINIUM BASE**  
ΥΛΙΚΟ ΚΑΤΑΣΚΕΥΗΣ: **ΓΥΑΛΙ + ΒΑΣΗ ΑΛΟΥΜΙΝΙΟΥ**



Color  
Box  
PACKING

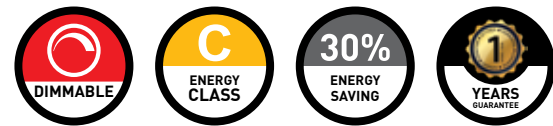
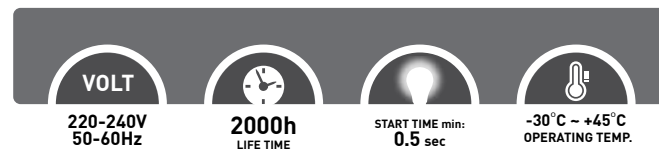

| BARCODE       | CODE       | BASE | TYPE | WATT | LUMEN | ↑ mm | ∅   | PACKING | PRICE (€) |
|---------------|------------|------|------|------|-------|------|-----|---------|-----------|
| 5206139005601 | 147-88420  | E27  | G80  | 28W  | 370   | 112  | 80  | 1/5/50  | 3.52      |
| 5206139005618 | 147-88421  | E27  | G95  | 42W  | 630   | 130  | 95  | 1/5/25  | 3.52      |
| 5206139022707 | 147-884230 | E27  | G125 | 105W | 1390  | 140  | 125 | 1/5/25  | 4.98      |

- HALOGEN BULBS • ΛΑΜΠΤΗΡΕΣ ΙΩΔΙΝΗΣ  
TUBULAR • R7s - 118mm & 78mm

PRODUCTION MATERIAL: **GLASS WITH CERAMIC BASE**  
ΥΛΙΚΟ ΚΑΤΑΣΚΕΥΗΣ: **ΓΥΑΛΙ ΜΕ ΚΕΡΑΜΙΚΗ ΒΑΣΗ**

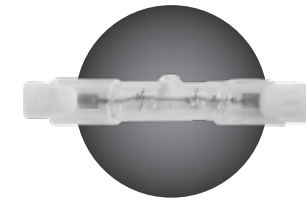
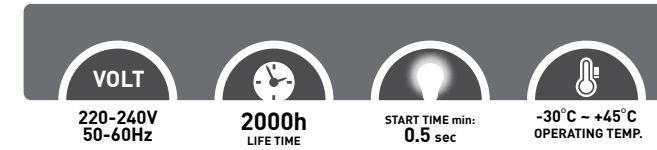

Color  
Box  
PACKING

| BARCODE       | CODE       | BASE | TYPE    | WATT | LUMEN | ↑ mm | ∅  | PACKING     | PRICE (€) |
|---------------|------------|------|---------|------|-------|------|----|-------------|-----------|
| 5206139014283 | 147-885000 | R7s  | TUBULAR | 80W  | 1380  | 78   | 10 | 1/10/50/500 | 1.90      |
| 5206139013651 | 147-885010 | R7s  | TUBULAR | 120W | 2250  | 78   | 10 | 1/10/50/500 | 1.90      |
| 5206139013668 | 147-885020 | R7s  | TUBULAR | 160W | 3100  | 78   | 10 | 1/10/50/500 | 1.90      |
| 5206139041739 | 147-885030 | R7s  | TUBULAR | 48W  | 828   | 78   | 10 | 1/10/50/500 | 1.90      |

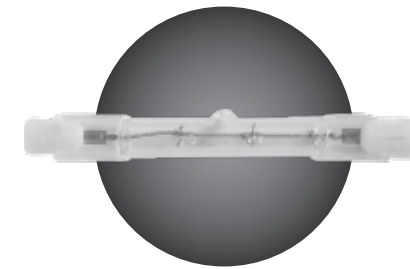

Color  
Box  
PACKING

| BARCODE       | CODE       | BASE | TYPE    | WATT | LUMEN | ↑ mm | ∅  | PACKING     | PRICE (€) |
|---------------|------------|------|---------|------|-------|------|----|-------------|-----------|
| 5206139013675 | 147-885060 | R7s  | TUBULAR | 120W | 2220  | 118  | 10 | 1/10/50/500 | 1.95      |
| 5206139013682 | 147-885070 | R7s  | TUBULAR | 160W | 3100  | 118  | 10 | 1/10/50/500 | 1.95      |
| 5206139005076 | 147-885080 | R7s  | TUBULAR | 230W | 4650  | 118  | 10 | 1/10/50/500 | 1.95      |
| 5206139013699 | 147-885090 | R7s  | TUBULAR | 400W | 8550  | 118  | 10 | 1/10/50/500 | 1.95      |

- HALOGEN BULBS • ΛΑΜΠΤΗΡΕΣ ΙΩΔΙΝΗΣ  
TUBULAR • R7s - 118mm & 78mm  
**2PCS • BLISTER**

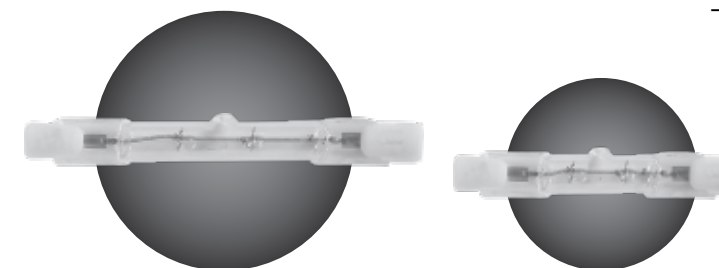

2  
PCS  
Single  
Blister  
PACKING

| BARCODE       | CODE      | BASE | TYPE    | WATT | LUMEN | ↑ mm | ∅  | PACKING  | PRICE (€) |
|---------------|-----------|------|---------|------|-------|------|----|----------|-----------|
| 5206139085627 | 800-88562 | R7s  | TUBULAR | 120W | 2250  | 78   | 10 | 1/10/100 | 3.65      |
| 5206139085672 | 800-88567 | R7s  | TUBULAR | 230W | 4650  | 118  | 10 | 1/10/100 | 3.65      |

• HALOGEN BULBS • ΛΑΜΠΤΗΡΕΣ ΑΛΟΓΟΝΟΥ  
G4



PRODUCTION MATERIAL: **GLASS + METALLIC BASE**  
ΥΛΙΚΟ ΚΑΤΑΣΚΕΥΗΣ: ΓΥΑΛΙ + ΜΕΤΑΛΛΙΚΗ ΒΑΣΗ

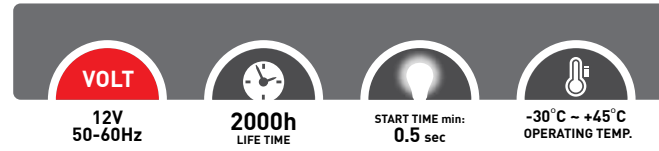
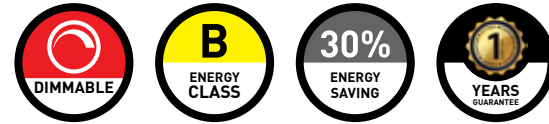

| BARCODE       | CODE       | BASE | TYPE | WATT | LUMEN | ↑ mm | ∅ | PACKING   | PRICE (€) |
|---------------|------------|------|------|------|-------|------|---|-----------|-----------|
| 5206139013705 | 147-885310 | G4   | G4   | 7W   | 100   | 32   | 9 | 1/50/1000 | 0.62      |
| 5206139013712 | 147-885320 | G4   | G4   | 14W  | 260   | 32   | 9 | 1/50/1000 | 0.62      |



| BARCODE       | CODE       | BASE | TYPE | WATT | LUMEN | ↑ mm | ∅ | PACKING  | PRICE (€) |
|---------------|------------|------|------|------|-------|------|---|----------|-----------|
| 5206139007629 | 800-885210 | G4   | G4   | 14W  | 260   | 32   | 9 | 1/10/100 | 1.25      |

• HALOGEN BULBS • ΛΑΜΠΤΗΡΕΣ ΑΛΟΓΟΝΟΥ  
G9

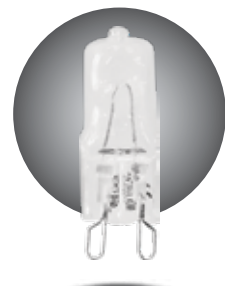

PRODUCTION MATERIAL: **GLASS + METALLIC BASE**  
ΥΛΙΚΟ ΚΑΤΑΣΚΕΥΗΣ: ΓΥΑΛΙ + ΜΕΤΑΛΛΙΚΗ ΒΑΣΗ

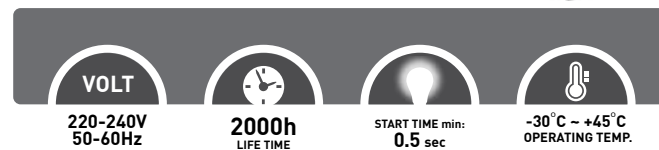

| BARCODE       | CODE       | BASE | TYPE | WATT | LUMEN | ↑ mm | ∅  | PACKING    | PRICE (€) |
|---------------|------------|------|------|------|-------|------|----|------------|-----------|
| 5206139013736 | 147-885360 | G9   | G9   | 28W  | 370   | 40   | 15 | 1/100/1000 | 0.98      |
| 5206139013743 | 147-885370 | G9   | G9   | 33W  | 460   | 40   | 15 | 1/100/1000 | 0.98      |
| 5206139013750 | 147-885380 | G9   | G9   | 42W  | 630   | 40   | 15 | 1/100/1000 | 0.98      |



| BARCODE       | CODE       | BASE | TYPE | WATT | LUMEN | ↑ mm | ∅  | PACKING  | PRICE (€) |
|---------------|------------|------|------|------|-------|------|----|----------|-----------|
| 5206139039972 | 800-885310 | G9   | G9   | 33W  | 460   | 40   | 15 | 1/10/100 | 2.25      |

• HALOGEN BULBS CLOSED  
• ΛΑΜΠΤΗΡΕΣ ΑΛΟΓΟΝΟΥ ΚΛΕΙΣΤΗ  
12V • MR16 - GU 5.3



PRODUCTION MATERIAL: **GLASS + METALLIC BASE**  
ΥΛΙΚΟ ΚΑΤΑΣΚΕΥΗΣ: ΓΥΑΛΙ + ΜΕΤΑΛΛΙΚΗ ΒΑΣΗ

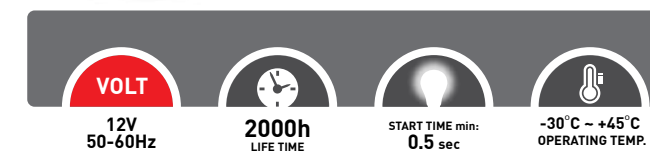
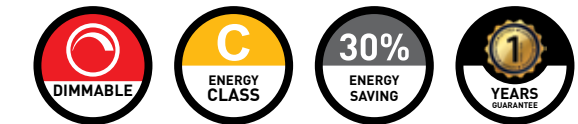

| BARCODE       | CODE       | BASE   | TYPE | WATT | LUMEN | ↑ mm | ∅  | PACKING  | PRICE (€) |
|---------------|------------|--------|------|------|-------|------|----|----------|-----------|
| 5206139013767 | 147-888300 | GU 5.3 | MR16 | 28W  | 370   | 45   | 50 | 1/10/200 | 1.36      |
| 5206139013781 | 147-888310 | GU 5.3 | MR16 | 33W  | 460   | 45   | 50 | 1/10/200 | 1.36      |
| 5206139013774 | 147-888320 | GU 5.3 | MR16 | 42W  | 630   | 45   | 50 | 1/10/200 | 1.36      |

• HALOGEN BULBS CLOSED  
• ΛΑΜΠΤΗΡΕΣ ΑΛΟΓΟΝΟΥ ΚΛΕΙΣΤΗ  
MR16 - GU 5.3



PRODUCTION MATERIAL: **GLASS + METALLIC BASE**  
ΥΛΙΚΟ ΚΑΤΑΣΚΕΥΗΣ: ΓΥΑΛΙ + ΜΕΤΑΛΛΙΚΗ ΒΑΣΗ

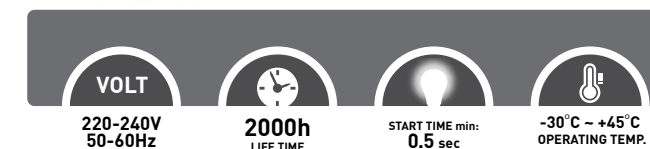
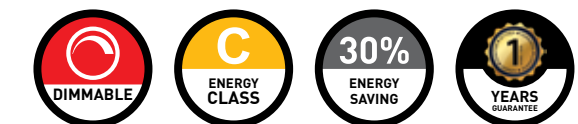

| BARCODE       | CODE       | BASE   | TYPE | WATT | LUMEN | ↑ mm | ∅  | PACKING  | PRICE (€) |
|---------------|------------|--------|------|------|-------|------|----|----------|-----------|
| 5206139013798 | 147-888330 | GU 5.3 | MR16 | 28W  | 370   | 45   | 50 | 1/10/200 | 1.36      |
| 5206139013804 | 147-888340 | GU 5.3 | MR16 | 33W  | 460   | 45   | 50 | 1/10/200 | 1.36      |
| 5206139013811 | 147-888350 | GU 5.3 | MR16 | 42W  | 630   | 45   | 50 | 1/10/200 | 1.36      |



| BARCODE       | CODE       | BASE   | TYPE | WATT | LUMEN | ↑ mm | ∅  | PACKING  | PRICE (€) |
|---------------|------------|--------|------|------|-------|------|----|----------|-----------|
| 5206139007711 | 800-888210 | GU 5.3 | MR16 | 33W  | 460   | 45   | 50 | 1/10/100 | 3.05      |

• HALOGEN BULBS  
• ΛΑΜΠΤΗΡΕΣ ΑΛΟΓΟΝΟΥ  
**12V • MR11 - GU4**



PRODUCTION MATERIAL: **GLASS + METALLIC BASE**  
ΥΛΙΚΟ ΚΑΤΑΣΚΕΥΗΣ: **ΓΥΑΛΙ + ΜΕΤΑΛΛΙΚΗ ΒΑΣΗ**

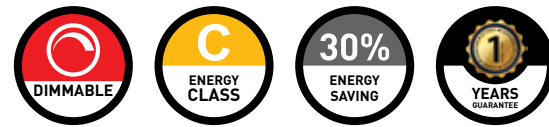
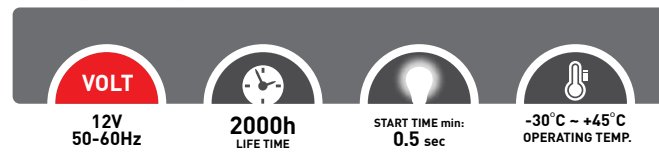

| BARCODE       | CODE       | BASE | TYPE | WATT | LUMEN | mm | mm | PACKING  | PRICE (€) |
|---------------|------------|------|------|------|-------|----|----|----------|-----------|
| 5206139020161 | 147-888280 | GU4  | MR11 | 18W  | 210   | 35 | 35 | 1/10/200 | 1.36      |
| 5206139020192 | 147-888290 | GU4  | MR11 | 28W  | 370   | 35 | 35 | 1/10/200 | 1.36      |

• HALOGEN BULBS  
• ΛΑΜΠΤΗΡΕΣ ΑΛΟΓΟΝΟΥ  
**MR16 - GU10**



PRODUCTION MATERIAL: **GLASS WITH CERAMIC BASE**  
ΥΛΙΚΟ ΚΑΤΑΣΚΕΥΗΣ: **ΓΥΑΛΙ ΜΕ ΚΕΡΑΜΙΚΗ ΒΑΣΗ**

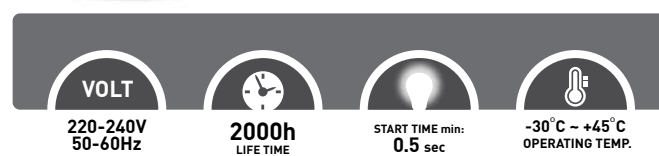

| BARCODE       | CODE       | BASE | TYPE | WATT | LUMEN | mm | mm | PACKING  | PRICE (€) |
|---------------|------------|------|------|------|-------|----|----|----------|-----------|
| 5206139013828 | 147-888360 | GU10 | MR16 | 28W  | 370   | 50 | 50 | 1/10/200 | 1.72      |
| 5206139013835 | 147-888370 | GU10 | MR16 | 33W  | 460   | 50 | 50 | 1/10/200 | 1.72      |
| 5206139013842 | 147-888380 | GU10 | MR16 | 42W  | 630   | 50 | 50 | 1/10/200 | 1.72      |



| BARCODE       | CODE       | BASE | TYPE | WATT | LUMEN | mm | mm | PACKING  | PRICE (€) |
|---------------|------------|------|------|------|-------|----|----|----------|-----------|
| 5206139007742 | 800-888310 | GU10 | MR16 | 33W  | 460   | 50 | 50 | 1/10/100 | 3.40      |



## FLUORESCENT Lamps

106



TYPE: T8 / BASE: G13

TYPE: T5 / BASE: G5

TYPE: T9 / BASE: G10J

TYPE: PL-C / BASE: G24d-2

Type: T5 / T8 / T9 / PL-C

Discover our Collection ►

107

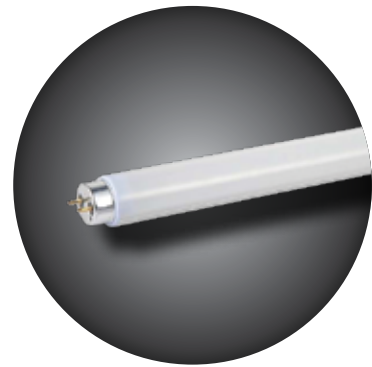

• FLUORESCENT TUBE TRI-PHOSPHOR BULBS  
• ΛΑΜΠΤΗΡΕΣ ΦΘΟΡΙΟΥ  
T8 - G13 • T5 - G5

PRODUCTION MATERIAL: **GLASS + METALLIC BASE**  
ΥΛΙΚΟ ΚΑΤΑΣΚΕΥΗΣ: **ΓΥΑΛΙ + ΜΕΤΑΛΛΙΚΗ ΒΑΣΗ**

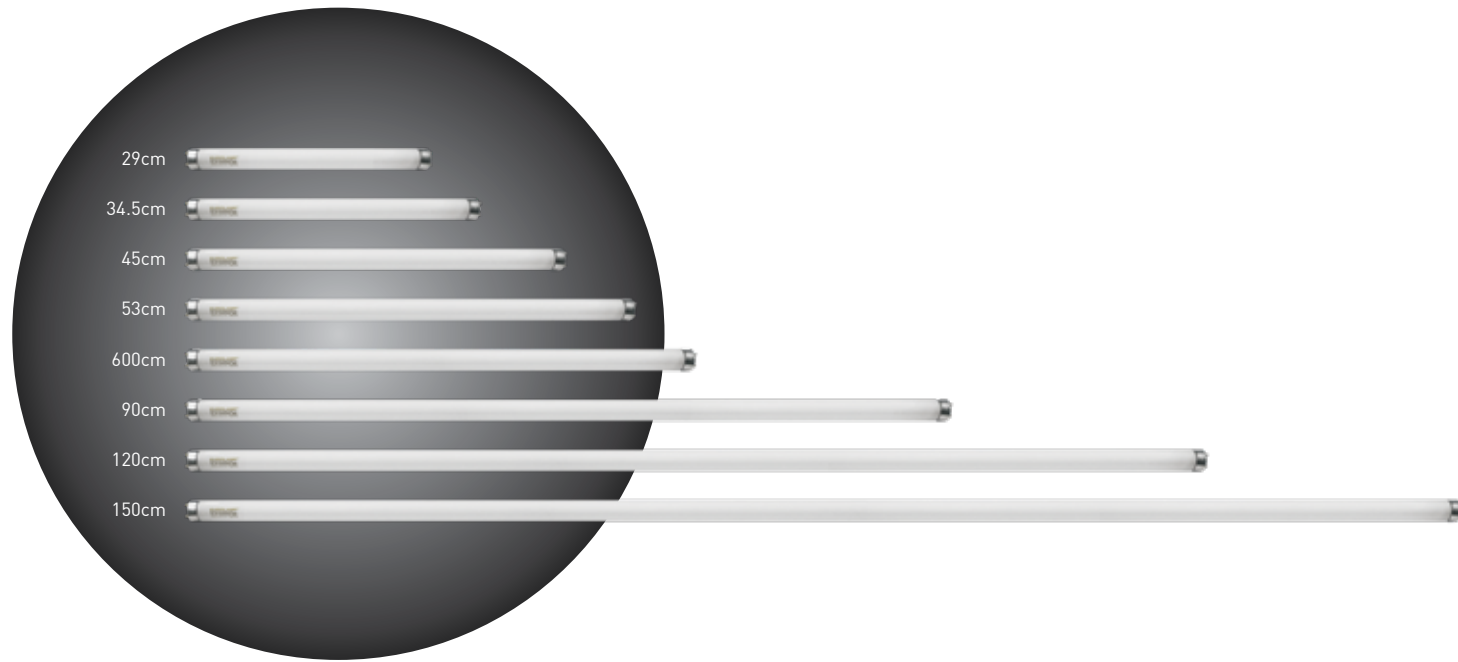

| BARCODE       | CODE      | BASE | TYPE | WATT | KELVIN | LUMEN | ↑ mm | ∅  | PACKING | PRICE (€) |
|---------------|-----------|------|------|------|--------|-------|------|----|---------|-----------|
| 5206139011299 | 147-88624 | G13  | T8   | 30W  | 6500K  | 2025  | 900  | 26 | 1/25    | 1.85      |
| 5206139011381 | 147-88625 | G13  | T8   | 18W  | 6500K  | 960   | 600  | 26 | 1/25    | 1.60      |
| 5206139011398 | 147-88626 | G13  | T8   | 36W  | 6500K  | 2650  | 1200 | 26 | 1/25    | 1.90      |
| 5206139011435 | 147-88627 | G13  | T8   | 58W  | 6500K  | 4270  | 1500 | 26 | 1/25    | 3.85      |
| 5206139011404 | 147-88640 | G13  | T8   | 18W  | 4000K  | 960   | 600  | 26 | 1/25    | 1.60      |
| 5206139011411 | 147-88641 | G13  | T8   | 36W  | 4000K  | 2650  | 1200 | 26 | 1/25    | 1.90      |
| 5206139011428 | 147-88642 | G13  | T8   | 58W  | 4000K  | 4270  | 1500 | 26 | 1/25    | 3.85      |

| BARCODE       | CODE      | BASE | TYPE | WATT | KELVIN | LUMEN | ↑ mm | ∅  | PACKING | PRICE (€) |
|---------------|-----------|------|------|------|--------|-------|------|----|---------|-----------|
| 5206139011978 | 147-88608 | G13  | T8   | 10W  | 6500K  | 390   | 345  | 26 | 1/25    | 1.50      |
| 5206139011251 | 147-88610 | G13  | T8   | 15W  | 6500K  | 610   | 450  | 26 | 1/25    | 1.85      |

| BARCODE       | CODE      | BASE | TYPE | WATT | KELVIN | LUMEN | ↑ mm | ∅  | PACKING  | PRICE (€) |
|---------------|-----------|------|------|------|--------|-------|------|----|----------|-----------|
| 5206139011954 | 147-88607 | G5   | T5   | 8W   | 6500K  | 360   | 290  | 16 | 1/10/200 | 1.85      |
| 5206139011961 | 147-88609 | G5   | T5   | 13W  | 6500K  | 800   | 530  | 16 | 1/10/200 | 2.00      |

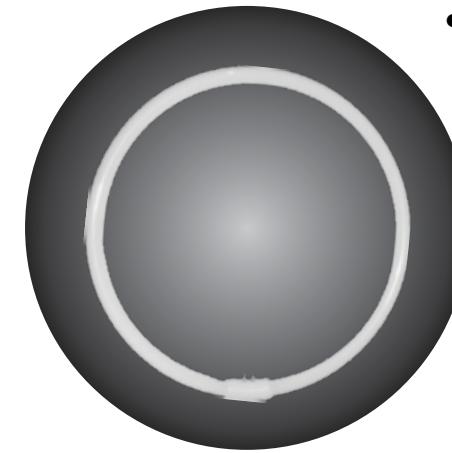

• FLUORESCENT ROUNDED TRI-PHOSPHOR BULB  
• ΛΑΜΠΤΗΡΑΣ ΦΘΟΡΙΟΥ ΚΥΚΛΙΚΟΣ  
T9 - G10Q

PRODUCTION MATERIAL: **GLASS WITH METALLIC BASE**  
ΥΛΙΚΟ ΚΑΤΑΣΚΕΥΗΣ: **ΓΥΑΛΙ ΜΕ ΜΕΤΑΛΛΙΚΗ ΒΑΣΗ**

Color  
Box  
PACKING



| BARCODE       | CODE      | BASE | TYPE | WATT       | KELVIN | LUMEN        | ↑ mm       | ∅  | PACKING | PRICE (€) |
|---------------|-----------|------|------|------------|--------|--------------|------------|----|---------|-----------|
| 5206139011442 | 147-88635 | G10Q | T9   | 22W        | 6500K  | 1500         | 209        | 30 | 1/20    | 3.70      |
| 5206139011480 | 147-88636 | G10Q | T9   | 32W        | 6500K  | 2250         | 300        | 30 | 1/20    | 3.85      |
| 5206139011497 | 147-88637 | G10Q | T9   | 40W        | 6500K  | 2800         | 400        | 30 | 1/20    | 6.00      |
| 5206139011503 | 147-88638 | G10Q | T9   | 32W<br>40W | 6500K  | 2250<br>2800 | 300<br>400 | 30 | 1/20    | 9.20      |



• FLUORESCENT BULB • ΛΑΜΠΤΗΡΑΣ ΦΘΟΡΙΟΥ  
PL-C • G24d-2 / G24d-3

PRODUCTION MATERIAL: **GLASS WITH METALLIC BASE**  
ΥΛΙΚΟ ΚΑΤΑΣΚΕΥΗΣ: **ΓΥΑΛΙ ΜΕ ΜΕΤΑΛΛΙΚΗ ΒΑΣΗ**

Color  
Box  
PACKING



| BARCODE       | CODE      | BASE   | TYPE | WATT | KELVIN | LUMEN | ↑ mm | ∅  | PACKING  | PRICE (€) |
|---------------|-----------|--------|------|------|--------|-------|------|----|----------|-----------|
| 5206139012241 | 147-88924 | G24d-2 | PL-C | 18W  | 4000K  | 1160  | 150  | 35 | 1/10/100 | 2.95      |
| 5206139012081 | 147-88925 | G24d-3 | PL-C | 26W  | 4000K  | 1560  | 170  | 35 | 1/10/100 | 2.95      |



Color  
Box  
PACKING



• STARTERS / S2 - S10

PRODUCTION MATERIAL: **PLASTIC**  
ΥΛΙΚΟ ΚΑΤΑΣΚΕΥΗΣ: **ΠΛΑΣΤΙΚΟ**

| BARCODE       | CODE      | TYPE | WATT     | ↑ mm | ∅  | PACKING  | PRICE (€) |
|---------------|-----------|------|----------|------|----|----------|-----------|
| 5206139062444 | 147-02202 | S2   | 4 - 22 W | 40   | 20 | 1/25/500 | 0.38      |
| 5206139062567 | 147-02203 | S10  | 4 - 65 W | 40   | 20 | 1/25/500 | 0.38      |

TYPE: SOD-EI / PEAR SHAPED / E27-E40



TYPE: PEAR SHAPED / E27-E40



TYPE: TUBULAR / SOD-T / E27-E40



TYPE: TUBULAR / UV STOP QUARTZ / E40



TYPE: Rx7s / UV STOP QUARTZ / E40



TYPE: G12



Type: Pear Shaped / TUBULAR / Rx7s / G12

HIGH PRESSURE / METAL HALIDE Lamps

Discover our Collection ►



- SODIUM BULB COATED WITH IGNITOR
- ΛΑΜΠΤΗΡΑΣ ΝΑΤΡΙΟΥ ΜΕ ΕΚΚΙΝΗΤΗ SOD-E/I • PEAR SHAPED / E27 - E40

PRODUCTION MATERIAL: **GLASS + ALUMINIUM BASE**  
ΥΛΙΚΟ ΚΑΤΑΣΚΕΥΗΣ: **ΓΥΑΛΙ + ΒΑΣΗ ΑΛΟΥΜΙΝΙΟΥ**

Color  
Box  
PACKING

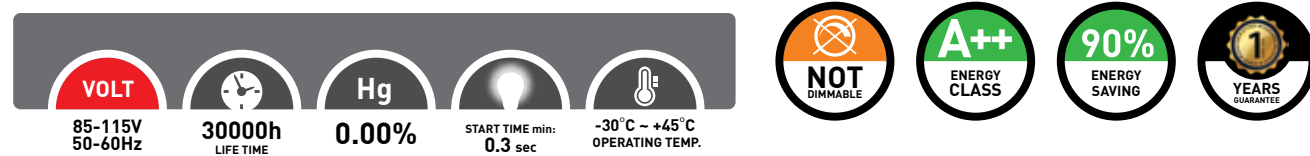

| BARCODE       | CODE      | BASE | TYPE    | WATT | KELVIN | LUMENS | Lm/W | mm  | PACKING | PRICE (€) |
|---------------|-----------|------|---------|------|--------|--------|------|-----|---------|-----------|
| 5206139007926 | 147-86010 | E27  | SOD-E/I | 70W  | 2050K  | 5880   | 84   | 165 | 75 1/40 | 17.50     |
| 5206139007964 | 147-86012 | E27  | SOD-E/I | 110W | 2050K  | 9020   | 82   | 165 | 75 1/40 | 17.90     |
| 5206139013859 | 147-86014 | E40  | SOD-E/I | 210W | 2050K  | 24150  | 115  | 228 | 90 1/12 | 19.50     |

### ΦΩΤΟΜΕΤΡΙΚΑ / PHOTOMETRY

ΦΑΣΜΑΤΙΚΗ ΚΑΤΑΝΟΜΗ  
SPECTRAL DISTRIBUTION

ΧΡΩΜΑΤΙΚΟ ΔΙΑΓΡΑΜΜΑ  
COLOR DIAGRAM

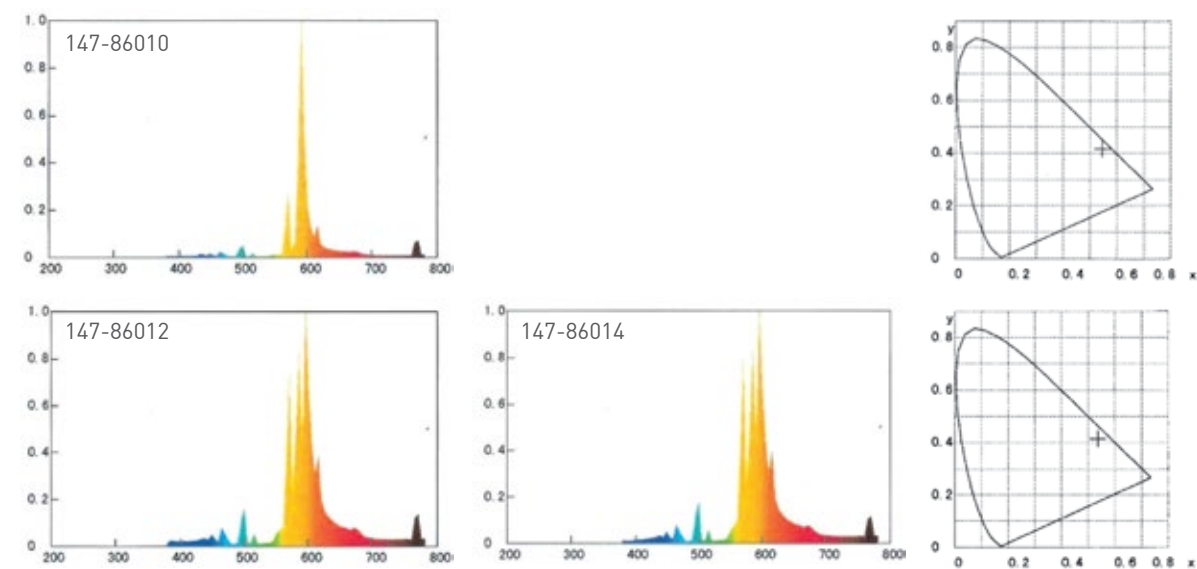

- SODIUM BULB COATED
- ΛΑΜΠΤΗΡΑΣ ΝΑΤΡΙΟΥ SOD-E/D • PEAR SHAPED / E27 - E40

PRODUCTION MATERIAL: **GLASS + ALUMINIUM BASE**  
ΥΛΙΚΟ ΚΑΤΑΣΚΕΥΗΣ: **ΓΥΑΛΙ + ΒΑΣΗ ΑΛΟΥΜΙΝΙΟΥ**

Color  
Box  
PACKING

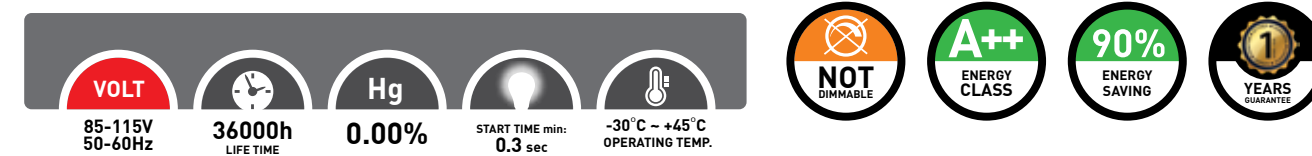

| BARCODE       | CODE      | BASE | TYPE    | WATT | KELVIN | LUMENS | Lm/W | mm  | PACKING | PRICE (€) |
|---------------|-----------|------|---------|------|--------|--------|------|-----|---------|-----------|
| 5206139007940 | 147-86011 | E27  | SOD-E/D | 70W  | 2050K  | 6230   | 89   | 145 | 54 1/40 | 13.65     |
| 5206139007988 | 147-86013 | E40  | SOD-E/D | 150W | 2050K  | 17100  | 114  | 185 | 76 1/12 | 14.90     |
| 5206139013323 | 147-86015 | E40  | SOD-E/D | 250W | 2050K  | 31000  | 124  | 228 | 90 1/12 | 15.20     |
| 5206139013330 | 147-86016 | E40  | SOD-E/D | 400W | 2050K  | 54000  | 135  | 235 | 90 1/12 | 17.50     |

### ΦΩΤΟΜΕΤΡΙΚΑ / PHOTOMETRY

ΦΑΣΜΑΤΙΚΗ ΚΑΤΑΝΟΜΗ  
SPECTRAL DISTRIBUTION

ΧΡΩΜΑΤΙΚΟ ΔΙΑΓΡΑΜΜΑ  
COLOR DIAGRAM

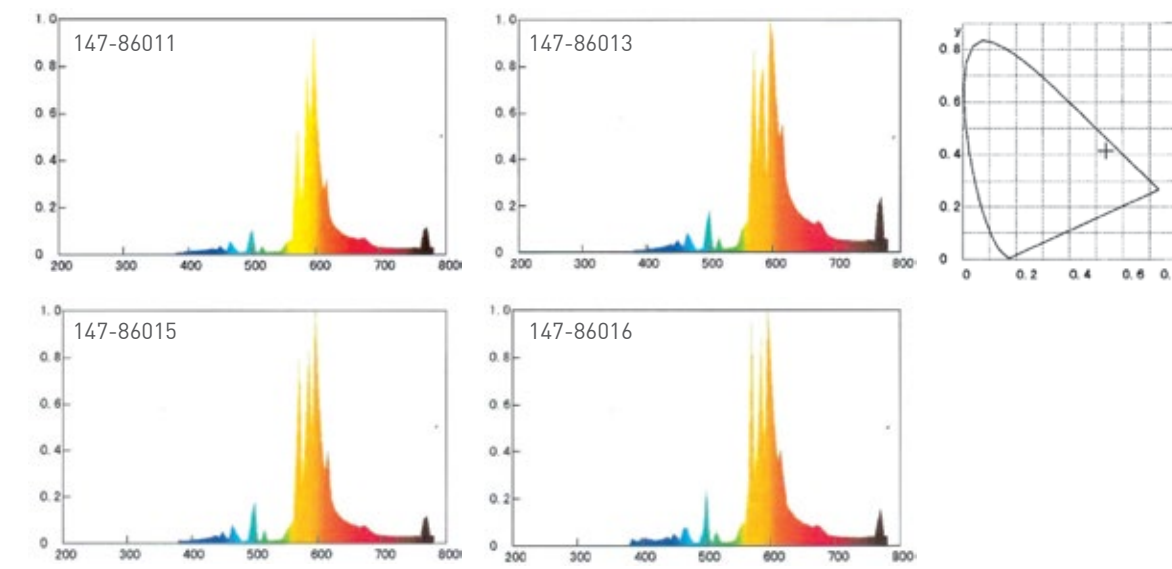



• SODIUM BULB • ΛΑΜΠΤΗΡΑΣ ΝΑΤΡΙΟΥ  
TUBULAR SOD-T • E27 - E40

PRODUCTION MATERIAL: **GLASS + ALUMINIUM BASE**  
ΥΛΙΚΟ ΚΑΤΑΣΚΕΥΗΣ: **ΓΥΑΛΙ + ΒΑΣΗ ΑΛΟΥΜΙΝΙΟΥ**

Color  
Box  
PACKING



85-115V 50-60Hz  
36000h LIFE TIME  
0.00%  
START TIME min: 0.3 sec  
-30°C ~ +45°C OPERATING TEMP.

NOT DIMMABLE  
A++ ENERGY CLASS  
90% ENERGY SAVING  
1 YEARS GUARANTEE

| BARCODE       | CODE      | BASE | TYPE    | WATT | KELVIN | LUMENS | Lm/W | mm  | PACKING | PRICE (€) |
|---------------|-----------|------|---------|------|--------|--------|------|-----|---------|-----------|
| 5206139008015 | 147-86020 | E27  | TUBULAR | 70W  | 2050K  | 6790   | 97   | 156 | 38 1/12 | 12.30     |
| 5206139013866 | 147-86021 | E40  | TUBULAR | 100W | 2050K  | 11000  | 110  | 210 | 46 1/12 | 12.50     |
| 5206139001832 | 147-86022 | E40  | TUBULAR | 150W | 2050K  | 18000  | 120  | 210 | 46 1/12 | 13.90     |
| 5206139001849 | 147-86023 | E40  | TUBULAR | 250W | 2050K  | 34000  | 136  | 260 | 46 1/12 | 14.90     |
| 5206139001856 | 147-86024 | E40  | TUBULAR | 400W | 2050K  | 57200  | 143  | 285 | 46 1/12 | 16.30     |

ΦΩΤΟΜΕΤΡΙΚΑ / PHOTOMETRY

ΦΑΣΜΑΤΙΚΗ ΚΑΤΑΝΟΜΗ  
SPECTRAL DISTRIBUTION

ΧΡΩΜΑΤΙΚΟ ΔΙΑΓΡΑΜΜΑ  
COLOR DIAGRAM

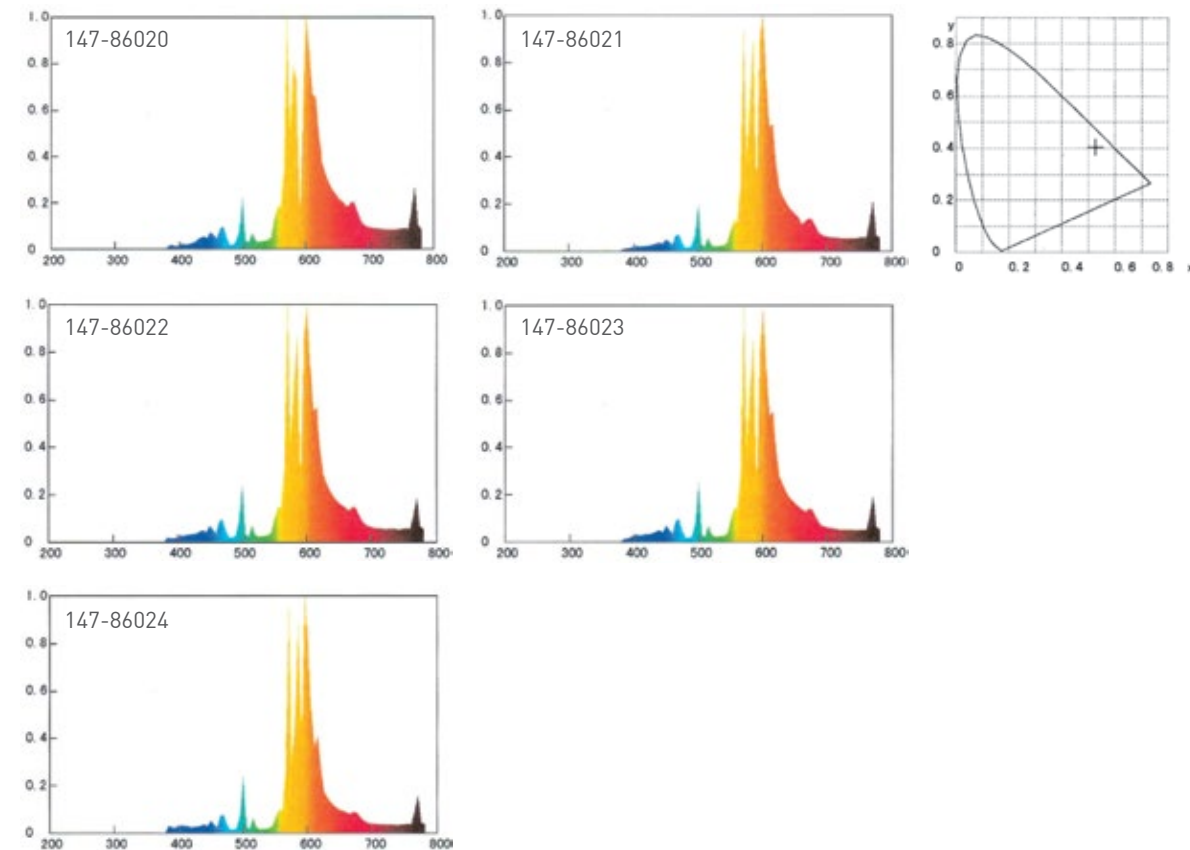

• METAL HALIDE LAMP  
• ΛΑΜΠΑ ΜΕΤΑΛΛΟΥ ΚΕΡΑΜΙΚΟΥ ΚΑΥΣΤΗΡΑ  
G12

PRODUCTION MATERIAL: **GLASS + CERAMIC BASE**  
ΥΛΙΚΟ ΚΑΤΑΣΚΕΥΗΣ: **ΓΥΑΛΙ + ΚΕΡΑΜΙΚΗ ΒΑΣΗ**

Color  
Box  
PACKING



80V 50-60Hz  
15000h LIFE TIME  
0.00%  
START TIME min: 0.3 sec  
-30°C ~ +45°C OPERATING TEMP.

NOT DIMMABLE  
A++ ENERGY CLASS  
90% ENERGY SAVING  
1 YEARS GUARANTEE

| BARCODE       | CODE      | BASE | TYPE | WATT | KELVIN | LUMEN | Lm/W | mm       | PACKING  | PRICE (€) |
|---------------|-----------|------|------|------|--------|-------|------|----------|----------|-----------|
| 5206139019349 | 147-86103 | G12  | G12  | 70W  | 6400K  | 6720  | 96   | 90 22.5  | 1/10/100 | 14.70     |
| 5206139019356 | 147-86104 | G12  | G12  | 70W  | 4200K  | 6720  | 96   | 90 22.5  | 1/10/100 | 14.70     |
| 5206139017024 | 147-86105 | G12  | G12  | 70W  | 3000K  | 6720  | 96   | 90 22.5  | 1/10/100 | 14.70     |
| 5206139014337 | 147-86106 | G12  | G12  | 150W | 6400K  | 13500 | 90   | 100 22.5 | 1/10/100 | 14.70     |
| 5206139014344 | 147-86107 | G12  | G12  | 150W | 4200K  | 13500 | 90   | 100 22.5 | 1/10/100 | 14.70     |
| 5206139014382 | 147-86108 | G12  | G12  | 150W | 3000K  | 13500 | 90   | 100 22.5 | 1/10/100 | 14.70     |

ΦΩΤΟΜΕΤΡΙΚΑ / PHOTOMETRY

ΦΑΣΜΑΤΙΚΗ ΚΑΤΑΝΟΜΗ  
SPECTRAL DISTRIBUTION

ΧΡΩΜΑΤΙΚΟ ΔΙΑΓΡΑΜΜΑ  
COLOR DIAGRAM

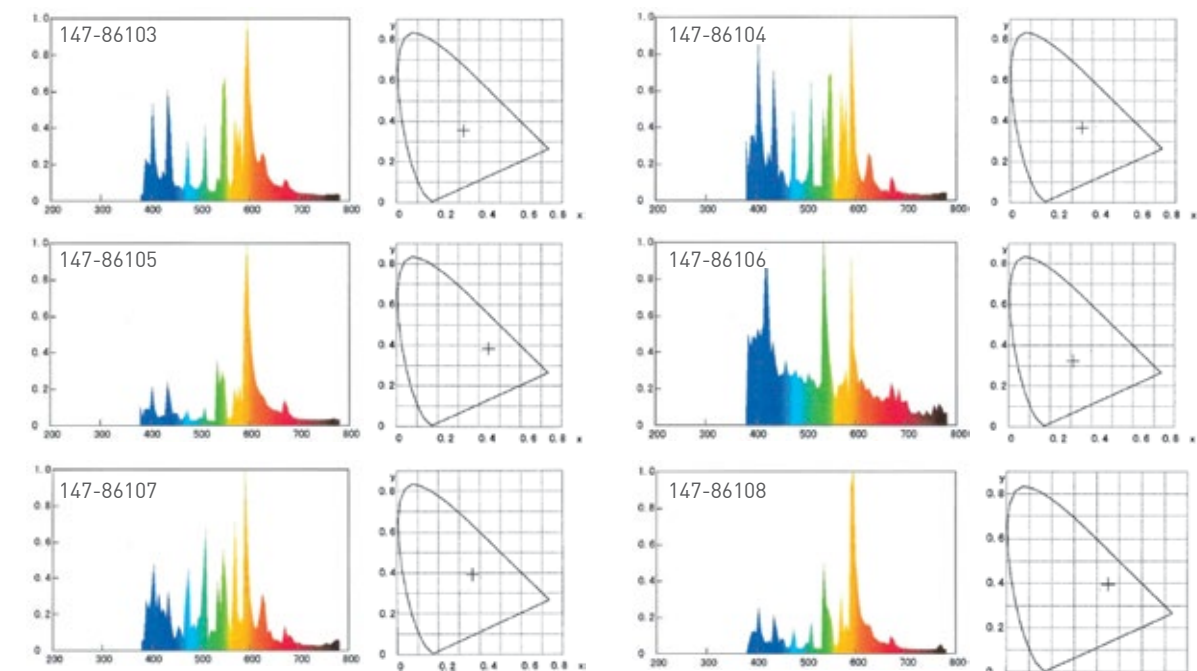

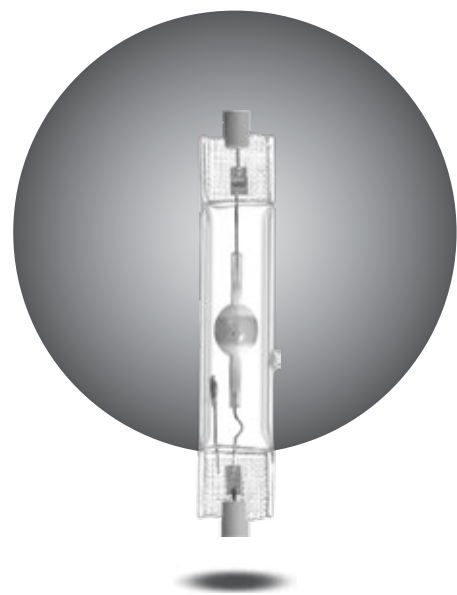

- METAL HALIDE LAMP • ΛΑΜΠΑ ΜΕΤΑΛΛΟΥ
- RX7S • UV STOP QUARTZ

PRODUCTION MATERIAL: **GLASS + CERAMIC BASE**  
 ΥΛΙΚΟ ΚΑΤΑΣΚΕΥΗΣ: **ΓΥΑΛΙ + ΚΕΡΑΜΙΚΗ ΒΑΣΗ**

Color  
Box  
PACKING



80V 50-60Hz | 15000h LIFE TIME | Hg 0.00% | START TIME min: 0.3 sec | -30°C ~ +45°C OPERATING TEMP.

NOT DIMMABLE | A++ ENERGY CLASS | 90% ENERGY SAVING | 1 YEARS GUARANTEE

| BARCODE       | CODE      | BASE | TYPE | WATT | KELVIN | LUMEN | Lm/W | mm  | mm   | PACKING  | PRICE (€) |
|---------------|-----------|------|------|------|--------|-------|------|-----|------|----------|-----------|
| 5206139013095 | 147-86110 | Rx7s | Rx7s | 70W  | 6400K  | 6790  | 97   | 117 | 20   | 1/10/100 | 12.90     |
| 5206139008077 | 147-86111 | Rx7s | Rx7s | 70W  | 4200K  | 6790  | 97   | 117 | 20   | 1/10/100 | 12.90     |
| 5206139013880 | 147-86112 | Rx7s | Rx7s | 70W  | 3000K  | 6790  | 97   | 117 | 20   | 1/10/100 | 12.90     |
| 5206139008114 | 147-86113 | Rx7s | Rx7s | 150W | 6400K  | 14250 | 95   | 136 | 22.5 | 1/10/100 | 12.90     |
| 5206139008145 | 147-86114 | Rx7s | Rx7s | 150W | 4200K  | 14250 | 95   | 136 | 22.5 | 1/10/100 | 12.90     |
| 5206139013897 | 147-86115 | Rx7s | Rx7s | 150W | 3000K  | 14250 | 95   | 136 | 22.5 | 1/10/100 | 12.90     |



- METAL HALIDE LAMP • ΛΑΜΠΑ ΜΕΤΑΛΛΟΥ
- TUBULAR • UV STOP QUARTZ
- E40

PRODUCTION MATERIAL: **GLASS WITH METALLIC BASE**  
 ΥΛΙΚΟ ΚΑΤΑΣΚΕΥΗΣ: **ΓΥΑΛΙ ΜΕ ΜΕΤΑΛΛΙΚΗ ΒΑΣΗ**

Color  
Box  
PACKING



80V 50-60Hz | 20000h LIFE TIME | Hg 0.00% | START TIME min: 0.3 sec | -30°C ~ +45°C OPERATING TEMP.

NOT DIMMABLE | A++ ENERGY CLASS | 90% ENERGY SAVING | 1 YEARS GUARANTEE

\*14000h LIFE TIME

| BARCODE       | CODE       | BASE | TYPE    | WATT  | KELVIN | LUMEN  | Lm/W | mm  | mm | PACKING | PRICE (€) |
|---------------|------------|------|---------|-------|--------|--------|------|-----|----|---------|-----------|
| 5206139013132 | 147-86120  | E40  | TUBULAR | 250W  | 6400K  | 22000  | 88   | 242 | 46 | 1/12    | 17.50     |
| 5206139013903 | 147-86121  | E40  | TUBULAR | 250W  | 4000K  | 22000  | 88   | 242 | 46 | 1/12    | 17.50     |
| 5206139005946 | 147-86122  | E40  | TUBULAR | 400W  | 6400K  | 40400  | 101  | 280 | 62 | 1/12    | 18.90     |
| 5206139005984 | 147-86123  | E40  | TUBULAR | 400W  | 4000K  | 40400  | 101  | 280 | 62 | 1/12    | 18.90     |
| 5206139013910 | 147-86125* | E40  | TUBULAR | 1000W | 7000K  | 100000 | 100  | 385 | 65 | 1/12    | 74.50     |
| 5206139008183 | 147-86126* | E40  | TUBULAR | 1000W | 4200K  | 100000 | 100  | 385 | 65 | 1/12    | 74.50     |

### ΦΩΤΟΜΕΤΡΙΚΑ / PHOTOMETRY

ΦΑΣΜΑΤΙΚΗ ΚΑΤΑΝΟΜΗ  
SPECTRAL DISTRIBUTION

ΧΡΩΜΑΤΙΚΟ ΔΙΑΓΡΑΜΜΑ  
COLOR DIAGRAM

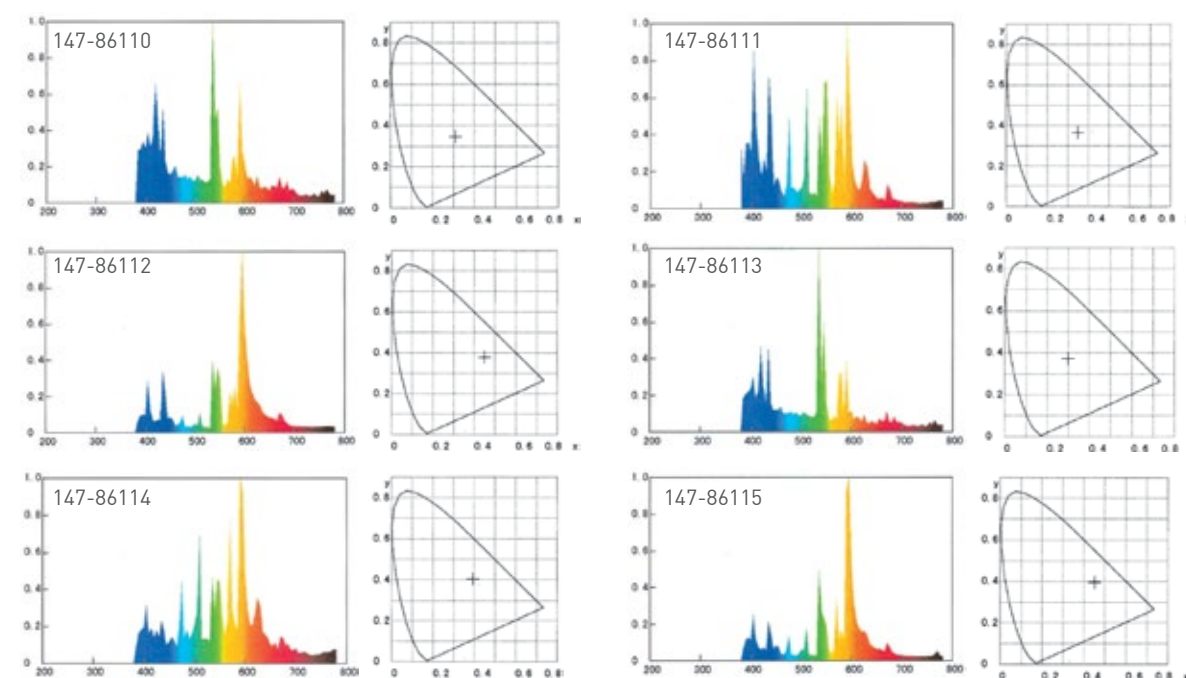

### ΦΩΤΟΜΕΤΡΙΚΑ / PHOTOMETRY

ΦΑΣΜΑΤΙΚΗ ΚΑΤΑΝΟΜΗ  
SPECTRAL DISTRIBUTION

ΧΡΩΜΑΤΙΚΟ ΔΙΑΓΡΑΜΜΑ  
COLOR DIAGRAM

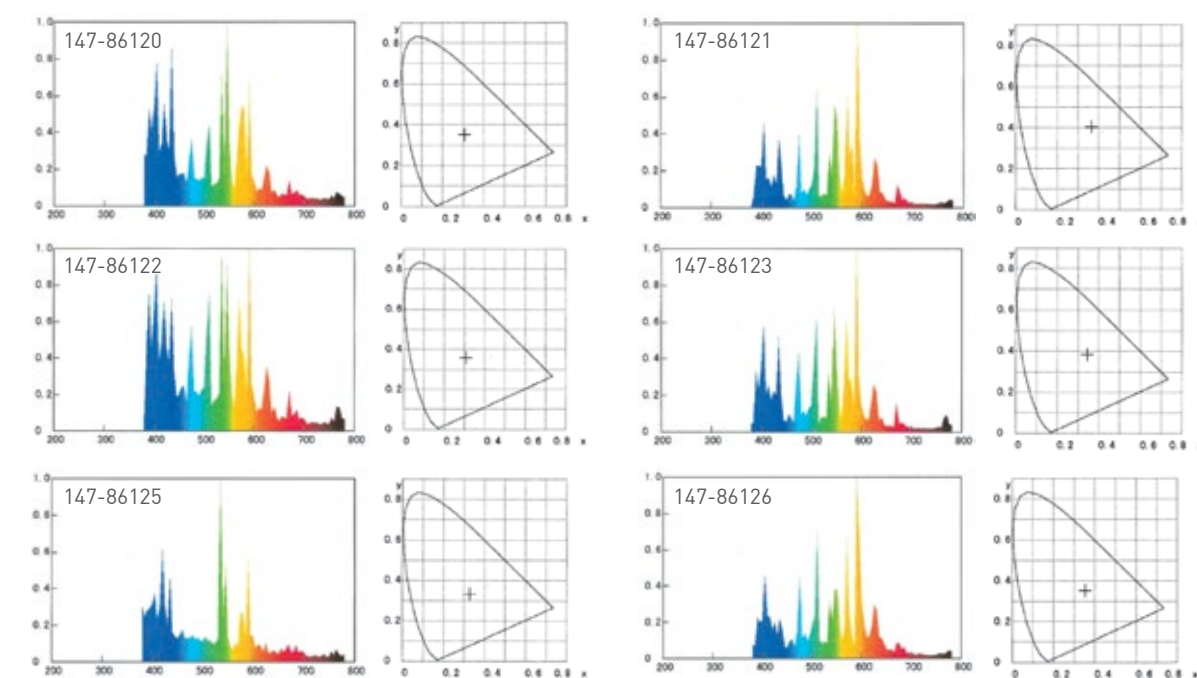



- METAL HALIDE LAMP • ΛΑΜΠΑ ΜΕΤΑΛΛΟΥ
- PEAR SHAPED / E27

PRODUCTION MATERIAL: **GLASS + ALUMINIUM BASE**  
 ΥΛΙΚΟ ΚΑΤΑΣΚΕΥΗΣ: **ΓΥΑΛΙ + ΒΑΣΗ ΑΛΟΥΜΙΝΙΟΥ**

Color  
Box  
PACKING



85-115V 50-60Hz 20000h LIFE TIME 0.00% Hg START TIME min: 0.3 sec -30°C ~ +45°C OPERATING TEMP.

NOT DIMMABLE A++ ENERGY CLASS 90% ENERGY SAVING 1 YEARS GUARANTEE

| BARCODE       | CODE      | BASE | TYPE        | WATT | KELVIN | LUMEN | Lm/W | mm  | PACKING | PRICE (€) |
|---------------|-----------|------|-------------|------|--------|-------|------|-----|---------|-----------|
| 5206139013927 | 147-86130 | E27  | Pear Shaped | 70W  | 4000K  | 6650  | 96   | 145 | 55 1/40 | 18.90     |
| 5206139013941 | 147-86131 | E27  | Pear Shaped | 100W | 4000K  | 9600  | 96   | 145 | 55 1/40 | 19.40     |
| 5206139013934 | 147-86132 | E27  | Pear Shaped | 150W | 4000K  | 14400 | 96   | 145 | 55 1/40 | 19.80     |

ΦΩΤΟΜΕΤΡΙΚΑ / PHOTOMETRY

ΦΑΣΜΑΤΙΚΗ ΚΑΤΑΝΟΜΗ  
SPECTRAL DISTRIBUTION

ΧΡΩΜΑΤΙΚΟ ΔΙΑΓΡΑΜΜΑ  
COLOR DIAGRAM

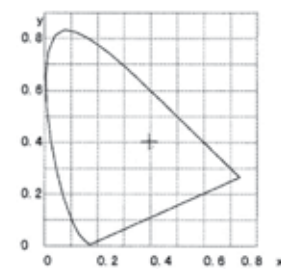
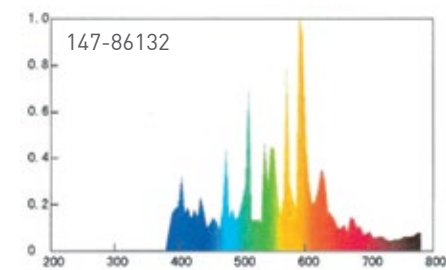
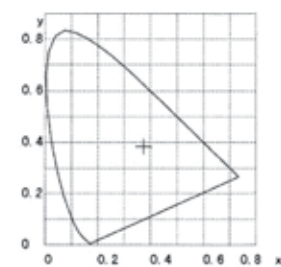
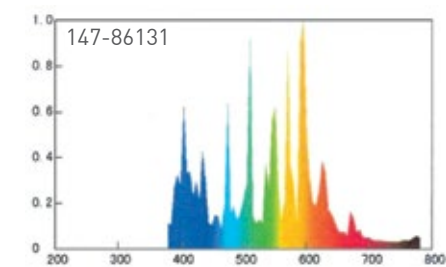
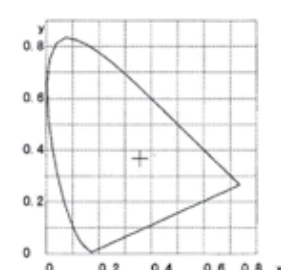
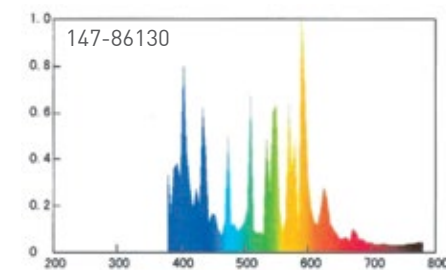

- METAL HALIDE COATED LAMP WITH IGNITOR
- ΛΑΜΠΗΤΗΡΑΣ ΜΕΤΑΛΛΟΥ ΜΕ ΕΚΚΙΝΗΤΗ
- PEAR SHAPED / E27 - E40

PRODUCTION MATERIAL: **GLASS + ALUMINIUM BASE**  
 ΥΛΙΚΟ ΚΑΤΑΣΚΕΥΗΣ: **ΓΥΑΛΙ + ΒΑΣΗ ΑΛΟΥΜΙΝΙΟΥ**

Color  
Box  
PACKING



220-240V 50-60Hz 20000h LIFE TIME 0.00% Hg START TIME min: 0.3 sec -30°C ~ +45°C OPERATING TEMP.

NOT DIMMABLE A++ ENERGY CLASS 90% ENERGY SAVING 1 YEARS GUARANTEE

| BARCODE       | CODE      | BASE | TYPE        | WATT | KELVIN | LUMEN | Lm/W | mm  | PACKING | PRICE (€) |
|---------------|-----------|------|-------------|------|--------|-------|------|-----|---------|-----------|
| 5207227004254 | 147-86141 | E27  | Pear Shaped | 125W | 4000K  | 12000 | 96   | 185 | 76 1/12 | 24.60     |
| 5207227004285 | 147-86142 | E40  | Pear Shaped | 250W | 4000K  | 25000 | 100  | 228 | 90 1/12 | 31.50     |

ΦΩΤΟΜΕΤΡΙΚΑ / PHOTOMETRY

ΦΑΣΜΑΤΙΚΗ ΚΑΤΑΝΟΜΗ  
SPECTRAL DISTRIBUTION

ΧΡΩΜΑΤΙΚΟ ΔΙΑΓΡΑΜΜΑ  
COLOR DIAGRAM

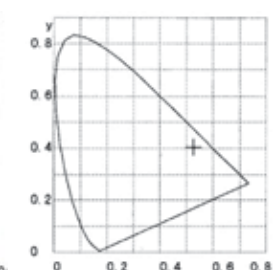
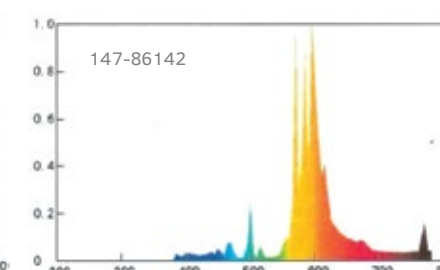
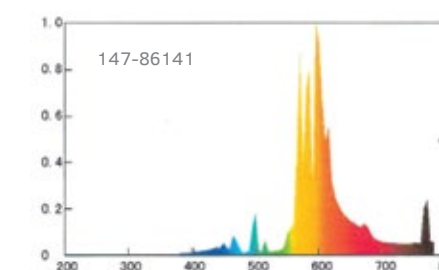



Type: BR38 / PAR38 / A60 / G45 / T28 / T25 / T23 / T22

INCANDESCENT Lamps

Discover our Collection ►

• INCANDESCENT BULBS • ΛΑΜΠΤΗΡΕΣ ΠΥΡΑΚΤΩΣΕΩΣ  
12V / 24V / 42V • A60 - E27



PRODUCTION MATERIAL: **GLASS + ALUMINIUM BASE**  
ΥΛΙΚΟ ΚΑΤΑΣΚΕΥΗΣ: **ΓΥΑΛΙ + ΒΑΣΗ ΑΛΟΥΜΙΝΙΟΥ**



| BARCODE       | CODE      | BASE | TYPE | VOLT | WATT | LUMEN | ↑ mm | ∅  | PACKING  | PRICE (€) |
|---------------|-----------|------|------|------|------|-------|------|----|----------|-----------|
| 5206139000804 | 147-88116 | E27  | A60  | 42V  | 40W  | 400   | 107  | 60 | 1/10/100 | 1.05      |
| 5206139000811 | 147-88117 | E27  | A60  | 42V  | 60W  | 660   | 107  | 60 | 1/10/100 | 1.05      |
| 5206139000828 | 147-88130 | E27  | A60  | 12V  | 40W  | 400   | 107  | 60 | 1/10/100 | 1.05      |
| 5206139000835 | 147-88131 | E27  | A60  | 12V  | 60W  | 660   | 107  | 60 | 1/10/100 | 1.05      |
| 5206139000842 | 147-88132 | E27  | A60  | 24V  | 40W  | 400   | 107  | 60 | 1/10/100 | 1.05      |
| 5206139000859 | 147-88133 | E27  | A60  | 24V  | 60W  | 660   | 107  | 60 | 1/10/100 | 1.05      |

• INFRARED BULBS • ΛΑΜΠΤΗΡΑΣ ΧΟΙΡΟΣΤΑΣΙΟΥ  
INCANDESCENT • ΠΥΡΑΚΤΩΣΕΩΣ  
BR38 / PAR38 - E27

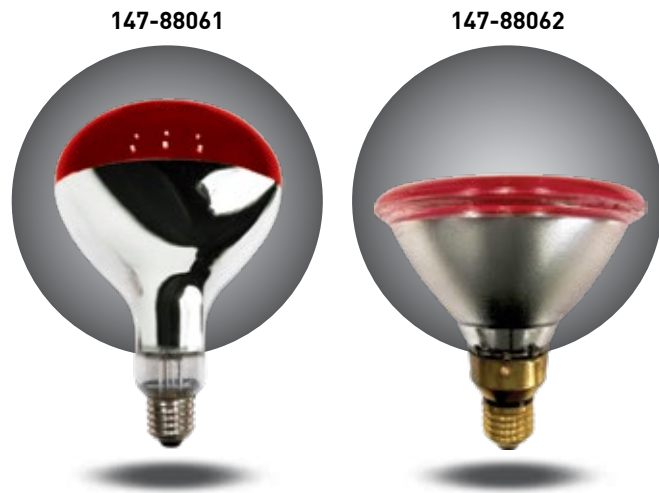

PRODUCTION MATERIAL: **RED GLASS COVER + ALUMINIUM BASE**  
ΥΛΙΚΟ ΚΑΤΑΣΚΕΥΗΣ: **ΚΟΚΚΙΝΟ ΓΥΑΛΙ + ΒΑΣΗ ΑΛΟΥΜΙΝΙΟΥ**



| BARCODE       | CODE      | BASE | TYPE  | WATT | LIGHT COLOR | ↑ mm | ∅   | PACKING | PRICE (€) |
|---------------|-----------|------|-------|------|-------------|------|-----|---------|-----------|
| 5206139001757 | 147-88061 | E27  | BR38  | 250W | RED         | 183  | 125 | 1/24    | 10.95     |
| 5206139005021 | 147-88062 | E27  | PAR38 | 175W | RED         | 139  | 120 | 1/12    | 9.30      |

• REFRIGERATOR LAMP • ΛΑΜΠΤΗΡΑΣ ΨΥΓΕΙΟΥ  
E14



PRODUCTION MATERIAL: **GLASS + ALUMINIUM BASE**  
ΥΛΙΚΟ ΚΑΤΑΣΚΕΥΗΣ: **ΓΥΑΛΙ + ΒΑΣΗ ΑΛΟΥΜΙΝΙΟΥ**

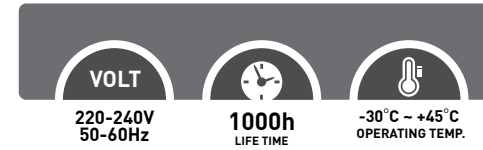

| Color Box PACKING | BARCODE       | CODE      | BASE | TYPE | WATT | LUMEN | ↑ mm | ∅  | PACKING  | PRICE (€) |
|-------------------|---------------|-----------|------|------|------|-------|------|----|----------|-----------|
|                   | 5206139000088 | 147-88094 | E14  | T22  | 15W  | 120   | 53   | 20 | 1/25/500 | 0.66      |

| 2 PCS Single Blister PACKING | BARCODE       | CODE      | BASE | TYPE | WATT | LUMEN | ↑ mm | ∅  | PACKING  | PRICE (€) |
|------------------------------|---------------|-----------|------|------|------|-------|------|----|----------|-----------|
|                              | 5206139000293 | 800-88094 | E14  | T22  | 15W  | 120   | 53   | 20 | 1/10/200 | 1.36      |

• OVEN LAMPS • ΛΑΜΠΤΗΡΕΣ ΦΟΥΡΝΟΥ  
E14



PRODUCTION MATERIAL: **GLASS + ALUMINIUM BASE**  
ΥΛΙΚΟ ΚΑΤΑΣΚΕΥΗΣ: **ΓΥΑΛΙ + ΒΑΣΗ ΑΛΟΥΜΙΝΙΟΥ**

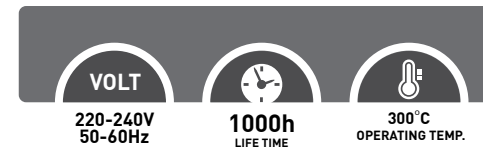

| Color Box PACKING | BARCODE       | CODE      | BASE | TYPE | WATT | LUMEN | ↑ mm | ∅  | PACKING  | PRICE (€) |
|-------------------|---------------|-----------|------|------|------|-------|------|----|----------|-----------|
|                   | 5206139000095 | 147-88095 | E14  | T22  | 15W  | 120   | 53   | 22 | 1/25/500 | 1.55      |

| 2 PCS Single Blister PACKING | BARCODE       | CODE      | BASE | TYPE | WATT | LUMEN | ↑ mm | ∅  | PACKING  | PRICE (€) |
|------------------------------|---------------|-----------|------|------|------|-------|------|----|----------|-----------|
|                              | 5206139000521 | 800-88095 | E14  | T22  | 15W  | 120   | 53   | 22 | 1/10/200 | 2.58      |

• OVEN MINI GLOBE LAMP  
• ΛΑΜΠΤΗΡΑΣ ΦΟΥΡΝΟΥ ΣΦΑΙΡΙΚΟΣ  
E14



PRODUCTION MATERIAL: **GLASS + ALUMINIUM BASE**  
ΥΛΙΚΟ ΚΑΤΑΣΚΕΥΗΣ: **ΓΥΑΛΙ + ΒΑΣΗ ΑΛΟΥΜΙΝΙΟΥ**

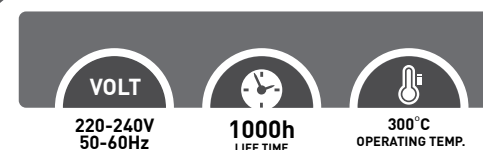

| Color Box PACKING | BARCODE       | CODE      | BASE | TYPE | WATT | LUMEN | ↑ mm | ∅  | PACKING | PRICE (€) |
|-------------------|---------------|-----------|------|------|------|-------|------|----|---------|-----------|
|                   | 5206139040176 | 147-88096 | E14  | G45  | 40W  | 200   | 80   | 45 | 1/10/10 | 1.85      |

• TUBE LAMPS • ΛΑΜΠΤΗΡΕΣ ΣΩΛΗΝΩΤΟΙ  
E14



PRODUCTION MATERIAL: **GLASS + ALUMINIUM BASE**  
ΥΛΙΚΟ ΚΑΤΑΣΚΕΥΗΣ: **ΓΥΑΛΙ + ΒΑΣΗ ΑΛΟΥΜΙΝΙΟΥ**



Color Box PACKING



| BARCODE       | CODE      | BASE | TYPE | WATT | LUMEN | ↑ mm | ∅  | PACKING  | PRICE (€) |
|---------------|-----------|------|------|------|-------|------|----|----------|-----------|
| 5206139000842 | 147-88097 | E14  | T28  | 25W  | 200   | 96   | 28 | 1/25/500 | 1.25      |
| 5206139000477 | 147-88098 | E14  | T28  | 40W  | 400   | 96   | 28 | 1/25/500 | 1.25      |

• NIGHT LAMP CLEAR • ΛΑΜΠΤΗΡΑΣ ΝΥΚΤΟΣ ΔΙΑΦΑΝΟΣ  
E12



PRODUCTION MATERIAL: **GLASS + ALUMINIUM BASE**  
ΥΛΙΚΟ ΚΑΤΑΣΚΕΥΗΣ: **ΓΥΑΛΙ + ΒΑΣΗ ΑΛΟΥΜΙΝΙΟΥ**



Color Box PACKING



| BARCODE       | CODE      | BASE | TYPE | WATT | LUMEN | ↑ mm | ∅  | PACKING  | PRICE (€) |
|---------------|-----------|------|------|------|-------|------|----|----------|-----------|
| 5206139000071 | 147-88092 | E12  | T23  | 7W   | 56    | 54   | 23 | 1/25/500 | 0.55      |

• NIGHT BULBS • ΛΑΜΠΤΗΡΕΣ ΝΥΚΤΟΣ  
E14



PRODUCTION MATERIAL: **GLASS + ALUMINIUM BASE**  
ΥΛΙΚΟ ΚΑΤΑΣΚΕΥΗΣ: **ΓΥΑΛΙ + ΒΑΣΗ ΑΛΟΥΜΙΝΙΟΥ**

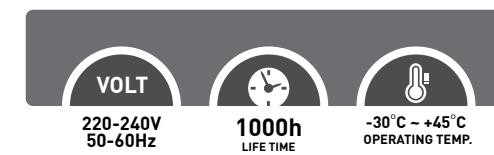

Color Box PACKING



| BARCODE       | CODE      | BASE | TYPE | WATT | LUMEN | COVER | ↑ mm | ∅  | PACKING  | PRICE (€) |
|---------------|-----------|------|------|------|-------|-------|------|----|----------|-----------|
| 5206139000590 | 147-88180 | E14  | T23  | 5W   | 25    | CLEAR | 53   | 20 | 1/25/500 | 0.55      |
| 5206139000712 | 147-88181 | E14  | T23  | 5W   | 25    | FROST | 53   | 20 | 1/25/500 | 0.55      |
| 5206139000064 | 147-88182 | E14  | T23  | 5W   | ---   |       | 53   | 20 | 1/25/500 | 0.55      |
| 5206139000736 | 147-88183 | E14  | T23  | 5W   | ---   |       | 53   | 20 | 1/25/500 | 0.55      |
| 5206139000743 | 147-88184 | E14  | T23  | 5W   | ---   |       | 53   | 20 | 1/25/500 | 0.55      |
| 5206139000750 | 147-88185 | E14  | T23  | 5W   | ---   |       | 53   | 20 | 1/25/500 | 0.55      |

3 PCS Single Blister PACKING



| BARCODE       | CODE      | BASE | TYPE | WATT | LUMEN | COVER | ↑ mm | ∅  | PACKING  | PRICE (€) |
|---------------|-----------|------|------|------|-------|-------|------|----|----------|-----------|
| 5206139000538 | 800-88180 | E14  | T23  | 5W   | 25    | CLEAR | 53   | 20 | 1/10/200 | 1.54      |
| 5206139000545 | 800-88181 | E14  | T23  | 5W   | 25    | FROST | 53   | 20 | 1/10/200 | 1.54      |
| 5206139000552 | 800-88182 | E14  | T23  | 5W   | ---   |       | 53   | 20 | 1/10/200 | 1.54      |
| 5206139000569 | 800-88183 | E14  | T23  | 5W   | ---   |       | 53   | 20 | 1/10/200 | 1.54      |
| 5206139000576 | 800-88184 | E14  | T23  | 5W   | ---   |       | 53   | 20 | 1/10/200 | 1.54      |
| 5206139000583 | 800-88185 | E14  | T23  | 5W   | ---   |       | 53   | 20 | 1/10/200 | 1.54      |

• NIGHT BULBS • ΛΑΜΠΤΗΡΕΣ ΝΥΚΤΟΣ  
E27 - B22

PRODUCTION MATERIAL: **GLASS + ALUMINIUM BASE**  
ΥΛΙΚΟ ΚΑΤΑΣΚΕΥΗΣ: **ΓΥΑΛΙ + ΒΑΣΗ ΑΛΟΥΜΙΝΙΟΥ**



Color Box PACKING

| BARCODE       | CODE      | BASE | TYPE | WATT | LUMEN | COVER  | mm | mm | PACKING  | PRICE (€) |
|---------------|-----------|------|------|------|-------|--------|----|----|----------|-----------|
| 5206139000224 | 147-88170 | E27  | T30  | 5W   | 25    | CLEAR  | 60 | 30 | 1/25/500 | 0.65      |
| 5206139000231 | 147-88171 | E27  | T30  | 5W   | 25    | FROST  | 60 | 30 | 1/25/500 | 0.65      |
| 5206139000248 | 147-88172 | E27  | T30  | 5W   | ---   | Red    | 60 | 30 | 1/25/500 | 0.65      |
| 5206139000255 | 147-88173 | E27  | T30  | 5W   | ---   | Yellow | 60 | 30 | 1/25/500 | 0.65      |
| 5206139000262 | 147-88174 | E27  | T30  | 5W   | ---   | Green  | 60 | 30 | 1/25/500 | 0.65      |
| 5206139000279 | 147-88175 | E27  | T30  | 5W   | ---   | Blue   | 60 | 30 | 1/25/500 | 0.65      |

2 PCS Single Blister PACKING

| BARCODE       | CODE      | BASE | TYPE | WATT | LUMEN | COVER  | mm | mm | PACKING  | PRICE (€) |
|---------------|-----------|------|------|------|-------|--------|----|----|----------|-----------|
| 5206139000767 | 800-88170 | E27  | T30  | 5W   | 25    | CLEAR  | 60 | 30 | 1/10/200 | 1.22      |
| 5206139000774 | 800-88171 | E27  | T30  | 5W   | 25    | FROST  | 60 | 30 | 1/10/200 | 1.22      |
| 5206139000781 | 800-88172 | E27  | T30  | 5W   | ---   | Red    | 60 | 30 | 1/10/200 | 1.22      |
| 5206139000798 | 800-88173 | E27  | T30  | 5W   | ---   | Yellow | 60 | 30 | 1/10/200 | 1.22      |
| 5206139001764 | 800-88174 | E27  | T30  | 5W   | ---   | Green  | 60 | 30 | 1/10/200 | 1.22      |
| 5206139001771 | 800-88175 | E27  | T30  | 5W   | ---   | Blue   | 60 | 30 | 1/10/200 | 1.22      |



2 PCS Single Blister PACKING

| BARCODE       | CODE      | BASE | TYPE | WATT | LUMEN | COVER | mm | mm | PACKING  | PRICE (€) |
|---------------|-----------|------|------|------|-------|-------|----|----|----------|-----------|
| 5206139043429 | 800-88160 | B22  | T30  | 5W   | 25    | CLEAR | 60 | 30 | 1/10/200 | 1.48      |





**EUROLAMP®**

 **Westinghouse**

Types: ALKALINE / LITHIUM / RECHARGEABLE

Batteries

Discover our Collection ►

**SUPER POWER ALKALINE**

- ALKALINE BATTERIES • ΑΛΚΑΛΙΚΕΣ ΜΠΑΤΑΡΙΕΣ
- AAA-LR03 / AA-LR6**



|               |           |                 |           |
|---------------|-----------|-----------------|-----------|
| VOLT          | TYPE      | MERCURY CADMIUM | A         |
| 1.5V          | AAA LR03  | 0.00%           | ALKALINE  |
| BARCODE       | CODE      | PACKING         | PRICE (€) |
| 5206139090003 | 147-24100 | 1/12/120        | 1.74      |



|               |           |                 |           |
|---------------|-----------|-----------------|-----------|
| VOLT          | TYPE      | MERCURY CADMIUM | A         |
| 1.5V          | AAA LR03  | 0.00%           | ALKALINE  |
| BARCODE       | CODE      | PACKING         | PRICE (€) |
| 5207227064470 | 147-24150 | 1/10/30         | 3.30      |



|               |           |                 |           |
|---------------|-----------|-----------------|-----------|
| VOLT          | TYPE      | MERCURY CADMIUM | A         |
| 1.5V          | AA LR6    | 0.00%           | ALKALINE  |
| BARCODE       | CODE      | PACKING         | PRICE (€) |
| 5206139090010 | 147-24101 | 1/12/120        | 1.76      |



|               |           |                 |           |
|---------------|-----------|-----------------|-----------|
| VOLT          | TYPE      | MERCURY CADMIUM | A         |
| 1.5V          | AA LR6    | 0.00%           | ALKALINE  |
| BARCODE       | CODE      | PACKING         | PRICE (€) |
| 5207227064500 | 147-24151 | 1/10/30         | 3.30      |



**SUPER POWER ALKALINE**

- ALKALINE BATTERIES • ΑΛΚΑΛΙΚΕΣ ΜΠΑΤΑΡΙΕΣ
- D-LR20 / C-LR14 / 6-LR61 / 23A**



|               |           |                 |           |
|---------------|-----------|-----------------|-----------|
| VOLT          | TYPE      | MERCURY CADMIUM | A         |
| 1.5V          | CLR14     | 0.00%           | ALKALINE  |
| BARCODE       | CODE      | PACKING         | PRICE (€) |
| 5206139090027 | 147-24102 | 1/12/72         | 3.26      |



|               |           |                 |           |
|---------------|-----------|-----------------|-----------|
| VOLT          | TYPE      | MERCURY CADMIUM | A         |
| 1.5V          | DLR20     | 0.00%           | ALKALINE  |
| BARCODE       | CODE      | PACKING         | PRICE (€) |
| 5206139090034 | 147-24103 | 1/12/72         | 4.72      |



|               |           |                 |           |
|---------------|-----------|-----------------|-----------|
| VOLT          | TYPE      | MERCURY CADMIUM | A         |
| 9V            | 6LR61     | 0.00%           | ALKALINE  |
| BARCODE       | CODE      | PACKING         | PRICE (€) |
| 5206139090041 | 147-24104 | 1/12/240        | 2.64      |



|               |           |                 |           |
|---------------|-----------|-----------------|-----------|
| VOLT          | TYPE      | MERCURY CADMIUM | A         |
| 12V           | 23A       | 0.00%           | ALKALINE  |
| BARCODE       | CODE      | PACKING         | PRICE (€) |
| 5206139090058 | 147-24105 | 1/20/200        | 6.67      |



**SUPER POWER ALKALINE**

• ALKALINE BATTERIES • ΑΛΚΑΛΙΚΕΣ ΜΠΑΤΑΡΙΕΣ

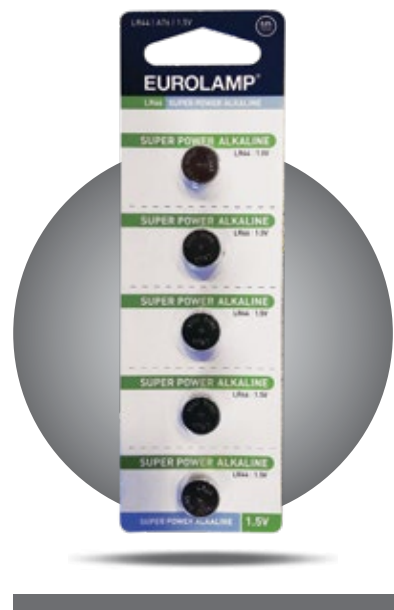

|               |             |                 |          |           |  |
|---------------|-------------|-----------------|----------|-----------|--|
| VOLT          | TYPE        | MERCURY CADMIUM | ALKALINE |           |  |
| 1.5V          | A76<br>LR44 | 0.00%           |          |           |  |
| BARCODE       | CODE        | mm              | PACKING  | PRICE (€) |  |
| 5206139096609 | 147-24112   | 11.6 5.4        | 1/12/120 | 1.52      |  |

• LITHIUM BATTERIES • ΜΠΑΤΑΡΙΕΣ ΛΙΘΙΟΥ



|               |           |                 |          |           |  |
|---------------|-----------|-----------------|----------|-----------|--|
| VOLT          | TYPE      | MERCURY CADMIUM | LITHIUM  |           |  |
| 3V            | CR2025    | 0.00%           |          |           |  |
| BARCODE       | CODE      | mm              | PACKING  | PRICE (€) |  |
| 5206139096593 | 147-24111 | 20 2.5          | 1/12/120 | 2.61      |  |



|               |           |                 |          |           |  |
|---------------|-----------|-----------------|----------|-----------|--|
| VOLT          | TYPE      | MERCURY CADMIUM | LITHIUM  |           |  |
| 3V            | CR2032    | 0.00%           |          |           |  |
| BARCODE       | CODE      | mm              | PACKING  | PRICE (€) |  |
| 5206139096586 | 147-24110 | 20 3.2          | 1/12/120 | 2.61      |  |

**SUPER POWER ALKALINE**

• ALKALINE BATTERIES • ΑΛΚΑΛΙΚΕΣ ΜΠΑΤΑΡΙΕΣ

AAA-LR03 / AA-LR6  
24PCS MULTIPACK



|               |             |                 |           |  |  |
|---------------|-------------|-----------------|-----------|--|--|
| VOLT          | TYPE        | MERCURY CADMIUM | ALKALINE  |  |  |
| 1.5V          | AAA<br>LR03 | 0.00%           |           |  |  |
| BARCODE       | CODE        | PACKING         | PRICE (€) |  |  |
| 5207227020124 | 147-24162   | 1/5/60          | 9.95      |  |  |



|               |           |                 |           |  |  |
|---------------|-----------|-----------------|-----------|--|--|
| VOLT          | TYPE      | MERCURY CADMIUM | ALKALINE  |  |  |
| 1.5V          | AA<br>LR6 | 0.00%           |           |  |  |
| BARCODE       | CODE      | PACKING         | PRICE (€) |  |  |
| 5207227020155 | 147-24163 | 1/5/30          | 10.54     |  |  |



• RECHARGEABLE BATTERIES • ΕΠΑΝΑΦΟΡΤΙΖΟΜΕΝΕΣ ΜΠΑΤΑΡΙΕΣ  
AAA-HR03 / AA-HR6



| VOLT            | TYPE      | CAPACITY | MERCURY CADMIUM | R            |
|-----------------|-----------|----------|-----------------|--------------|
| 1.2V            | AAA HR03  | 1000 mAh | 0.00%           | RECHARGEABLE |
| BARCODE         | CODE      | PACKING  | PRICE (€)       |              |
| 08895540-0111-0 | 920-24201 | 1/12/120 | 5.98            |              |



| VOLT            | TYPE      | CAPACITY | MERCURY CADMIUM | R            |
|-----------------|-----------|----------|-----------------|--------------|
| 1.2V            | AA HR6    | 2400 mAh | 0.00%           | RECHARGEABLE |
| BARCODE         | CODE      | PACKING  | PRICE (€)       |              |
| 08895540-0102-8 | 920-24210 | 1/12/120 | 9.20            |              |

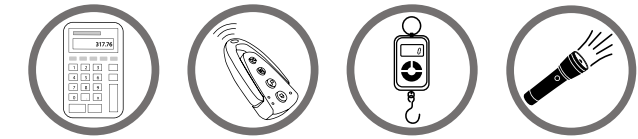

• ALKALINE BATTERIES • ΑΛΚΑΛΙΚΕΣ ΜΠΑΤΑΡΙΕΣ  
LR44



| VOLT            | TYPE      | MERCURY CADMIUM | A         |
|-----------------|-----------|-----------------|-----------|
| 1.5V            | LR44      | 0.00%           | ALKALINE  |
| BARCODE         | CODE      | PACKING         | PRICE (€) |
| 08895540-0194-3 | 920-24110 | 1/24/960        | 1.52      |

• LITHIUM BATTERIES • ΜΠΑΤΑΡΙΕΣ ΛΙΘΙΟΥ  
CR2016 / CR2025 / CR2032



| VOLT            | TYPE      | MERCURY CADMIUM | L         |
|-----------------|-----------|-----------------|-----------|
| 3V              | CR2016    | 0.00%           | LITHIUM   |
| BARCODE         | CODE      | PACKING         | PRICE (€) |
| 08895540-0154-7 | 920-24100 | 1/24/480        | 0.88      |



| VOLT            | TYPE      | MERCURY CADMIUM | L         |
|-----------------|-----------|-----------------|-----------|
| 3V              | CR2025    | 0.00%           | LITHIUM   |
| BARCODE         | CODE      | PACKING         | PRICE (€) |
| 08895540-0153-0 | 920-24101 | 1/24/480        | 0.88      |



| VOLT            | TYPE      | MERCURY CADMIUM | L         |
|-----------------|-----------|-----------------|-----------|
| 3V              | CR2032    | 0.00%           | LITHIUM   |
| BARCODE         | CODE      | PACKING         | PRICE (€) |
| 08895540-0152-3 | 920-24102 | 1/24/280        | 0.88      |



- LED BATTERY FLASH LIGHT
- LED ΦΑΚΟΣ ΜΠΑΤΑΡΙΑΣ

PRODUCTION MATERIAL: **TPR**  
ΥΛΙΚΟ ΚΑΤΑΣΚΕΥΗΣ: **TPR**



Εφεδρεία Μπαταρίας (Χρόνος Αποφόρτισης): **70** Ώρες  
Battery Discharge Time: **70** Hours

VOLT: 3V DC | BEAM ANGLE: 120° | LED: 3 LED WHITE | IP44 | TPR | BATTERY: 2\*AA | 100% → 0%: 70h | WEIGHT: 0.12 Kg | ON-OFF BUTTON

| BARCODE       | CODE      | COLOR | LED TYPE | LED CHIPS   | LUMEN | mm  | mm | PACKING | PRICE (€) |
|---------------|-----------|-------|----------|-------------|-------|-----|----|---------|-----------|
| 5206139072672 | 145-24500 | Blue  | CREE     | 3 WHITE LED | 30    | 160 | 43 | 1/6/24  | 6.85      |
| 5206139072726 | 145-24501 | Red   | CREE     | 3 WHITE LED | 30    | 160 | 43 | 1/6/24  | 6.85      |

- LED BATTERY FLASH LIGHT WITH ZOOM OPERATION
- LED ΦΑΚΟΣ ΜΠΑΤΑΡΙΑΣ ΑΛΟΥΜΙΝΙΟΥ ΜΕ ΛΕΙΤΟΥΡΓΙΑ ZOOM



PRODUCTION MATERIAL: **ALUMINIUM**  
ΥΛΙΚΟ ΚΑΤΑΣΚΕΥΗΣ: **ΑΛΟΥΜΙΝΙΟ**

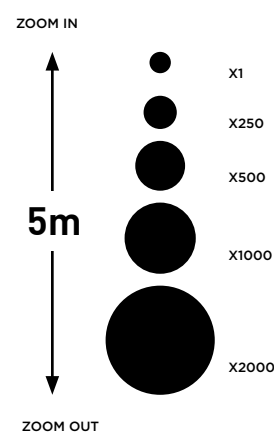

Εφεδρεία Μπαταρίας (Χρόνος Αποφόρτισης): **7** Ώρες  
Battery Discharge Time: **7** Hours

Εμβέλεια / Range: 100m  
Λειτουργία: Υψηλή-Χαμηλή-Διαδοχική-Zoom  
Function: High-Low-Flashing-Zoom

VOLT: 4.5V DC | BEAM ANGLE: 10° - 120° | LED: 1 COB LED | IP44 | ZOOM OPERATION | BATTERY: 3\*AAA | 100% → 0%: 7h | WEIGHT: 0.09 Kg | ON-OFF BUTTON

| BARCODE       | CODE      | LED TYPE | WATT   | LUMEN | mm  | mm   | PACKING | PRICE (€) |
|---------------|-----------|----------|--------|-------|-----|------|---------|-----------|
| 5206139080400 | 145-24507 | CREE     | 3W LED | 150   | 112 | 34.6 | 1/16/64 | 12.67     |



- LED BATTERY WORK LIGHT WITH MAGNET
- LED ΦΑΚΟΣ ΜΠΑΤΑΡΙΑΣ ΕΡΓΑΣΙΑΣ ΜΕ ΜΑΓΝΗΤΗ

PRODUCTION MATERIAL: **ABS**  
ΥΛΙΚΟ ΚΑΤΑΣΚΕΥΗΣ: **ABS**



Εφεδρεία Μπαταρίας (Χρόνος Αποφόρτισης): **18** Ώρες  
Battery Discharge Time: **18** Hours

Ενσωματωμένος Μαγνήτης & Γάντζος  
Embedded Magnet & Hook  
Λειτουργία: 3 Τρόποι Φωτισμού  
Function: 3 Ways of Lighting



VOLT: 3V DC | BEAM ANGLE: 120° | LED: 15+1 LED | IP44 | BATTERY: 2\*AA | 100% → 0%: 18h | WEIGHT: 0.106 Kg | ON-OFF BUTTON

| BARCODE       | CODE      | LED TYPE | LED CHIPS           | LUMEN    | DIMENSIONS (mm): | PACKING | PRICE (€) |
|---------------|-----------|----------|---------------------|----------|------------------|---------|-----------|
| 5206139080240 | 145-24504 | CREE XPE | 15 SMD & 1 CREE XPE | 120 & 80 | 151 x 36.5 x 46  | 1/6/24  | 18.44     |

- LED BATTERY HEAD LIGHT
- LED ΦΑΚΟΣ ΚΕΦΑΛΗΣ ΜΕ ΜΠΑΤΑΡΙΑ



PRODUCTION MATERIAL: **ABS**  
ΥΛΙΚΟ ΚΑΤΑΣΚΕΥΗΣ: **ABS**



Εφεδρεία Μπαταρίας (Χρόνος Αποφόρτισης): **7** Ώρες  
Battery Discharge Time: **7** Hours

Λειτουργία: Υψηλή-Χαμηλή-ΚΟΚΚΙΝΟ ΦΛΑΣ-OFF  
Function: High-Low-RED FLASHING-OFF

VOLT: 4.5V DC | BEAM ANGLE: 300° | LED: IP44 | BATTERY: 3\*AAA | 100% → 0%: 7h | WEIGHT: 0.065 Kg | ON-OFF BUTTON

| BARCODE       | CODE      | LED TYPE | LUMEN | DIMENSIONS (mm): | PACKING | PRICE (€) |
|---------------|-----------|----------|-------|------------------|---------|-----------|
| 5206139080219 | 145-24503 | CREE XPE | 150   | 60 x 48 x 30     | 1/6/24  | 15.63     |



- LED BATTERY CAMPING LANDERN
- LED ΦΑΝΑΡΙ ΜΠΑΤΑΡΙΑΣ ΓΙΑ CAMPING

PRODUCTION MATERIAL: **ABS**  
ΥΛΙΚΟ ΚΑΤΑΣΚΕΥΗΣ: **ABS**

Color  
Box  
PACKING



Εφεδρεία Μπαταρίας (Χρόνος Αποφόρτισης): **7** Ώρες  
Battery Discharge Time: **7** Hours

Λειτουργία: Υψηλή-Χαμηλή-OFF  
Function: High-Low-OFF



ΘΥΡΑ / CHARGER

|               |                    |                       |      |                    |    |             |                  |                          |                   |                      |                                  |              |           |          |                |                    |
|---------------|--------------------|-----------------------|------|--------------------|----|-------------|------------------|--------------------------|-------------------|----------------------|----------------------------------|--------------|-----------|----------|----------------|--------------------|
| VOLT<br>3V DC | BEAM ANGLE<br>300° | USB<br>ΘΥΡΑ / CHARGER | IP44 | 2*AA<br>or 1*18650 | 7h | 0.264<br>Kg | ON-OFF<br>BUTTON | BARCODE<br>5206139080172 | CODE<br>145-24502 | LED TYPE<br>CREE XPE | LED CHIPS<br>15 SMD & 1 CREE XPE | LUMEN<br>180 | mm<br>134 | mm<br>95 | PACKING<br>1/8 | PRICE (€)<br>18.22 |
|---------------|--------------------|-----------------------|------|--------------------|----|-------------|------------------|--------------------------|-------------------|----------------------|----------------------------------|--------------|-----------|----------|----------------|--------------------|



- LED BATTERY BULB • ΛΑΜΠΑ LED ΜΠΑΤΑΡΙΑΣ
- "PULL LIGHT"

PRODUCTION MATERIAL: **ABS & PVC**  
ΥΛΙΚΟ ΚΑΤΑΣΚΕΥΗΣ: **ABS & PVC**



Μήκος Κορδονιού: **109**cm  
Cord Length: **109**cm

Εφεδρεία Μπαταρίας (Χρόνος Αποφόρτισης): **24** Ώρες  
Battery Discharge Time: **24** Hours

|                          |                    |            |                    |            |             |                     |                                  |                          |                    |                   |                    |            |             |                |           |          |                    |                   |
|--------------------------|--------------------|------------|--------------------|------------|-------------|---------------------|----------------------------------|--------------------------|--------------------|-------------------|--------------------|------------|-------------|----------------|-----------|----------|--------------------|-------------------|
| VOLT<br>4.5V DC          | BEAM ANGLE<br>220° | IP44       | 3*AAA              | 24h        | 0.079<br>Kg | PULL DOWN<br>ON-OFF | -20°C ~ +50°C<br>OPERATING TEMP. | BARCODE<br>5207227055959 | CODE<br>145-24510  | COLOR<br>●        | CHIP BRAND<br>CREE | WATT<br>1W | LUMEN<br>50 | KELVIN<br>4000 | mm<br>160 | mm<br>55 | PACKING<br>1/12/48 | PRICE (€)<br>4.70 |
| BARCODE<br>5207227055966 | CODE<br>145-24511  | COLOR<br>● | CHIP BRAND<br>CREE | WATT<br>1W | LUMEN<br>50 | KELVIN<br>4000      | mm<br>160                        | mm<br>55                 | PACKING<br>1/12/48 | PRICE (€)<br>4.70 |                    |            |             |                |           |          |                    |                   |



- LED BATTERY BICYCLE FRONT LIGHT
- LED ΕΜΠΡΟΣΘΙΟΣ ΦΑΚΟΣ ΠΟΔΗΛΑΤΟΥ ΜΕ ΜΠΑΤΑΡΙΑ

PRODUCTION MATERIAL: **PLASTIC**  
ΥΛΙΚΟ ΚΑΤΑΣΚΕΥΗΣ: **ΠΛΑΣΤΙΚΟ**



Εφεδρεία Μπαταρίας (Χρόνος Αποφόρτισης): **22** Ώρες  
Battery Discharge Time: **22** Hours

\* Λειτουργία: 2 Επιλογές: Συνεχόμενο Φως / Φλας  
2 Mode Operation: Full Light / Flashing

\* Ρυθμιζόμενη Βάση  
Adjustable Bracket

|                 |                |      |       |     |             |                  |
|-----------------|----------------|------|-------|-----|-------------|------------------|
| VOLT<br>4.5V DC | 6 LED<br>WHITE | IP44 | 3*AAA | 22h | 0.087<br>Kg | ON-OFF<br>BUTTON |
|-----------------|----------------|------|-------|-----|-------------|------------------|



|                          |                   |             |                                  |                   |                   |
|--------------------------|-------------------|-------------|----------------------------------|-------------------|-------------------|
| BARCODE<br>5206139080363 | CODE<br>145-24506 | LUMEN<br>85 | DIMENSIONS (mm):<br>85 x 30 x 55 | PACKING<br>1/6/24 | PRICE (€)<br>6.67 |
|--------------------------|-------------------|-------------|----------------------------------|-------------------|-------------------|



- LED BATTERY BICYCLE BACK LIGHT
- LED ΟΠΙΣΘΙΟΣ ΦΑΚΟΣ ΠΟΔΗΛΑΤΟΥ ΜΕ ΜΠΑΤΑΡΙΑ

PRODUCTION MATERIAL: **PLASTIC**  
ΥΛΙΚΟ ΚΑΤΑΣΚΕΥΗΣ: **ΠΛΑΣΤΙΚΟ**



Εφεδρεία Μπαταρίας (Χρόνος Αποφόρτισης): **22** Ώρες  
Battery Discharge Time: **22** Hours

\* Λειτουργία: 4 Επιλογές Λειτουργίας: Συνεχής / Γρήγορη / Χαμηλή / Διαδοχική  
Function: 4 Mode Flashing: Full / Quick / Low / Sequence

\* Ρυθμιζόμενη Βάση  
Adjustable Bracket

|               |              |      |       |     |             |                  |
|---------------|--------------|------|-------|-----|-------------|------------------|
| VOLT<br>3V DC | 4 LED<br>RED | IP44 | 2*AAA | 22h | 0.059<br>Kg | ON-OFF<br>BUTTON |
|---------------|--------------|------|-------|-----|-------------|------------------|



|                          |                   |                                  |                   |                   |
|--------------------------|-------------------|----------------------------------|-------------------|-------------------|
| BARCODE<br>5206139080288 | CODE<br>145-24505 | DIMENSIONS (mm):<br>60 x 33 x 39 | PACKING<br>1/6/24 | PRICE (€)<br>5.77 |
|--------------------------|-------------------|----------------------------------|-------------------|-------------------|



- MEMORY BOARD WITH LED LIGHT
- LED ΦΩΤΙΖΟΜΕΝΟΣ ΠΙΝΑΚΑΣ ΣΗΜΕΙΩΣΕΩΝ

PRODUCTION MATERIAL: **PLASTIC**  
ΥΛΙΚΟ ΚΑΤΑΣΚΕΥΗΣ: **ΠΛΑΣΤΙΚΟ**

Color  
**Box**  
PACKING



Συμπεριλαμβάνονται 2 ειδικοί μαρκαδόροι  
Included 2 special markers



VOLT

9V DC

12 LED

WHITE

IP20

6\*AA

0.49

ON-OFF

BUTTON

BARCODE

CODE

COLOR

WATT

DIMENSIONS (mm):

PACKING

PRICE (€)

5207227055355

145-24509



max 0.72W

300 x 210 x 50

1/8

18.44



LIGHTING  
SECTION

ICONS EXPLANATION • ΕΠΕΞΗΓΗΣΗ ΕΙΚΟΝΙΔΙΩΝ

|                       |  |                                     |                       |  |                                |
|-----------------------|--|-------------------------------------|-----------------------|--|--------------------------------|
| Voltage               |  | Τάση                                | Flicker Free          |  | Flicker Free                   |
| Output Voltage        |  | Τάση Εξόδου                         | Lumens per Watt       |  | Lumens Ανά Βατ                 |
| Watt                  |  | Βατ                                 | Operating Temperature |  | Θερμοκρασία Λειτουργίας        |
| Amperage              |  | Ένταση Ρεύματος                     | Cutting Dimension     |  | Διάσταση Εγκοπής               |
| Energy Class          |  | Ενεργειακή Κλάση                    | Installation Height   |  | Ύψος Τοποθέτησης               |
| Appliance Class       |  | Τύπος Μόνωσης Καλωδίων              | On-Off Switches       |  | Ενεργοποίηση Απενεργοποίηση    |
| Grounding             |  | Γείωση                              | Life Time Hours       |  | Ώρες Ζωής                      |
| Ingress Protection    |  | Βαθμός Στεγανότητας                 | Start Time            |  | Χρόνος Έναυσης                 |
| Dimmable Device       |  | Δυνατότητα Ρύθμισης Φωτεινότητας    | Charging Time         |  | Χρόνος Φόρτισης                |
| Non-Dimmable Device   |  | Μη Δυνατότητα Ρύθμισης Φωτεινότητας | Discharge Time        |  | Χρόνος Αποφόρτισης             |
| Weight                |  | Βάρος                               | Battery Type          |  | Τύπος Μπαταρίας                |
| Beam Angle            |  | Γωνία Δέσμης Φωτός                  | Resist Impact Factor  |  | Δείκτης Ευθραυστότητας         |
| Power Factor          |  | Συντελεστής Ισχύος                  | Temperature in Kelvin |  | Θερμοκρασία Χρώματος σε Kelvin |
| Color Rendering Index |  | Δείκτης Χρωματικής Απόδοσης         | Sensor Type           |  | Τύπος Αισθητήρα                |

ICONS EXPLANATION • ΕΠΕΞΗΓΗΣΗ ΕΙΚΟΝΙΔΙΩΝ

|                              |  |                                |  |                            |
|------------------------------|--|--------------------------------|--|----------------------------|
| Maximum Watt in LED Lamp     |  | Μέγιστα Βατ σε Λάμπες LED      |  | Λευκό Κουτί με αυτοκόλλητο |
| Maximum Watt in Halogen Lamp |  | Μέγιστα Βατ σε Λάμπες Αλογόνου |  | Καφέ Κουτί με αυτοκόλλητο  |
| Lampholder                   |  | Ντουί Λαμπτήρα                 |  | Κουτί με δημιουργικό       |
| Lamp Type                    |  | Τύπος Λαμπτήρα                 |  | Καρτέλα με διπλό κάλυμμα   |
| LED Type                     |  | Τύπος LED                      |  | Ασημί Σακούλα              |
| Tape Length                  |  | Μήκος Ταινίας                  |  | Νάυλον Σακούλα             |
| Cutting Distance             |  | Απόσταση Κοπής                 |  | Πλαστική Σακούλα           |
| Expansion                    |  | Επιμήκυνση                     |  | Χαρτόνι στα πλαϊνά         |
| Channels                     |  | Δίοδοι                         |  | Κουτί PVC                  |
| Track Lines                  |  | Γραμμές Ράγας                  |  | Χύμα                       |

ΕΠΕΞΗΓΗΣΗ ΑΣΤΕΡΙΣΚΟΥ (\*) / ASTERISK EXPLANATION (\*):

• Οι κωδικοί που συνοδεύονται από αστερίσκο (\*), χαρακτηρίζονται από το αντίστοιχο Τεχνικό Χαρακτηριστικό, το οποίο φέρει και αυτό αστερίσκο (\*)

• The codes that are accompanied by an asterisk (\*), are characterized by the corresponding Technical Characteristic, which also has an asterisk (\*)

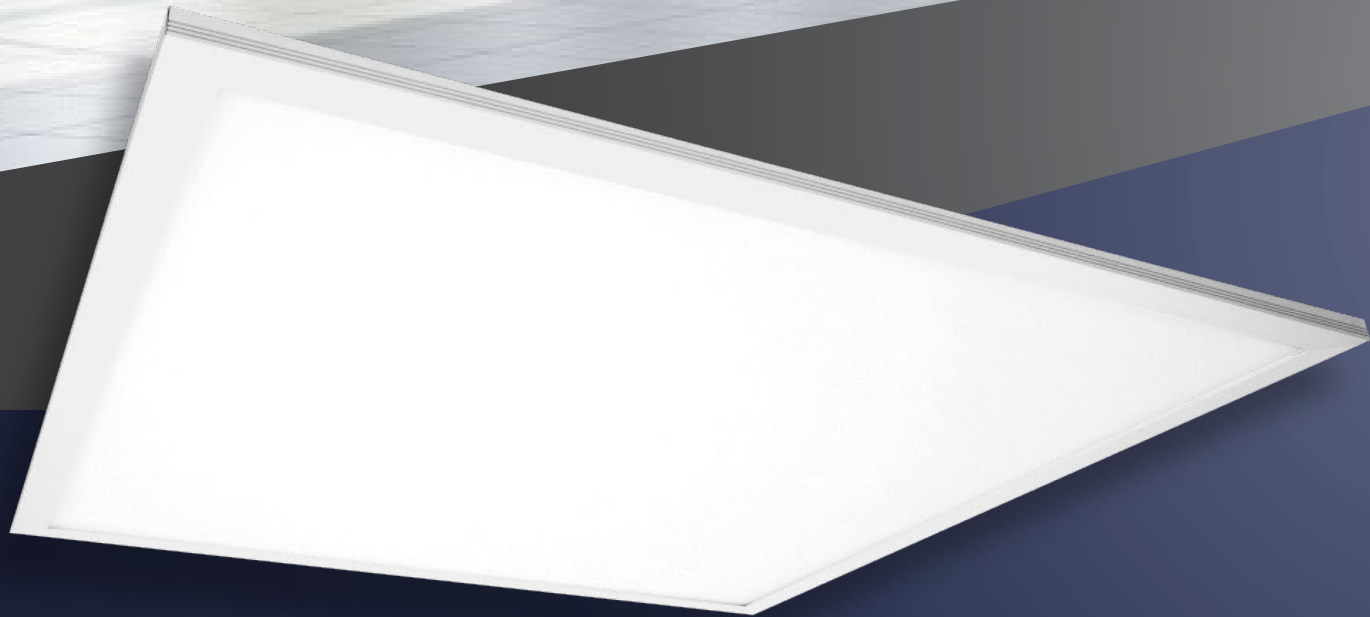

LED



### Φωτιστικά Πάνελ LED

για Οικιακή & Επαγγελματική Χρήση

Ιδανικοί για χρήση σε χώρους όπως:

- Κατοικίες
- Καταστήματα
- Εμπορικά Κέντρα
- Αποθήκες
- Βιοτεχνικούς Χώρους
- Βιομηχανικούς Χώρους
- Μοτέλ
- Ξενοδοχεία
- Αίθουσες Διδασκαλίας
- Εκθεσιακούς Χώρους
- Μουσεία
- Αρχιτεκτονικές Δομές
- Δημόσιες Εγκαταστάσεις

### LED Lighting Panels

for Domestic & Professional use

Ideal for use in places as:

- Residences
- Stores
- Shopping Malls
- Warehouses
- Business Areas
- Industrial Areas
- Motels
- Hotels
- Teaching Rooms
- Exhibitions
- Museums
- Architectural Structures
- Public Facilities

LED LIGHTING PANELS UGR • ΦΩΤΙΣΤΙΚΑ ΠΑΝΕΛ LED UGR

**NEW!**

PRODUCTION MATERIAL: ALUMINIUM & PLASTIC  
ΥΛΙΚΟ ΚΑΤΑΣΚΕΥΗΣ: ΑΛΟΥΜΙΝΙΟ & ΠΛΑΣΤΙΚΟ

595mm  
595mm  
8mm

BEAM ANGLE: 90°  
PF: >0.9  
Ra: >80  
WATT: 40W  
KELVIN: 6500K  
LUMEN / WATT: 105 lm/watt  
COLOR: WHITE  
PACKING: 1/5  
PRICE (€): 68.85

IP20, NOT DIMMABLE, A+ ENERGY CLASS, VOLT 220-240V 50-60Hz, INSTALLATION HEIGHT 2-3M, CLASS II, 2,300Kg, 2 YEARS GUARANTEE

BEAM ANGLE: 90°  
PF: >0.9  
Ra: >80  
WATT: 40W  
KELVIN: 6500K  
LUMEN / WATT: 105 lm/watt  
COLOR: WHITE  
PACKING: 1/5  
PRICE (€): 68.85

| BARCODE       | CODE      | WATT | KELVIN | LUMEN / WATT | COLOR | PACKING | PRICE (€) |
|---------------|-----------|------|--------|--------------|-------|---------|-----------|
| 5207227061691 | 145-56170 | 40W  | 6500K  | 105 lm/watt  | WHITE | 1/5     | 68.85     |
| 5207227061714 | 145-56171 | 40W  | 4000K  | 105 lm/watt  | WHITE | 1/5     | 68.85     |
| 5207227061738 | 145-56172 | 40W  | 3000K  | 95 lm/watt   | WHITE | 1/5     | 68.85     |

LED LIGHTING PANELS • ΦΩΤΙΣΤΙΚΑ ΠΑΝΕΛ LED

PRODUCTION MATERIAL: ALUMINIUM & PLASTIC  
ΥΛΙΚΟ ΚΑΤΑΣΚΕΥΗΣ: ΑΛΟΥΜΙΝΙΟ & ΠΛΑΣΤΙΚΟ

595mm  
595mm  
9mm

BEAM ANGLE: 110°  
PF: >0.9  
Ra: >80  
WATT: 40W  
KELVIN: 6500K  
LUMEN / WATT: 115 lm/watt  
COLOR: WHITE  
PACKING: 1/5  
PRICE (€): 48.90

IP20, NOT DIMMABLE, A+ ENERGY CLASS, VOLT 220-240V 50-60Hz, INSTALLATION HEIGHT 2-3M, CLASS II, 1.800Kg, 2 YEARS GUARANTEE

BEAM ANGLE: 110°  
PF: >0.9  
Ra: >80  
WATT: 40W  
KELVIN: 6500K  
LUMEN / WATT: 115 lm/watt  
COLOR: WHITE  
PACKING: 1/5  
PRICE (€): 48.90

| BARCODE       | CODE      | WATT | KELVIN | LUMEN / WATT | COLOR | PACKING | PRICE (€) |
|---------------|-----------|------|--------|--------------|-------|---------|-----------|
| 5207227033872 | 145-56160 | 40W  | 6500K  | 115 lm/watt  | WHITE | 1/5     | 48.90     |
| 5207227033889 | 145-56161 | 40W  | 4000K  | 113 lm/watt  | WHITE | 1/5     | 48.90     |
| 5207227033902 | 145-56162 | 40W  | 3000K  | 110 lm/watt  | WHITE | 1/5     | 48.90     |

**NEW!**

PRODUCTION MATERIAL: ALUMINIUM & PLASTIC  
ΥΛΙΚΟ ΚΑΤΑΣΚΕΥΗΣ: ΑΛΟΥΜΙΝΙΟ & ΠΛΑΣΤΙΚΟ

1195mm  
295mm  
8mm

BEAM ANGLE: 90°  
PF: >0.9  
Ra: >80  
WATT: 40W  
KELVIN: 6500K  
LUMEN / WATT: 105 lm/watt  
COLOR: WHITE  
PACKING: 1/5  
PRICE (€): 76.25

IP20, NOT DIMMABLE, A+ ENERGY CLASS, VOLT 220-240V 50-60Hz, INSTALLATION HEIGHT 2-3M, CLASS II, 2,500Kg, 2 YEARS GUARANTEE

BEAM ANGLE: 90°  
PF: >0.9  
Ra: >80  
WATT: 40W  
KELVIN: 6500K  
LUMEN / WATT: 105 lm/watt  
COLOR: WHITE  
PACKING: 1/5  
PRICE (€): 76.25

| BARCODE       | CODE      | WATT | KELVIN | LUMEN / WATT | COLOR | PACKING | PRICE (€) |
|---------------|-----------|------|--------|--------------|-------|---------|-----------|
| 5207227070082 | 145-56173 | 40W  | 6500K  | 105 lm/watt  | WHITE | 1/5     | 76.25     |
| 5207227070105 | 145-56174 | 40W  | 4000K  | 105 lm/watt  | WHITE | 1/5     | 76.25     |
| 5207227070129 | 145-56175 | 40W  | 3000K  | 95 lm/watt   | WHITE | 1/5     | 76.25     |

PRODUCTION MATERIAL: ALUMINIUM & PLASTIC  
ΥΛΙΚΟ ΚΑΤΑΣΚΕΥΗΣ: ΑΛΟΥΜΙΝΙΟ & ΠΛΑΣΤΙΚΟ

1195mm  
295mm  
9mm

BEAM ANGLE: 110°  
PF: >0.9  
Ra: >80  
WATT: 40W  
KELVIN: 6500K  
LUMEN / WATT: 115 lm/watt  
COLOR: WHITE  
PACKING: 1/5  
PRICE (€): 62.65

IP20, NOT DIMMABLE, A+ ENERGY CLASS, VOLT 220-240V 50-60Hz, INSTALLATION HEIGHT 2-3M, CLASS II, 2,300Kg, 2 YEARS GUARANTEE

BEAM ANGLE: 110°  
PF: >0.9  
Ra: >80  
WATT: 40W  
KELVIN: 6500K  
LUMEN / WATT: 115 lm/watt  
COLOR: WHITE  
PACKING: 1/5  
PRICE (€): 62.65

| BARCODE       | CODE      | WATT | KELVIN | LUMEN / WATT | COLOR | PACKING | PRICE (€) |
|---------------|-----------|------|--------|--------------|-------|---------|-----------|
| 5207227058561 | 145-56163 | 40W  | 6500K  | 115 lm/watt  | WHITE | 1/5     | 62.65     |
| 5207227058585 | 145-56164 | 40W  | 4000K  | 113 lm/watt  | WHITE | 1/5     | 62.65     |
| 5207227058608 | 145-56165 | 40W  | 3000K  | 110 lm/watt  | WHITE | 1/5     | 62.65     |

LED PANELS ACCESSORIES • ΑΞΕΣΟΥΑΡ ΦΩΤΙΣΤΙΚΩΝ ΠΑΝΕΛ LED

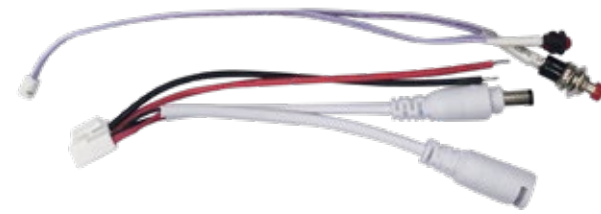

LED EMERGENCY KIT  
KIT ΑΣΦΑΛΕΙΑΣ ΕΦΕΔΡΙΚΟΥ ΦΩΤΙΣΜΟΥ  
BATTERY TYPE  
Lithium: 7,4V/2200mAh



| IP20          | VOLT<br>220-240V<br>50-60Hz | WATT<br>12-80W  | charging time<br>24h | discharge time<br>60-120 min | PF<br>>0.9 | LIFE TIME<br>15000h | kg<br>0.265Kg | OPERATING TEMP.<br>-25°C ~ +70°C | White Box with Sticker PACKING |
|---------------|-----------------------------|---|----------------------|------------------------------|------------|---------------------|---------------|----------------------------------|--------------------------------|
| BARCODE       | CODE                        | ΠΕΡΙΓΡΑΦΗ / DESCRIPTION   | PACKING              | PRICE (€)                    |            |                     |               |                                  |                                |
| 5207227058882 | 145-56180                   | ΤΡΟΦΟΔΟΤΙΚΟ ΜΠΑΤΑΡΙΑΣ UNIVERSAL<br>UNIVERSAL BATTERY EMERGENCY DRIVER | 1/50                 | 46.80                        |            |                     |               |                                  |                                |



| IP20          | VOLT<br>100-240V<br>50-60Hz | WATT<br>40W   | PF<br>>0.95 | LIFE TIME<br>25000h | kg<br>0.185Kg | OPERATING TEMP.<br>-20°C ~ +40°C | 2 YEARS WARRANTY |
|---------------|-----------------------------|---|-------------|---------------------|---------------|----------------------------------|------------------|
| BARCODE       | CODE                        | ΠΕΡΙΓΡΑΦΗ / DESCRIPTION   | PACKING     | PRICE (€)           |               |                                  |                  |
| 5206139044532 | 145-56195                   | ΤΡΟΦΟΔΟΤΙΚΟ DIMMABLE ΓΙΑ ΦΩΤΙΣΤΙΚΟ ΠΑΝΕΛ LED<br>DIMMABLE DRIVER FOR LED PANEL LIGHT | 1/50        | 39.50               |               |                                  |                  |



145-56196 5207227026188  
ΒΑΣΗ ΕΞΩΤΕΡΙΚΗ ΓΙΑ ΦΩΤΙΣΤΙΚΟ ΠΑΝΕΛ LED ΛΕΥΚΗ 60X60X4.3  
SURFACE BASE FOR LIGHT PANEL LED 60X60X4.3 WHITE  
1/25  
PRICE (€) 21.65



145-56197 5207227031298  
ΒΑΣΗ ΕΞΩΤΕΡΙΚΗ ΓΙΑ ΦΩΤΙΣΤΙΚΟ ΠΑΝΕΛ LED  
SURFACE BASE FOR LIGHT PANEL LED 120X30X4.3 WHITE  
1/25  
PRICE (€) 23.85



145-56190 5206139052278  
ΕΞΑΡΤΗΜΑ ΣΤΗΡΙΞΗΣ ΦΩΤΙΣΤΙΚΟΥ ΠΑΝΕΛ LED ΚΡΕΜΑΣΤΟ  
METAL SUSPENDING WIRE FOR LED PANEL  
1/100  
PRICE (€) 6.45



145-56191 5207227058615  
ΕΞΑΡΤΗΜΑ ΣΤΗΡΙΞΗΣ ΦΩΤΙΣΤΙΚΟΥ ΠΑΝΕΛ LED ΓΙΑ ΓΥΦΟΣΑΝΙΔΑ (CLIP)  
SPRING FASTENER (CLIP) FOR LED PANEL  
1/100  
PRICE (€) 4.65



145-68095 5207227060335  
ΣΤΕΦΑΝΙ ΥΠΟΣΤΗΡΙΞΗΣ ADAPTOR FRAME  
62,5x62,5CM  
1/1  
PRICE (€) 28.80



LED



Φωτιστικά Χωνευτά LED Slim

Recessed LED Slim Light Fixtures

για Οικιακή & Επαγγελματική Χρήση

for Domestic & Professional use

Ιδανικοί για χρήση σε χώρους όπως:

- Κατοικίες
- Καταστήματα
- Εμπορικά Κέντρα
- Αποθήκες
- Βιοτεχνικούς Χώρους
- Βιομηχανικούς Χώρους
- Μοτέλ
- Ξενοδοχεία
- Αίθουσες Διδασκαλίας
- Εκθεσιακούς Χώρους
- Μουσεία
- Αρχιτεκτονικές Δομές
- Δημόσιες Εγκαταστάσεις

Ideal for use in places as:

- Residences
- Stores
- Shopping Malls
- Warehouses
- Business Areas
- Industrial Areas
- Motels
- Hotels
- Teaching Rooms
- Exhibitions
- Museums
- Architectural Structures
- Public Facilities

RECESSED LED SLIM LIGHT FIXTURES SMD • ΦΩΤΙΣΤΙΚΑ ΧΩΝΕΥΤΑ LED SLIM SMD

PRODUCTION MATERIAL: ALUMINIUM & PLASTIC  
ΥΛΙΚΟ ΚΑΤΑΣΚΕΥΗΣ: ΑΛΟΥΜΙΝΙΟ & ΠΛΑΣΤΙΚΟ



85mm

10.5mm

PLUS

2 YEARS GUARANTEE

IP20 NOT DIMMABLE ENERGY CLASS A+ BEAM ANGLE 120° PF >0.5 Ra >80 15000 ON-OFF 30000h LIFE TIME START TIME min: 0.5 sec -10°C ~ +60°C OPERATING TEMP.

300mA 3M CLASS I SMD 2835 0.085Kg

VOLT 85-265V 50-60Hz

| BARCODE       | CODE      | WATT | KELVIN | LUMEN / WATT | COLOR | PACKING | PRICE (€) |
|---------------|-----------|------|--------|--------------|-------|---------|-----------|
| 5206139014931 | 145-68600 | 3W   | 6500K  | 90 lm/watt   | WHITE | 1/10/60 | 5.25      |
| 5206139037190 | 145-68601 | 3W   | 4000K  | 90 lm/watt   | WHITE | 1/10/60 | 5.25      |
| 5207227020544 | 145-68602 | 3W   | 3000K  | 90 lm/watt   | WHITE | 1/10/60 | 5.25      |
| 5206139037206 | 145-68604 | 3W   | 4000K  | 90 lm/watt   | SATIN | 1/10/60 | 5.75      |



120mm

10.5mm

PLUS

2 YEARS GUARANTEE

IP20 NOT DIMMABLE ENERGY CLASS A+ BEAM ANGLE 120° PF >0.5 Ra >80 15000 ON-OFF 30000h LIFE TIME START TIME min: 0.5 sec -10°C ~ +60°C OPERATING TEMP.

300mA 3M CLASS I SMD 2835 0.120Kg

VOLT 85-265V 50-60Hz

| BARCODE       | CODE      | WATT | KELVIN | LUMEN / WATT | COLOR | PACKING | PRICE (€) |
|---------------|-----------|------|--------|--------------|-------|---------|-----------|
| 5207227020568 | 145-68606 | 6W   | 6500K  | 90 lm/watt   | WHITE | 1/10/40 | 5.90      |
| 5207227020582 | 145-68608 | 6W   | 3000K  | 90 lm/watt   | WHITE | 1/10/40 | 5.90      |



145mm

10.5mm

PLUS

2 YEARS GUARANTEE

IP20 NOT DIMMABLE ENERGY CLASS A+ BEAM ANGLE 120° PF >0.5 Ra >80 15000 ON-OFF 30000h LIFE TIME START TIME min: 0.5 sec -10°C ~ +60°C OPERATING TEMP.

300mA 3M CLASS I SMD 2835 0.170Kg

VOLT 85-265V 50-60Hz

| BARCODE       | CODE      | WATT | KELVIN | LUMEN / WATT | COLOR | PACKING | PRICE (€) |
|---------------|-----------|------|--------|--------------|-------|---------|-----------|
| 5207227020605 | 145-68609 | 9W   | 6500K  | 90 lm/watt   | WHITE | 1/20    | 7.65      |
| 5207227020629 | 145-68611 | 9W   | 3000K  | 90 lm/watt   | WHITE | 1/20    | 7.65      |

RECESSED LED SLIM LIGHT FIXTURES SMD • ΦΩΤΙΣΤΙΚΑ ΧΩΝΕΥΤΑ LED SLIM SMD

PRODUCTION MATERIAL: ALUMINIUM & PLASTIC  
ΥΛΙΚΟ ΚΑΤΑΣΚΕΥΗΣ: ΑΛΟΥΜΙΝΙΟ & ΠΛΑΣΤΙΚΟ



170mm

10.5mm

PLUS

2 YEARS GUARANTEE

IP20 NOT DIMMABLE ENERGY CLASS A+ BEAM ANGLE 120° PF >0.5 Ra >80 15000 ON-OFF 30000h LIFE TIME START TIME min: 0.5 sec -10°C ~ +60°C OPERATING TEMP.

300mA 3M CLASS I SMD 2835 0.215Kg

VOLT 85-265V 50-60Hz

| BARCODE       | CODE      | WATT | KELVIN | LUMEN / WATT | COLOR | PACKING | PRICE (€) |
|---------------|-----------|------|--------|--------------|-------|---------|-----------|
| 5207227020643 | 145-68612 | 12W  | 6500K  | 90 lm/watt   | WHITE | 1/20    | 8.80      |
| 5207227020667 | 145-68614 | 12W  | 3000K  | 90 lm/watt   | WHITE | 1/20    | 8.80      |



225mm

10.5mm

VALUE

1 YEAR GUARANTEE

IP20 NOT DIMMABLE ENERGY CLASS A+ BEAM ANGLE 120° PF >0.5 Ra >80 15000 ON-OFF 30000h LIFE TIME START TIME min: 0.5 sec -10°C ~ +60°C OPERATING TEMP.

300mA 3M CLASS I SMD 2835 0.335Kg

VOLT 85-265V 50-60Hz

| BARCODE       | CODE      | WATT | KELVIN | LUMEN / WATT | COLOR | PACKING | PRICE (€) |
|---------------|-----------|------|--------|--------------|-------|---------|-----------|
| 5206139037824 | 145-68000 | 20W  | 6500K  | 90 lm/watt   | SATIN | 1/20    | 13.85     |
| 5206139037213 | 145-68001 | 20W  | 4000K  | 90 lm/watt   | SATIN | 1/20    | 13.85     |
| 5206139021427 | 145-68010 | 20W  | 6500K  | 90 lm/watt   | WHITE | 1/20    | 11.30     |
| 5206139021434 | 145-68011 | 20W  | 4000K  | 90 lm/watt   | WHITE | 1/20    | 11.30     |
| 5206139021441 | 145-68012 | 20W  | 3000K  | 90 lm/watt   | WHITE | 1/20    | 11.30     |

SPARE PARTS FOR LED SLIM PANELS • ΑΝΤΑΛΛΑΚΤΙΚΑ ΓΙΑ LED SLIM PANEL

| BARCODE       | CODE      | DESCRIPTION / ΠΕΡΙΓΡΑΦΗ  | COLOR  | PACKING | PRICE (€) |
|---------------|-----------|--|--------|---------|-----------|
| 5207227072178 | 145-68099 | ADAPTOR FRAME FROM Ø240 TO Ø225 ALUMINIUM ΣΤΕΦΑΝΙ ΥΠΟΣΤΗΡΙΞΗΣ Ø240 ΓΙΑ Φ225 ΑΛΟΥΜΙΝΙΟΥ | SILVER | 1/1     | 5.55      |

| BARCODE       | CODE      | DESCRIPTION / ΠΕΡΙΓΡΑΦΗ   | WATT | COLOR | PACKING | PRICE (€) |
|---------------|-----------|---|------|-------|---------|-----------|
| 5207227035494 | 145-68096 | ΤΡΟΦΟΔΟΤΙΚΟ ΓΙΑ LED SLIM PANEL 3 ΧΡΟΝΙΑ ΕΓΓΥΗΣΗ POWER SUPPLY (DRIVER) FOR LED PANEL 3 YRS GUARANTEE | 20W  | WHITE | 1/200   | 5.60      |
| 5207227039409 | 145-68097 | ΤΡΟΦΟΔΟΤΙΚΟ ΓΙΑ LED SLIM PANEL 1 ΧΡΟΝΟΣ ΕΓΓΥΗΣΗ POWER SUPPLY (DRIVER) FOR LED PANEL 1YR GUARANTEE   | 20W  | WHITE | 1/200   | 2.85      |

RECESSED LED SLIM LIGHT FIXTURES SMD • ΦΩΤΙΣΤΙΚΑ ΧΩΝΕΥΤΑ LED SLIM SMD

PRODUCTION MATERIAL: ALUMINIUM & PLASTIC  
ΥΛΙΚΟ ΚΑΤΑΣΚΕΥΗΣ: ΑΛΟΥΜΙΝΙΟ & ΠΛΑΣΤΙΚΟ

**NEW!** **HIGH Quality**

10.5mm  
225mm

IP20 NOT DIMMABLE A+ ENERGY CLASS Cutting hole ø210mm 300mA INSTALLATION HEIGHT 3M CLASS I SMD 2835 0.360Kg 3 YEARS WARRANTY

VOLT 85-265V 50-60Hz BEAM ANGLE 120° PF >0.5 Ra >80 15000 ON-OFF 30000h LIFE TIME START TIME min: 0.5 sec -10°C ~ +60°C OPERATING TEMP. Color Box PACKING

| BARCODE       | CODE      | WATT | KELVIN | LUMEN / WATT | COLOR | PACKING | PRICE (€) |
|---------------|-----------|------|--------|--------------|-------|---------|-----------|
| 5207227033551 | 145-68400 | 18W  | 6500K  | 105 lm/watt  | WHITE | 1/20    | 16.55     |
| 5207227033568 | 145-68401 | 18W  | 4000K  | 103 lm/watt  | WHITE | 1/20    | 16.55     |
| 5207227033575 | 145-68402 | 18W  | 3000K  | 95 lm/watt   | WHITE | 1/20    | 16.55     |
| 5207227033599 | 145-68410 | 18W  | 6500K  | 105 lm/watt  | SATIN | 1/20    | 18.65     |
| 5207227033612 | 145-68411 | 18W  | 4000K  | 103 lm/watt  | SATIN | 1/20    | 18.65     |
| 5207227033636 | 145-68412 | 18W  | 3000K  | 95 lm/watt   | SATIN | 1/20    | 18.65     |

**PLUS** **2 YEARS WARRANTY**

9mm  
220mm

IP20 NOT DIMMABLE A+ ENERGY CLASS Cutting hole ø205mm 300mA INSTALLATION HEIGHT 3.5M CLASS I SMD 2835 0.604Kg 2 YEARS WARRANTY

VOLT 85-265V 50-60Hz BEAM ANGLE 120° PF >0.5 Ra >80 15000 ON-OFF 30000h LIFE TIME START TIME min: 0.5 sec -10°C ~ +60°C OPERATING TEMP. Color Box PACKING

| BARCODE       | CODE      | WATT | KELVIN | LUMEN / WATT | COLOR | PACKING | PRICE (€) |
|---------------|-----------|------|--------|--------------|-------|---------|-----------|
| 5206139073440 | 145-68053 | 30W  | 6500K  | 90 lm/watt   | WHITE | 1/20    | 29.85     |
| 5206139073471 | 145-68054 | 30W  | 4000K  | 90 lm/watt   | WHITE | 1/20    | 29.85     |

**PLUS** **2 YEARS WARRANTY**

225mm 10.5mm 225mm

IP20 NOT DIMMABLE A+ ENERGY CLASS Cutting dimension 210x210mm 300mA INSTALLATION HEIGHT 3M CLASS I SMD 2835 0.360Kg 2 YEARS WARRANTY

VOLT 85-265V 50-60Hz BEAM ANGLE 120° PF >0.5 Ra >80 15000 ON-OFF 30000h LIFE TIME START TIME min: 0.5 sec -10°C ~ +60°C OPERATING TEMP. Color Box PACKING

| BARCODE       | CODE      | WATT | KELVIN | LUMEN / WATT | COLOR | PACKING | PRICE (€) |
|---------------|-----------|------|--------|--------------|-------|---------|-----------|
| 5206139026224 | 145-68020 | 20W  | 6500K  | 90 lm/watt   | WHITE | 1/20    | 11.30     |
| 5206139098900 | 145-68021 | 20W  | 4000K  | 90 lm/watt   | WHITE | 1/20    | 11.30     |

RECESSED LED SLIM LIGHT FIXTURES SMD WITH ADJUSTABLE CUT • ΦΩΤΙΣΤΙΚΑ ΧΩΝΕΥΤΑ LED SLIM SMD ΜΕ ΡΥΘΜΙΖΟΜΕΝΗ ΕΓΚΟΠΗ

PRODUCTION MATERIAL: ALUMINIUM & PLASTIC  
ΥΛΙΚΟ ΚΑΤΑΣΚΕΥΗΣ: ΑΛΟΥΜΙΝΙΟ & ΠΛΑΣΤΙΚΟ

**NEW!** **PLUS** **2 YEARS WARRANTY**

10.5mm  
115mm

IP20 NOT DIMMABLE A+ ENERGY CLASS Cutting hole ø50-110mm 300mA INSTALLATION HEIGHT 2M CLASS I SMD 2835 0.240Kg 2 YEARS WARRANTY

VOLT 85-265V 50-60Hz BEAM ANGLE 120° PF >0.5 Ra >80 30000 ON-OFF 30000h LIFE TIME START TIME min: 0.5 sec -10°C ~ +60°C OPERATING TEMP. Color Box PACKING

| BARCODE       | CODE      | WATT | KELVIN | LUMEN / WATT | COLOR | PACKING | PRICE (€) |
|---------------|-----------|------|--------|--------------|-------|---------|-----------|
| 5207227071911 | 145-68423 | 8W   | 6500K  | 105 lm/watt  | WHITE | 1/40    | 11.25     |
| 5207227071928 | 145-68424 | 8W   | 4000K  | 103 lm/watt  | WHITE | 1/40    | 11.25     |
| 5207227071935 | 145-68425 | 8W   | 3000K  | 95 lm/watt   | WHITE | 1/40    | 11.25     |

**NEW!** **PLUS** **2 YEARS WARRANTY**

12mm  
225mm

IP20 NOT DIMMABLE A+ ENERGY CLASS Cutting hole ø50-205mm 300mA INSTALLATION HEIGHT 3M CLASS I SMD 2835 0.340Kg 2 YEARS WARRANTY

VOLT 85-265V 50-60Hz BEAM ANGLE 120° PF >0.5 Ra >80 30000 ON-OFF 30000h LIFE TIME START TIME min: 0.5 sec -10°C ~ +60°C OPERATING TEMP. Color Box PACKING

| BARCODE       | CODE      | WATT | KELVIN | LUMEN / WATT | COLOR | PACKING | PRICE (€) |
|---------------|-----------|------|--------|--------------|-------|---------|-----------|
| 5207227033650 | 145-68420 | 20W  | 6500K  | 105 lm/watt  | WHITE | 1/20    | 19.85     |
| 5207227033674 | 145-68421 | 20W  | 4000K  | 103 lm/watt  | WHITE | 1/20    | 19.85     |
| 5207227033698 | 145-68422 | 20W  | 3000K  | 95 lm/watt   | WHITE | 1/20    | 19.85     |

RECESSED LED LIGHT FIXTURES COB • ΦΩΤΙΣΤΙΚΑ ΧΩΝΕΥΤΑ LED COB

PRODUCTION MATERIAL: ALUMINIUM & PLASTIC  
ΥΛΙΚΟ ΚΑΤΑΣΚΕΥΗΣ: ΑΛΟΥΜΙΝΙΟ & ΠΛΑΣΤΙΚΟ

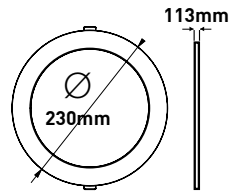

PLUS  
2 YEARS WARRANTY  
White Box with Sticker PACKING

| BARCODE       | CODE      | WATT | KELVIN | LUMEN / WATT | COLOR | PACKING | PRICE (€) |
|---------------|-----------|------|--------|--------------|-------|---------|-----------|
| 5207227008375 | 145-68205 | 55W  | 6500K  | 90 lm/watt   | WHITE | 1/10    | 78.60     |
| 5207227002502 | 145-68206 | 55W  | 4000K  | 90 lm/watt   | WHITE | 1/10    | 78.60     |

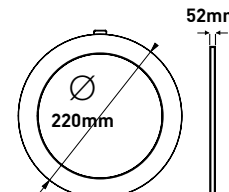

PLUS  
2 YEARS WARRANTY  
White Box with Sticker PACKING

| BARCODE       | CODE      | WATT | KELVIN | LUMEN / WATT | COLOR | PACKING | PRICE (€) |
|---------------|-----------|------|--------|--------------|-------|---------|-----------|
| 5206139025081 | 145-68201 | 30W  | 6500K  | 90 lm/watt   | WHITE | 1/20    | 19.45     |
| 5206139098665 | 145-68202 | 30W  | 4000K  | 90 lm/watt   | WHITE | 1/20    | 19.45     |

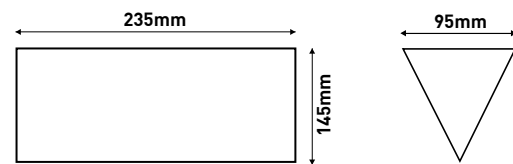

PRO  
2 YEARS WARRANTY  
White Box with Sticker PACKING

| BARCODE       | CODE      | WATT | KELVIN | LUMEN / WATT | COLOR | PACKING | PRICE (€) |
|---------------|-----------|------|--------|--------------|-------|---------|-----------|
| 5207227019098 | 145-68251 | 45W  | 4200K  | 58 lm/watt   | WHITE | 1/8     | 106.00    |



LED



Φωτιστικά Εξωτερικά LED Slim

για Οικιακή & Επαγγελματική Χρήση

Ιδανικοί για χρήση σε χώρους όπως:

- Κατοικίες
- Καταστήματα
- Εμπορικά Κέντρα
- Αποθήκες
- Βιοτεχνικούς Χώρους
- Βιομηχανικούς Χώρους
- Μοτέλ
- Ξενοδοχεία
- Αίθουσες Διδασκαλίας
- Εκθεσιακούς Χώρους
- Μουσεία
- Αρχιτεκτονικές Δομές
- Δημόσιες Εγκαταστάσεις

Surface LED Slim Light Fixtures

for Domestic & Professional use

Ideal for use in places as:

- Residences
- Stores
- Shopping Malls
- Warehouses
- Business Areas
- Industrial Areas
- Motels
- Hotels
- Teaching Rooms
- Exhibitions
- Museums
- Architectural Structures
- Public Facilities

SURFACE LED SLIM LIGHT FIXTURES • ΦΩΤΙΣΤΙΚΑ ΕΙΩΤΕΡΙΚΑ LED SLIM

**NEW!**

PRODUCTION MATERIAL: **ALUMINIUM & PLASTIC**  
ΥΛΙΚΟ ΚΑΤΑΣΚΕΥΗΣ: **ΑΛΟΥΜΙΝΙΟ & ΠΛΑΣΤΙΚΟ**

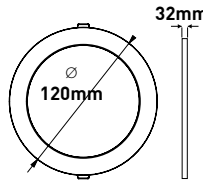
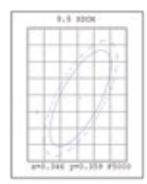
32mm

Ø 120mm

PLUS



IP20 NOT DIMMABLE ENERGY CLASS A+ 300mA INSTALLATION HEIGHT 2-3M CLASS II SMD 2835 0.215Kg 2 YEARS GUARANTEE

VOLT 85-265V 50-60Hz flicker free BEAM ANGLE 120° PF >0.5 Ra >80 15000 ON-OFF 30000h LIFE TIME START TIME min: 0.5 sec -10°C ~ +60°C OPERATING TEMP. Color Box PACKING

| BARCODE       | CODE      | WATT | KELVIN | LUMEN / WATT | COLOR | PACKING | PRICE (€) |
|---------------|-----------|------|--------|--------------|-------|---------|-----------|
| 5207227069468 | 145-68500 | 6W   | 6500K  | 90 lm/watt   | WHITE | 1/20    | 7.65      |
| 5207227069482 | 145-68501 | 6W   | 4000K  | 90 lm/watt   | WHITE | 1/20    | 7.65      |
| 5207227069505 | 145-68502 | 6W   | 3000K  | 90 lm/watt   | WHITE | 1/20    | 7.65      |

SURFACE LED SLIM LIGHT FIXTURES • ΦΩΤΙΣΤΙΚΑ ΕΙΩΤΕΡΙΚΑ LED SLIM

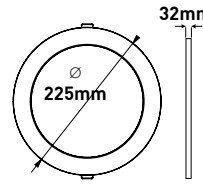
PRODUCTION MATERIAL: **ALUMINIUM & PLASTIC**  
ΥΛΙΚΟ ΚΑΤΑΣΚΕΥΗΣ: **ΑΛΟΥΜΙΝΙΟ & ΠΛΑΣΤΙΚΟ**

32mm

Ø 225mm

PLUS

IP20 NOT DIMMABLE ENERGY CLASS A+ 300mA INSTALLATION HEIGHT 2-3M CLASS I SMD 2835 0.450Kg 2 YEARS GUARANTEE

VOLT 85-265V 50-60Hz flicker free BEAM ANGLE 120° PF >0.5 Ra >80 15000 ON-OFF 30000h LIFE TIME START TIME min: 0.5 sec -10°C ~ +60°C OPERATING TEMP. Color Box PACKING

| BARCODE       | CODE      | WATT | KELVIN | LUMEN / WATT | COLOR | PACKING | PRICE (€) |
|---------------|-----------|------|--------|--------------|-------|---------|-----------|
| 5206139026583 | 145-68013 | 20W  | 6500K  | 90 lm/watt   | WHITE | 1/20    | 14.95     |
| 5206139020994 | 145-68014 | 20W  | 4000K  | 90 lm/watt   | WHITE | 1/20    | 14.95     |
| 5207227060274 | 145-68015 | 20W  | 3000K  | 90 lm/watt   | WHITE | 1/20    | 14.95     |

**NEW!**

PRODUCTION MATERIAL: **ALUMINIUM & PLASTIC**  
ΥΛΙΚΟ ΚΑΤΑΣΚΕΥΗΣ: **ΑΛΟΥΜΙΝΙΟ & ΠΛΑΣΤΙΚΟ**

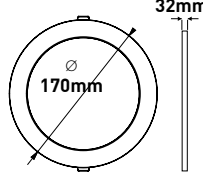
32mm

Ø 170mm



PLUS

IP20 NOT DIMMABLE ENERGY CLASS A+ 600mA INSTALLATION HEIGHT 2-3M CLASS II SMD 2835 0.320Kg 2 YEARS GUARANTEE

VOLT 85-265V 50-60Hz flicker free BEAM ANGLE 120° PF >0.5 Ra >80 15000 ON-OFF 30000h LIFE TIME START TIME min: 0.5 sec -10°C ~ +60°C OPERATING TEMP. Color Box PACKING

| BARCODE       | CODE      | WATT | KELVIN | LUMEN / WATT | COLOR | PACKING | PRICE (€) |
|---------------|-----------|------|--------|--------------|-------|---------|-----------|
| 5207227069529 | 145-68506 | 12W  | 6500K  | 90 lm/watt   | WHITE | 1/20    | 10.95     |
| 5207227069543 | 145-68507 | 12W  | 4000K  | 90 lm/watt   | WHITE | 1/20    | 10.95     |
| 5207227069567 | 145-68508 | 12W  | 3000K  | 90 lm/watt   | WHITE | 1/20    | 10.95     |

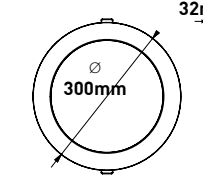
PRODUCTION MATERIAL: **ALUMINIUM & PLASTIC**  
ΥΛΙΚΟ ΚΑΤΑΣΚΕΥΗΣ: **ΑΛΟΥΜΙΝΙΟ & ΠΛΑΣΤΙΚΟ**

32mm

Ø 300mm

PLUS

IP20 NOT DIMMABLE ENERGY CLASS A+ 300mA INSTALLATION HEIGHT 2-3M CLASS I SMD 2835 0.700Kg 2 YEARS GUARANTEE

VOLT 85-265V 50-60Hz flicker free BEAM ANGLE 120° PF >0.5 Ra >80 15000 ON-OFF 30000h LIFE TIME START TIME min: 0.5 sec -10°C ~ +60°C OPERATING TEMP. Color Box PACKING

| BARCODE       | CODE      | WATT | KELVIN | LUMEN / WATT | COLOR | PACKING | PRICE (€) |
|---------------|-----------|------|--------|--------------|-------|---------|-----------|
| 5206139044556 | 145-68018 | 24W  | 6500K  | 90 lm/watt   | WHITE | 1/20    | 22.65     |
| 5206139010377 | 145-68019 | 24W  | 4000K  | 90 lm/watt   | WHITE | 1/20    | 22.65     |
| 5207227060298 | 145-68026 | 24W  | 3000K  | 90 lm/watt   | WHITE | 1/20    | 22.65     |

SURFACE LED SLIM LIGHT FIXTURES • ΦΩΤΙΣΤΙΚΑ ΕΙΩΤΕΡΙΚΑ LED SLIM

**NEW!**

PRODUCTION MATERIAL: **ALUMINIUM & PLASTIC**  
ΥΛΙΚΟ ΚΑΤΑΣΚΕΥΗΣ: **ΑΛΟΥΜΙΝΙΟ & ΠΛΑΣΤΙΚΟ**

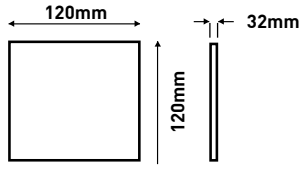
**PLUS**



IP20 NOT DIMMABLE A+ ENERGY CLASS 300mA INSTALLATION HEIGHT 2-3M CLASS II SMD 2835 0.230Kg 2 YEARS GUARANTEE

VOLT 85-265V 50-60Hz flicker free BEAM ANGLE 120° PF >0.5 Ra >80 15000 ON-OFF 30000h LIFE TIME START TIME min: 0.5 sec -10°C ~ +60°C OPERATING TEMP. Color Box PACKING

| BARCODE       | CODE      | WATT | KELVIN | LUMEN / WATT | COLOR | PACKING | PRICE (€) |
|---------------|-----------|------|--------|--------------|-------|---------|-----------|
| 5207227069581 | 145-68520 | 6W   | 6500K  | 90 lm/watt   | WHITE | 1/20    | 7.65      |
| 5207227069604 | 145-68521 | 6W   | 4000K  | 90 lm/watt   | WHITE | 1/20    | 7.65      |
| 5207227069628 | 145-68522 | 6W   | 3000K  | 90 lm/watt   | WHITE | 1/20    | 7.65      |

SURFACE LED SLIM LIGHT FIXTURES • ΦΩΤΙΣΤΙΚΑ ΕΙΩΤΕΡΙΚΑ LED SLIM

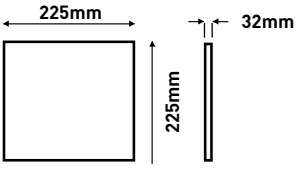
PRODUCTION MATERIAL: **ALUMINIUM & PLASTIC**  
ΥΛΙΚΟ ΚΑΤΑΣΚΕΥΗΣ: **ΑΛΟΥΜΙΝΙΟ & ΠΛΑΣΤΙΚΟ**

**PLUS**



IP20 NOT DIMMABLE A+ ENERGY CLASS 300mA INSTALLATION HEIGHT 2-3M CLASS I SMD 2835 0.550Kg 2 YEARS GUARANTEE

VOLT 85-265V 50-60Hz flicker free BEAM ANGLE 120° PF >0.5 Ra >80 15000 ON-OFF 30000h LIFE TIME START TIME min: 0.5 sec -10°C ~ +60°C OPERATING TEMP. Color Box PACKING

| BARCODE       | CODE      | WATT | KELVIN | LUMEN / WATT | COLOR | PACKING | PRICE (€) |
|---------------|-----------|------|--------|--------------|-------|---------|-----------|
| 5206139026644 | 145-68016 | 20W  | 6500K  | 90 lm/watt   | WHITE | 1/20    | 14.95     |
| 5206139021458 | 145-68017 | 20W  | 4000K  | 90 lm/watt   | WHITE | 1/20    | 14.95     |
| 5206139025210 | 145-68034 | 20W  | 3000K  | 90 lm/watt   | WHITE | 1/20    | 14.95     |

**NEW!**

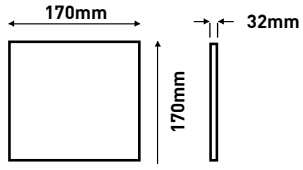
PRODUCTION MATERIAL: **ALUMINIUM & PLASTIC**  
ΥΛΙΚΟ ΚΑΤΑΣΚΕΥΗΣ: **ΑΛΟΥΜΙΝΙΟ & ΠΛΑΣΤΙΚΟ**

**PLUS**

IP20 NOT DIMMABLE A+ ENERGY CLASS 600mA INSTALLATION HEIGHT 2-3M CLASS II SMD 2835 0.340Kg 2 YEARS GUARANTEE

VOLT 85-265V 50-60Hz flicker free BEAM ANGLE 120° PF >0.5 Ra >80 15000 ON-OFF 30000h LIFE TIME START TIME min: 0.5 sec -10°C ~ +60°C OPERATING TEMP. Color Box PACKING

| BARCODE       | CODE      | WATT | KELVIN | LUMEN / WATT | COLOR | PACKING | PRICE (€) |
|---------------|-----------|------|--------|--------------|-------|---------|-----------|
| 5207227069642 | 145-68526 | 12W  | 6500K  | 90 lm/watt   | WHITE | 1/20    | 10.95     |
| 5207227069666 | 145-68527 | 12W  | 4000K  | 90 lm/watt   | WHITE | 1/20    | 10.95     |
| 5207227069680 | 145-68528 | 12W  | 3000K  | 90 lm/watt   | WHITE | 1/20    | 10.95     |

PRODUCTION MATERIAL: **ALUMINIUM & PLASTIC**  
ΥΛΙΚΟ ΚΑΤΑΣΚΕΥΗΣ: **ΑΛΟΥΜΙΝΙΟ & ΠΛΑΣΤΙΚΟ**

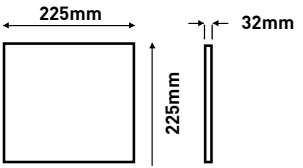
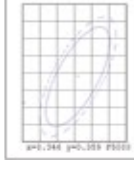
**PLUS**

IP20 NOT DIMMABLE A+ ENERGY CLASS 300mA INSTALLATION HEIGHT 2-3M CLASS I SMD 2835 0.570Kg 2 YEARS GUARANTEE



VOLT 85-265V 50-60Hz flicker free BEAM ANGLE 120° PF >0.5 Ra >80 15000 ON-OFF 30000h LIFE TIME START TIME min: 0.5 sec -10°C ~ +60°C OPERATING TEMP. Color Box PACKING

| BARCODE       | CODE      | WATT | KELVIN | LUMEN / WATT | COLOR | PACKING | PRICE (€) |
|---------------|-----------|------|--------|--------------|-------|---------|-----------|
| 5206139042033 | 145-68027 | 24W  | 6500K  | 90 lm/watt   | WHITE | 1/20    | 18.95     |
| 5206139041067 | 145-68028 | 24W  | 4000K  | 90 lm/watt   | WHITE | 1/20    | 18.95     |

SURFACE LED SLIM LIGHT FIXTURES • ΦΩΤΙΣΤΙΚΑ ΕΞΩΤΕΡΙΚΑ LED SLIM

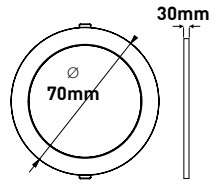

PRODUCTION MATERIAL: **PLASTIC**  
ΥΛΙΚΟ ΚΑΤΑΣΚΕΥΗΣ: **ΠΛΑΣΤΙΚΟ**

**PLUS**  
2 YEARS GUARANTEE

IP20, NOT DIMMABLE, A+ ENERGY CLASS, 125mA, INSTALLATION HEIGHT 2-3M, CLASS II, SMD 2835, 0.030Kg

VOLT: 220-240V 50-60Hz, BEAM ANGLE: 106°, PF: >0.5, Ra: >80, 15000 ON-OFF, 20000h LIFE TIME, START TIME min: 0.5 sec, -20°C ~ +40°C OPERATING TEMP.

| BARCODE       | CODE      | WATT | KELVIN | LUMEN / WATT | COLOR | PACKING | PRICE (€) |
|---------------|-----------|------|--------|--------------|-------|---------|-----------|
| 5207227019227 | 145-68651 | 2W   | 4200K  | 55 lm/watt   | WHITE | 1/100   | 6.15      |
| 5207227019203 | 145-68652 | 2W   | 3000K  | 55 lm/watt   | WHITE | 1/100   | 6.15      |

White Box with Sticker PACKING

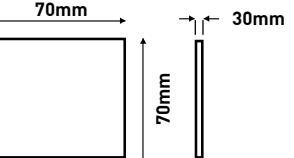
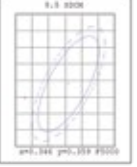

PRODUCTION MATERIAL: **PLASTIC**  
ΥΛΙΚΟ ΚΑΤΑΣΚΕΥΗΣ: **ΠΛΑΣΤΙΚΟ**

**PLUS**  
2 YEARS GUARANTEE

IP20, NOT DIMMABLE, A+ ENERGY CLASS, 125mA, INSTALLATION HEIGHT 2-3M, CLASS II, SMD 2835, 0.040Kg



VOLT: 220-240V 50-60Hz, BEAM ANGLE: 106°, PF: >0.5, Ra: >80, 15000 ON-OFF, 20000h LIFE TIME, START TIME min: 0.5 sec, -20°C ~ +40°C OPERATING TEMP.

| BARCODE       | CODE      | WATT | KELVIN | LUMEN / WATT | COLOR | PACKING | PRICE (€) |
|---------------|-----------|------|--------|--------------|-------|---------|-----------|
| 5207227019265 | 145-68654 | 2W   | 4200K  | 55 lm/watt   | WHITE | 1/100   | 7.35      |
| 5207227019241 | 145-68655 | 2W   | 3000K  | 55 lm/watt   | WHITE | 1/100   | 7.35      |

White Box with Sticker PACKING

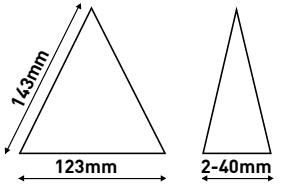

PRODUCTION MATERIAL: **PLASTIC**  
ΥΛΙΚΟ ΚΑΤΑΣΚΕΥΗΣ: **ΠΛΑΣΤΙΚΟ**

**PLUS**  
2 YEARS GUARANTEE

IP20, NOT DIMMABLE, A+ ENERGY CLASS, 125mA, INSTALLATION HEIGHT 2-3M, CLASS II, SMD 2835, 0.050Kg

VOLT: 220-240V 50-60Hz, BEAM ANGLE: 106°, PF: >0.5, Ra: >80, 15000 ON-OFF, 20000h LIFE TIME, START TIME min: 0.5 sec, -20°C ~ +40°C OPERATING TEMP.

| BARCODE       | CODE      | WATT | KELVIN | LUMEN / WATT | COLOR | PACKING | PRICE (€) |
|---------------|-----------|------|--------|--------------|-------|---------|-----------|
| 5207227019289 | 145-68671 | 2W   | 4200K  | 55 lm/watt   | WHITE | 1/100   | 8.65      |
| 5207227019302 | 145-68672 | 2W   | 3000K  | 55 lm/watt   | WHITE | 1/100   | 8.65      |

White Box with Sticker PACKING



Ταινίες LED, Τροφοδοτικά, Controller

για Οικιακή & Επαγγελματική Χρήση

Ιδανικοί για χρήση σε χώρους όπως:

- Κατοικίες
- Καταστήματα
- Εμπορικά Κέντρα
- Αποθήκες
- Βιοτεχνικούς Χώρους
- Βιομηχανικούς Χώρους
- Μοτέλ
- Ξενοδοχεία
- Αίθουσες Διδασκαλίας
- Εκθεσιακούς Χώρους
- Μουσεία
- Αρχιτεκτονικές Δομές
- Δημόσιες Εγκαταστάσεις

LED Tapes, Drivers, Controllers

for Domestic & Professional use

Ideal for use in places as:

- Residences
- Stores
- Shopping Malls
- Warehouses
- Business Areas
- Industrial Areas
- Motels
- Hotels
- Teaching Rooms
- Exhibitions
- Museums
- Architectural Structures
- Public Facilities

LED TAPES • ΤΑΙΝΙΕΣ LED



LED TAPE 3 METRES 6W+DRIVER 12V  
ΤΑΙΝΙΑ LED 3 ΜΕΤΡΩΝ 6W+DRIVER 12V

PRODUCTION MATERIAL: COPPER & PLASTIC  
ΥΛΙΚΟ ΚΑΤΑΣΚΕΥΗΣ: ΧΑΛΚΟΣ & ΠΛΑΣΤΙΚΟ

VALUE

1 YEAR GUARANTEE

Double Blister PACKING

|                   |                   |          |                    |              |                  |                            |                                  |           |
|-------------------|-------------------|----------|--------------------|--------------|------------------|----------------------------|----------------------------------|-----------|
| TAPE LENGTH<br>3m | IP20              | DIMMABLE | A+ ENERGY CLASS    | 660mA        | VOLT<br>12V      | 0.260Kg                    |                                  |           |
| CUTTING<br>50mm   | EXPANDS TO<br>10m | SMD 2835 | BEAM ANGLE<br>120° | Ra >70       | 17000h LIFE TIME | START TIME min:<br>0.5 sec | -20°C ~ +40°C<br>OPERATING TEMP. |           |
| BARCODE           | CODE              | WATT     | KELVIN             | LUMEN / WATT | LED CHIP/m       | WIDTH (mm)                 | PACKING                          | PRICE (€) |
| 5206139077172     | 147-70010         | 6W       | 4000K              | 80 lm/watt   | 60               | 8                          | 1/32                             | 29.85     |



LED TAPE 3 METRES 10W+DRIVER 12V+CONTROL  
ΤΑΙΝΙΑ LED 3 ΜΕΤΡΩΝ 10W+DRIVER 12V+CONTROL

VALUE

1 YEAR GUARANTEE

Double Blister PACKING

|                   |                   |          |                    |                  |                            |                                  |           |
|-------------------|-------------------|----------|--------------------|------------------|----------------------------|----------------------------------|-----------|
| TAPE LENGTH<br>3m | IP20              | DIMMABLE | A+ ENERGY CLASS    | 660mA            | VOLT<br>12V                | 0.280Kg                          |           |
| CUTTING<br>100mm  | EXPANDS TO<br>10m | SMD 5050 | BEAM ANGLE<br>120° | 17000h LIFE TIME | START TIME min:<br>0.5 sec | -20°C ~ +40°C<br>OPERATING TEMP. |           |
| BARCODE           | CODE              | WATT     | KELVIN             | LED CHIP/m       | WIDTH (mm)                 | PACKING                          | PRICE (€) |
| 5206139077219     | 147-70011         | 10W      | RGB                | 30               | 10                         | 1/36                             | 34.85     |

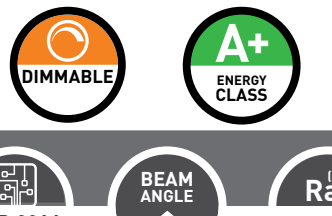

CORNER LED TAPE 5M 12W  
ΤΑΙΝΙΑ ΓΩΝΙΑΚΗ LED 5 ΜΕΤΡΩΝ 12W

PRO

2 YEARS GUARANTEE

SilverBag PACKING

|                   |                   |          |                    |              |                  |                            |                                  |             |
|-------------------|-------------------|----------|--------------------|--------------|------------------|----------------------------|----------------------------------|-------------|
| TAPE LENGTH<br>5m | IP20              | DIMMABLE | A+ ENERGY CLASS    | 916mA        | VOLT<br>12V      | 0.076Kg                    |                                  |             |
| CUTTING<br>25mm   | EXPANDS TO<br>10m | SMD 3014 | BEAM ANGLE<br>120° | Ra >80       | 34000h LIFE TIME | START TIME min:<br>0.5 sec | -20°C ~ +40°C<br>OPERATING TEMP. |             |
| BARCODE           | CODE              | WATT     | KELVIN             | LUMEN / WATT | LED CHIP/m       | WIDTH (mm)                 | PACKING                          | PRICE(€/5m) |
| 5206139029058     | 147-70210         | 12W      | 6500K              | 95 lm/watt   | 120              | 8                          | 1/25/100                         | 94.20       |
| 5206139029171     | 147-70211         | 12W      | 4000K              | 93 lm/watt   | 120              | 8                          | 1/25/100                         | 94.20       |
| 5207227016660     | 147-70212         | 12W      | 3000K              | 90 lm/watt   | 120              | 8                          | 1/25/100                         | 94.20       |

LED TAPES • ΤΑΙΝΙΕΣ LED

LED TAPE 5 METRES  
ΤΑΙΝΙΑ LED 5 ΜΕΤΡΩΝ

PRODUCTION MATERIAL: COPPER & PLASTIC  
ΥΛΙΚΟ ΚΑΤΑΣΚΕΥΗΣ: ΧΑΛΚΟΣ & ΠΛΑΣΤΙΚΟ

VALUE

1 YEAR GUARANTEE

SilverBag PACKING

|                   |                   |          |                    |              |                  |                            |                                  |             |
|-------------------|-------------------|----------|--------------------|--------------|------------------|----------------------------|----------------------------------|-------------|
| TAPE LENGTH<br>5m | IP20              | DIMMABLE | A ENERGY CLASS     | 400mA        | VOLT<br>12V      | 0.090Kg                    |                                  |             |
| CUTTING<br>50mm   | EXPANDS TO<br>10m | SMD 3528 | BEAM ANGLE<br>120° | Ra >70       | 17000h LIFE TIME | START TIME min:<br>0.5 sec | -20°C ~ +40°C<br>OPERATING TEMP. |             |
| BARCODE           | CODE              | WATT     | KELVIN             | LUMEN / WATT | LED CHIP/m       | WIDTH (mm)                 | PACKING                          | PRICE(€/1m) |
| 5206139028938     | 145-70100         | 4,8W     | 6500K              | 70lm/watt    | 60               | 8                          | 1/100                            | 2.95        |
| 5206139028990     | 145-70101         | 4,8W     | 3000K              | 70lm/watt    | 60               | 8                          | 1/100                            | 2.95        |

NEW!

VALUE

1 YEAR GUARANTEE

SilverBag PACKING

|                   |                   |          |                    |              |                  |                            |                                  |              |
|-------------------|-------------------|----------|--------------------|--------------|------------------|----------------------------|----------------------------------|--------------|
| TAPE LENGTH<br>5m | IP20              | DIMMABLE | A ENERGY CLASS     | 480mA        | VOLT<br>12V      | 0.120Kg                    |                                  |              |
| CUTTING<br>100mm  | EXPANDS TO<br>10m | SMD 5050 | BEAM ANGLE<br>120° | Ra >70       | 17000h LIFE TIME | START TIME min:<br>0.5 sec | -20°C ~ +40°C<br>OPERATING TEMP. |              |
| BARCODE           | CODE              | WATT     | KELVIN             | LUMEN / WATT | LED CHIP/m       | WIDTH (mm)                 | PACKING                          | PRICE (€/1m) |
| 5207227066436     | 145-70110         | 7,2W     | 6500K              | 65 lm/watt   | 30               | 10                         | 1/25/100                         | 2.68         |
| 5207227066467     | 145-70111         | 7,2W     | 4000K              | 65 lm/watt   | 30               | 10                         | 1/25/100                         | 2.68         |
| 5207227066498     | 145-70112         | 7,2W     | 3000K              | 65 lm/watt   | 30               | 10                         | 1/25/100                         | 2.68         |
| 5207227067303     | 145-70113         | 7,2W     | RGB                | -            | 30               | 10                         | 1/25/100                         | K.E.         |

PLUS

2 YEARS GUARANTEE

SilverBag PACKING

|                   |                   |          |                    |              |                  |                            |                                  |              |
|-------------------|-------------------|----------|--------------------|--------------|------------------|----------------------------|----------------------------------|--------------|
| TAPE LENGTH<br>5m | IP20              | DIMMABLE | A ENERGY CLASS     | 600mA        | VOLT<br>12V      | 0.130Kg                    |                                  |              |
| CUTTING<br>100mm  | EXPANDS TO<br>10m | SMD 5050 | BEAM ANGLE<br>120° | Ra >80       | 25000h LIFE TIME | START TIME min:<br>0.5 sec | -20°C ~ +40°C<br>OPERATING TEMP. |              |
| BARCODE           | CODE              | WATT     | KELVIN             | LUMEN / WATT | LED CHIP/m       | WIDTH (mm)                 | PACKING                          | PRICE (€/1m) |
| 5207227066528     | 145-70120         | 7,2W     | 6500K              | 95 lm/watt   | 30               | 10                         | 1/25/100                         | 4.85         |
| 5207227066559     | 145-70121         | 7,2W     | 4000K              | 93 lm/watt   | 30               | 10                         | 1/25/100                         | 4.85         |
| 5207227066580     | 145-70122         | 7,2W     | 3000K              | 90 lm/watt   | 30               | 10                         | 1/25/100                         | 4.85         |
| 5207227066610     | 145-70123         | 7,2W     | RGB                | -            | 30               | 10                         | 1/25/100                         | 5.15         |

LED TAPES • ΤΑΙΝΙΕΣ LED



LED TAPE 5 METRES  
ΤΑΙΝΙΑ LED 5 ΜΕΤΡΩΝ

PRO  
PRODUCTION MATERIAL: COPPER & PLASTIC  
ΥΛΙΚΟ ΚΑΤΑΣΚΕΥΗΣ: ΧΑΛΚΟΣ & ΠΛΑΣΤΙΚΟ



TAPE LENGTH 5m, IP20, DIMMABLE, ENERGY CLASS A, 830mA 1.2A\*, VOLT 12V, 0.080kg 0.150kg\*, CUTTING 50mm, EXPANDS TO 10m, SMD 2835 SMD 5050\*, BEAM ANGLE 120°, Ra >80, 25000h LIFE TIME, START TIME min: 0.5 sec, -20°C ~ +40°C OPERATING TEMP., SilverBag PACKING

| BARCODE       | CODE       | WATT | KELVIN | LUMEN / WATT | LED CHIP/m | WIDTH (mm) | PACKING  | PRICE (€)/1m |
|---------------|------------|------|--------|--------------|------------|------------|----------|--------------|
| 5206139055774 | 145-70130  | 10W  | 6500K  | 105 lm/watt  | 60         | 8          | 1/25/100 | 5.05         |
| 5206139055781 | 145-70131  | 10W  | 4000K  | 103 lm/watt  | 60         | 8          | 1/25/100 | 5.05         |
| 5206139055798 | 145-70132  | 10W  | 3000K  | 100 lm/watt  | 60         | 8          | 1/25/100 | 5.05         |
| 5206139055804 | 145-70133  | 10W  | RED    | -            | 60         | 8          | 1/25/100 | 5.05         |
| 5206139055811 | 145-70134  | 10W  | GREEN  | -            | 60         | 8          | 1/25/100 | 5.05         |
| 5206139055835 | 145-70135  | 10W  | BLUE   | -            | 60         | 8          | 1/25/100 | 5.05         |
| 5206139055842 | 145-70136  | 10W  | YELLOW | -            | 60         | 8          | 1/25/100 | 5.05         |
| 5206139008411 | 145-70137* | 10W  | RGB*   | -            | 60         | 10         | 1/25/100 | 9.35         |



LED TAPE 30 METRES  
ΤΑΙΝΙΑ LED 30 ΜΕΤΡΩΝ

PRO  
PRODUCTION MATERIAL: COPPER & PLASTIC  
ΥΛΙΚΟ ΚΑΤΑΣΚΕΥΗΣ: ΧΑΛΚΟΣ & ΠΛΑΣΤΙΚΟ

TAPE LENGTH 30m, IP20, DIMMABLE, ENERGY CLASS A, 830mA 1.2A\*, VOLT 12V, 0.550kg 0.950kg\*, CUTTING 50mm, EXPANDS TO 10m, SMD 2835 SMD 5050\*, BEAM ANGLE 120°, Ra >80, 25000h LIFE TIME, START TIME min: 0.5 sec, -20°C ~ +40°C OPERATING TEMP., SilverBag PACKING

| BARCODE       | CODE       | WATT | KELVIN | LUMEN / WATT | LED CHIP/m | WIDTH (mm) | PACKING | PRICE (€)/1m |
|---------------|------------|------|--------|--------------|------------|------------|---------|--------------|
| 5207227016820 | 145-70140  | 10W  | 6500K  | 105 lm/watt  | 60         | 8          | 1/25    | 5.05         |
| 5207227016844 | 145-70141  | 10W  | 4000K  | 103 lm/watt  | 60         | 8          | 1/25    | 5.05         |
| 5207227016851 | 145-70142  | 10W  | 3000K  | 100 lm/watt  | 60         | 8          | 1/25    | 5.05         |
| 5207227016875 | 145-70143* | 10W  | RGB*   | -            | 60         | 10         | 1/25    | 9.35         |

LED TAPES • ΤΑΙΝΙΕΣ LED



LED TAPE 5 METRES  
ΤΑΙΝΙΑ LED 5 ΜΕΤΡΩΝ

VALUE  
PRODUCTION MATERIAL: COPPER & PLASTIC  
ΥΛΙΚΟ ΚΑΤΑΣΚΕΥΗΣ: ΧΑΛΚΟΣ & ΠΛΑΣΤΙΚΟ

TAPE LENGTH 5m, IP20, DIMMABLE, ENERGY CLASS A, 1050mA, VOLT 12V, 0.140Kg, CUTTING 50mm, EXPANDS TO 10m, SMD 5050, BEAM ANGLE 120°, Ra >70, 17000h LIFE TIME, START TIME min: 0.5 sec, -20°C ~ +40°C OPERATING TEMP., SilverBag PACKING

| BARCODE       | CODE      | WATT  | KELVIN | LUMEN / WATT | LED CHIP/m | WIDTH (mm) | PACKING | PRICE (€)/1m |
|---------------|-----------|-------|--------|--------------|------------|------------|---------|--------------|
| 5207227067372 | 145-70150 | 14,4W | 6500K  | 65 lm/watt   | 60         | 10         | 1/100   | 2.85         |
| 5207227067389 | 145-70151 | 14,4W | 4000K  | 65 lm/watt   | 60         | 10         | 1/100   | 2.85         |
| 5207227067396 | 145-70152 | 14,4W | 3000K  | 65 lm/watt   | 60         | 10         | 1/100   | 2.85         |
| 5207227067402 | 145-70157 | 14,4W | RGB    | -            | 60         | 10         | 1/100   | 3.45         |



LED TAPE 5 METRES  
ΤΑΙΝΙΑ LED 5 ΜΕΤΡΩΝ

PLUS  
PRODUCTION MATERIAL: COPPER & PLASTIC  
ΥΛΙΚΟ ΚΑΤΑΣΚΕΥΗΣ: ΧΑΛΚΟΣ & ΠΛΑΣΤΙΚΟ

TAPE LENGTH 5m, IP20, DIMMABLE, ENERGY CLASS A, 1200mA, VOLT 12V, 0.150Kg, CUTTING 50mm, EXPANDS TO 10m, SMD 5050, BEAM ANGLE 120°, Ra >80, 25000h LIFE TIME, START TIME min: 0.5 sec, -20°C ~ +40°C OPERATING TEMP., SilverBag PACKING

| BARCODE       | CODE      | WATT  | KELVIN | LUMEN / WATT | LED CHIP/m | WIDTH (mm) | PACKING | PRICE (€)/1m |
|---------------|-----------|-------|--------|--------------|------------|------------|---------|--------------|
| 5206139029232 | 145-70160 | 14,4W | 6500K  | 95 lm/watt   | 60         | 10         | 1/100   | 6.25         |
| 5206139029294 | 145-70161 | 14,4W | 4000K  | 93 lm/watt   | 60         | 10         | 1/100   | 6.25         |
| 5206139011992 | 145-70162 | 14,4W | 3000K  | 90 lm/watt   | 60         | 10         | 1/100   | 6.25         |
| 5207227010903 | 145-70167 | 14,4W | RGB    | -            | 60         | 10         | 1/100   | 6.85         |

**NEW!**

**LED TAPE 5 METRES  
ΤΑΙΝΙΑ LED 5 ΜΕΤΡΩΝ**

PRODUCTION MATERIAL: **COPPER & PLASTIC**  
ΥΛΙΚΟ ΚΑΤΑΣΚΕΥΗΣ: **ΧΑΛΚΟΣ & ΠΛΑΣΤΙΚΟ**



**VALUE**

TAPE LENGTH 5m, IP20, DIMMABLE, ENERGY CLASS A, 300mA, VOLT 24V, 0.120Kg

CUTTING 100mm, EXPANDS TO 20m, SMD 5050, BEAM ANGLE 120°, Ra >70, 17000h LIFE TIME, START TIME min: 0.5 sec, -20°C ~ +40°C OPERATING TEMP.

SilverBag PACKING

| BARCODE       | CODE      | WATT | KELVIN | LUMEN / WATT | LED CHIP/m | WIDTH (mm) | PACKING | PRICE (€)/1m |
|---------------|-----------|------|--------|--------------|------------|------------|---------|--------------|
| 5207227069734 | 145-70210 | 7,2W | 6500K  | 65 lm/watt   | 30         | 10         | 1/100   | 2.68         |
| 5207227069741 | 145-70211 | 7,2W | 4000K  | 65 lm/watt   | 30         | 10         | 1/100   | 2.68         |
| 5207227069758 | 145-70212 | 7,2W | 3000K  | 65 lm/watt   | 30         | 10         | 1/100   | 2.68         |
| 5207227069765 | 145-70217 | 7,2W | RGB    | -            | 30         | 10         | 1/100   | K.E.         |

**NEW!**

**LED TAPE 5 METRES  
ΤΑΙΝΙΑ LED 5 ΜΕΤΡΩΝ**

PRODUCTION MATERIAL: **COPPER & PLASTIC**  
ΥΛΙΚΟ ΚΑΤΑΣΚΕΥΗΣ: **ΧΑΛΚΟΣ & ΠΛΑΣΤΙΚΟ**



**PLUS**

TAPE LENGTH 5m, IP20, DIMMABLE, ENERGY CLASS A, 500mA, VOLT 24V, 0.130Kg

CUTTING 100mm, EXPANDS TO 20m, SMD 5050, BEAM ANGLE 120°, Ra >80, 25000h LIFE TIME, START TIME min: 0.5 sec, -20°C ~ +40°C OPERATING TEMP.

SilverBag PACKING

| BARCODE       | CODE      | WATT | KELVIN | LUMEN / WATT | LED CHIP/m | WIDTH (mm) | PACKING | PRICE (€)/1m |
|---------------|-----------|------|--------|--------------|------------|------------|---------|--------------|
| 5207227069772 | 145-70220 | 7,2W | 6500K  | 95 lm/watt   | 30         | 10         | 1/100   | 4.85         |
| 5207227069789 | 145-70221 | 7,2W | 4000K  | 93 lm/watt   | 30         | 10         | 1/100   | 4.85         |
| 5207227069796 | 145-70222 | 7,2W | 3000K  | 90 lm/watt   | 30         | 10         | 1/100   | 4.85         |
| 5207227069802 | 145-70227 | 7,2W | RGB    | -            | 30         | 10         | 1/100   | 5.15         |

**NEW!**

**LED TAPE 5 METRES  
ΤΑΙΝΙΑ LED 5 ΜΕΤΡΩΝ**

PRODUCTION MATERIAL: **COPPER & PLASTIC**  
ΥΛΙΚΟ ΚΑΤΑΣΚΕΥΗΣ: **ΧΑΛΚΟΣ & ΠΛΑΣΤΙΚΟ**



**PRO**

TAPE LENGTH 5m, IP20, DIMMABLE, ENERGY CLASS A, 600mA, VOLT 24V, 0.105Kg

CUTTING 50mm, EXPANDS TO 20m, SMD 2835, BEAM ANGLE 120°, Ra >80, 25000h LIFE TIME, START TIME min: 0.5 sec, -20°C ~ +40°C OPERATING TEMP.

SilverBag PACKING

| BARCODE       | CODE      | WATT | KELVIN | LUMEN / WATT | LED CHIP/m | WIDTH (mm) | PACKING | PRICE (€)/1m |
|---------------|-----------|------|--------|--------------|------------|------------|---------|--------------|
| 5207227067037 | 145-70230 | 9,6W | 6500K  | 125 lm/watt  | 120        | 8          | 1/100   | 6.25         |
| 5207227067068 | 145-70231 | 9,6W | 4000K  | 123 lm/watt  | 120        | 8          | 1/100   | 6.25         |
| 5207227067099 | 145-70232 | 9,6W | 3000K  | 120 lm/watt  | 120        | 8          | 1/100   | 6.25         |

**NEW!**

**LED TAPE 5 METRES FLEXIBLE  
ΤΑΙΝΙΑ LED 5 ΜΕΤΡΩΝ FLEXIBLE**

PRODUCTION MATERIAL: **COPPER & PLASTIC**  
ΥΛΙΚΟ ΚΑΤΑΣΚΕΥΗΣ: **ΧΑΛΚΟΣ & ΠΛΑΣΤΙΚΟ**



**PRO**

TAPE LENGTH 5m, IP20, DIMMABLE, ENERGY CLASS A, 410mA, VOLT 24V, 0.080Kg

CUTTING 50mm, EXPANDS TO 20m, SMD 2835, BEAM ANGLE 120°, Ra >80, 25000h LIFE TIME, START TIME min: 0.5 sec, -20°C ~ +40°C OPERATING TEMP.

SilverBag PACKING

| BARCODE       | CODE      | WATT | KELVIN | LUMEN / WATT | LED CHIP/m | WIDTH (mm) | PACKING | PRICE (€)/1m |
|---------------|-----------|------|--------|--------------|------------|------------|---------|--------------|
| 5207227066641 | 145-70235 | 10W  | 6500K  | 105 lm/watt  | 60         | 8          | 1/100   | 4.25         |
| 5207227066672 | 145-70236 | 10W  | 4000K  | 103 lm/watt  | 60         | 8          | 1/100   | 4.25         |
| 5207227066702 | 145-70237 | 10W  | 3000K  | 100 lm/watt  | 60         | 8          | 1/100   | 4.25         |



**LED TAPE 5 METRES  
ΤΑΙΝΙΑ LED 5 ΜΕΤΡΩΝ**

PRO  
PRODUCTION MATERIAL: **COPPER & PLASTIC**  
ΥΛΙΚΟ ΚΑΤΑΣΚΕΥΗΣ: **ΧΑΛΚΟΣ & ΠΛΑΣΤΙΚΟ**

TAPE LENGTH 5m | IP20 | DIMMABLE | ENERGY CLASS A | VOLT 24V | WATT 10W | 410mA 1200mA+ | 0.080Kg 0.150Kg

CUTTING 50mm | EXPANDS TO 20m | SMD 2835 SMD 5050\* | BEAM ANGLE 120° | Ra >80 | 25000h LIFE TIME | START TIME min: 0.5 sec | -20°C ~ +40°C OPERATING TEMP. | SilverBag PACKING

| BARCODE       | CODE       | WATT | KELVIN  | LUMEN / WATT | LED CHIP/m | WIDTH (mm) | PACKING | PRICE (€)/1m |
|---------------|------------|------|---------|--------------|------------|------------|---------|--------------|
| 5206139081087 | 145-70240  | 10W  | 6500K   | 105lm/watt   | 60         | 8          | 1/100   | 5.05         |
| 5206139081162 | 145-70241  | 10W  | 4000K   | 103lm/watt   | 60         | 8          | 1/100   | 5.05         |
| 5206139081179 | 145-70242  | 10W  | 3000K   | 100lm/watt   | 60         | 8          | 1/100   | 5.05         |
| 5206139081186 | 145-70243* | 10W  | RGB     | -            | 60         | 10         | 1/100   | 9.35         |
| 5207227067150 | 145-70244* | 10W  | RGBW    | -            | 60         | 12         | 1/100   | 14.25        |
| 5207227069819 | 145-70245* | 10W  | RGBWW   | -            | 60         | 12         | 1/100   | 14.25        |
| 5207227069826 | 145-70246* | 10W  | RGB CCT | -            | 60         | 12         | 1/100   | K.E.         |



**LED TAPE 5 METRES  
ΤΑΙΝΙΑ LED 5 ΜΕΤΡΩΝ**

VALUE  
PRODUCTION MATERIAL: **COPPER & PLASTIC**  
ΥΛΙΚΟ ΚΑΤΑΣΚΕΥΗΣ: **ΧΑΛΚΟΣ & ΠΛΑΣΤΙΚΟ**

TAPE LENGTH 5m | IP20 | DIMMABLE | ENERGY CLASS A | 600mA | VOLT 24V | 0.145Kg

CUTTING 50mm | EXPANDS TO 10m | SMD 5050 | BEAM ANGLE 120° | Ra >70 | 17000h LIFE TIME | START TIME min: 0.5 sec | -20°C ~ +40°C OPERATING TEMP. | SilverBag PACKING

| BARCODE       | CODE      | WATT  | KELVIN | LUMEN / WATT | LED CHIP/m | WIDTH (mm) | PACKING  | PRICE (€)/1m |
|---------------|-----------|-------|--------|--------------|------------|------------|----------|--------------|
| 5207227066733 | 145-70250 | 14,4W | 6500K  | 65 lm/watt   | 60         | 10         | 1/25/100 | 2.85         |
| 5207227066764 | 145-70251 | 14,4W | 4000K  | 65 lm/watt   | 60         | 10         | 1/25/100 | 2.85         |
| 5207227066795 | 145-70252 | 14,4W | 3000K  | 65 lm/watt   | 60         | 10         | 1/25/100 | 2.85         |
| 5207227066825 | 145-70253 | 14,4W | RGB    | -            | 60         | 10         | 1/25/100 | 3.45         |



**LED TAPE 5 METRES COB  
ΤΑΙΝΙΑ LED 5 ΜΕΤΡΩΝ COB**

PRO  
PRODUCTION MATERIAL: **COPPER & PLASTIC**  
ΥΛΙΚΟ ΚΑΤΑΣΚΕΥΗΣ: **ΧΑΛΚΟΣ & ΠΛΑΣΤΙΚΟ**

TAPE LENGTH 5m | IP20 | DIMMABLE | ENERGY CLASS A | 500mA | VOLT 24V | 0.100Kg

CUTTING 62.5mm | EXPANDS TO 5m | COB | BEAM ANGLE 120° | Ra >90 | 35000h LIFE TIME | START TIME min: 0.5 sec | -20°C ~ +40°C OPERATING TEMP. | SilverBag PACKING

| BARCODE       | CODE      | WATT | KELVIN | LUMEN / WATT | LED CHIP/m | WIDTH (mm) | PACKING | PRICE (€)/1m |
|---------------|-----------|------|--------|--------------|------------|------------|---------|--------------|
| 5207227068621 | 145-70050 | 12W  | 6500K  | 125 lm/watt  | 512        | 8          | 1/100   | 28.80        |
| 5207227068645 | 145-70051 | 12W  | 4000K  | 122 lm/watt  | 512        | 8          | 1/100   | 28.80        |
| 5207227068669 | 145-70052 | 12W  | 3000K  | 120 lm/watt  | 512        | 8          | 1/100   | 28.80        |



**LED TAPE 5 METRES  
ΤΑΙΝΙΑ LED 5 ΜΕΤΡΩΝ**

PLUS  
PRODUCTION MATERIAL: **COPPER & PLASTIC**  
ΥΛΙΚΟ ΚΑΤΑΣΚΕΥΗΣ: **ΧΑΛΚΟΣ & ΠΛΑΣΤΙΚΟ**

TAPE LENGTH 5m | IP20 | DIMMABLE | ENERGY CLASS A | 1200mA | VOLT 24V | 0.150Kg

CUTTING 50mm | EXPANDS TO 20m | SMD 5050 | BEAM ANGLE 120° | Ra >80 | 25000h LIFE TIME | START TIME min: 0.5 sec | -20°C ~ +40°C OPERATING TEMP. | SilverBag PACKING

| BARCODE       | CODE      | WATT  | KELVIN | LUMEN / WATT | LED CHIP/m | WIDTH (mm) | PACKING | PRICE (€)/1m |
|---------------|-----------|-------|--------|--------------|------------|------------|---------|--------------|
| 5206139033208 | 145-70260 | 14,4W | 6500K  | 95 lm/watt   | 60         | 10         | 1/100   | 6.25         |
| 5206139033260 | 145-70261 | 14,4W | 4000K  | 93 lm/watt   | 60         | 10         | 1/100   | 6.25         |
| 5207227010965 | 145-70262 | 14,4W | 3000K  | 90 lm/watt   | 60         | 10         | 1/100   | 6.25         |
| 5207227010989 | 145-70263 | 14,4W | RGB    | -            | 60         | 10         | 1/100   | 6.85         |

LED TAPES • ΤΑΙΝΙΕΣ LED



LED TAPE 5 METRES  
ΤΑΙΝΙΑ LED 5 ΜΕΤΡΩΝ

PRODUCTION MATERIAL: **COPPER & PLASTIC**  
ΥΛΙΚΟ ΚΑΤΑΣΚΕΥΗΣ: **ΧΑΛΚΟΣ & ΠΛΑΣΤΙΚΟ**

TAPE LENGTH 5m | IP20 | DIMMABLE | ENERGY CLASS A | 500mA | VOLT 24V | 0.100Kg | 2 YEARS WARRANTY | SilverBag PACKING

CUTTING 25mm | EXPANDS TO 20m | SMD 2835 | BEAM ANGLE 120° | Ra >80 | 25000h LIFE TIME | START TIME min: 0.5 sec | -20°C ~ +40°C OPERATING TEMP.

| BARCODE       | CODE      | WATT | KELVIN | LUMEN / WATT | LED CHIP/m | WIDTH (mm) | PACKING | PRICE (€)/1m |
|---------------|-----------|------|--------|--------------|------------|------------|---------|--------------|
| 5207227066856 | 145-70270 | 12W  | 6500K  | 95 lm/watt   | 120        | 8          | 1/100   | 8.25         |
| 5207227066887 | 145-70271 | 12W  | 4000K  | 93 lm/watt   | 120        | 8          | 1/100   | 8.25         |
| 5207227066917 | 145-70272 | 12W  | 3000K  | 90 lm/watt   | 120        | 8          | 1/100   | 8.25         |

LED TAPES • ΤΑΙΝΙΕΣ LED



LED TAPE 5 METRES  
ΤΑΙΝΙΑ LED 5 ΜΕΤΡΩΝ

PRODUCTION MATERIAL: **COPPER & PLASTIC**  
ΥΛΙΚΟ ΚΑΤΑΣΚΕΥΗΣ: **ΧΑΛΚΟΣ & ΠΛΑΣΤΙΚΟ**

TAPE LENGTH 5m | IP54 | DIMMABLE | ENERGY CLASS A | 830mA 1200mA\* | VOLT 12V | 0.180Kg 0.195Kg | 2 YEARS WARRANTY | SilverBag PACKING

CUTTING 50mm | EXPANDS TO 10m | SMD 2835 SMD 5050\* | BEAM ANGLE 120° | Ra >80 | 25000h LIFE TIME | START TIME min: 0.5 sec | -20°C ~ +40°C OPERATING TEMP.

| BARCODE       | CODE       | WATT | KELVIN | LUMEN / WATT | LED CHIP/m | WIDTH (mm) | PACKING | PRICE (€)/1m |
|---------------|------------|------|--------|--------------|------------|------------|---------|--------------|
| 5206139050250 | 145-70310  | 10W  | 6500K  | 105 lm/watt  | 60         | 8          | 1/50    | 5.65         |
| 5206139050946 | 145-70311  | 10W  | 4000K  | 103 lm/watt  | 60         | 8          | 1/50    | 5.65         |
| 5206139050960 | 145-70312  | 10W  | 3000K  | 100 lm/watt  | 60         | 8          | 1/50    | 5.65         |
| 5206139008909 | 145-70313* | 10W  | RGB*   | -            | 60         | 8          | 1/50    | 9.85         |



LED TAPE 5 METRES  
ΤΑΙΝΙΑ LED 5 ΜΕΤΡΩΝ

PRODUCTION MATERIAL: **COPPER & PLASTIC**  
ΥΛΙΚΟ ΚΑΤΑΣΚΕΥΗΣ: **ΧΑΛΚΟΣ & ΠΛΑΣΤΙΚΟ**

TAPE LENGTH 5m | IP20 | DIMMABLE | ENERGY CLASS A | 1000mA | VOLT 24V | 0.160Kg | 2 YEARS WARRANTY | SilverBag PACKING

CUTTING 14.3mm | EXPANDS TO 10m | SMD 2110 | BEAM ANGLE 120° | Ra >90 | 30000h LIFE TIME | START TIME min: 0.5 sec | -20°C ~ +40°C OPERATING TEMP.

| BARCODE       | CODE      | WATT | KELVIN | LUMEN / WATT | LED CHIP/m | WIDTH (mm) | PACKING | PRICE (€)/1m |
|---------------|-----------|------|--------|--------------|------------|------------|---------|--------------|
| 5207227066948 | 145-70280 | 24W  | 6500K  | 100 lm/watt  | 700        | 12         | 1/100   | 42.80        |
| 5207227066979 | 145-70281 | 24W  | 4000K  | 95 lm/watt   | 700        | 12         | 1/100   | 42.80        |
| 5207227067006 | 145-70282 | 24W  | 3000K  | 90 lm/watt   | 700        | 12         | 1/100   | 42.80        |



LED TAPE 5 METRES  
ΤΑΙΝΙΑ LED 5 ΜΕΤΡΩΝ

PRODUCTION MATERIAL: **COPPER & PLASTIC**  
ΥΛΙΚΟ ΚΑΤΑΣΚΕΥΗΣ: **ΧΑΛΚΟΣ & ΠΛΑΣΤΙΚΟ**

TAPE LENGTH 5m | IP54 | DIMMABLE | ENERGY CLASS A | 830mA 1200mA\* | VOLT 24V | 0.180Kg 0.195Kg | 2 YEARS WARRANTY | SilverBag PACKING

CUTTING 50mm | EXPANDS TO 20m | SMD 2835 SMD 5050\* | BEAM ANGLE 120° | Ra >80 | 25000h LIFE TIME | START TIME min: 0.5 sec | -20°C ~ +40°C OPERATING TEMP.

| BARCODE       | CODE       | WATT | KELVIN | LUMEN / WATT | LED CHIP/m | WIDTH (mm) | PACKING | PRICE (€)/1m |
|---------------|------------|------|--------|--------------|------------|------------|---------|--------------|
| 5206139050984 | 145-70350  | 10W  | 6500K  | 105 lm/watt  | 60         | 8          | 1/50    | 5.65         |
| 5206139050991 | 145-70351  | 10W  | 4000K  | 103 lm/watt  | 60         | 8          | 1/50    | 5.65         |
| 5206139051066 | 145-70352  | 10W  | 3000K  | 100 lm/watt  | 60         | 8          | 1/50    | 5.65         |
| 5206139701862 | 145-70353* | 10W  | RGB*   | -            | 60         | 10         | 1/50    | 9.85         |



**LED TAPE 5 METRES  
ΤΑΙΝΙΑ LED 5 ΜΕΤΡΩΝ**

PRODUCTION MATERIAL: **COPPER & PLASTIC**  
ΥΛΙΚΟ ΚΑΤΑΣΚΕΥΗΣ: **ΧΑΛΚΟΣ & ΠΛΑΣΤΙΚΟ**

| BARCODE       | CODE       | WATT | KELVIN | LUMEN / WATT | LED CHIP/m | WIDTH (mm) | PACKING | PRICE (€)/1m |
|---------------|------------|------|--------|--------------|------------|------------|---------|--------------|
| 5207227005503 | 145-70410  | 10W  | 6500K  | 105 lm/watt  | 60         | 11         | 1/50    | 9.85         |
| 5207227005510 | 145-70411  | 10W  | 4000K  | 103 lm/watt  | 60         | 11         | 1/50    | 9.85         |
| 5207227005527 | 145-70412  | 10W  | 3000K  | 100 lm/watt  | 60         | 11         | 1/50    | 9.85         |
| 5207227005534 | 145-70413* | 10W  | RGB*   | -            | 60         | 11         | 1/50    | 14.90        |
| 5207227005541 | 145-70414* | 10W  | RGBW*  | -            | 60         | 11         | 1/50    | 19.15        |
| 5207227005558 | 145-70415* | 10W  | RGBWW* | -            | 60         | 11         | 1/50    | 19.15        |



**LED TAPE 5 METRES  
ΤΑΙΝΙΑ LED 5 ΜΕΤΡΩΝ**

PRODUCTION MATERIAL: **COPPER & PLASTIC**  
ΥΛΙΚΟ ΚΑΤΑΣΚΕΥΗΣ: **ΧΑΛΚΟΣ & ΠΛΑΣΤΙΚΟ**

| BARCODE       | CODE      | WATT | KELVIN | LUMEN / WATT | LED CHIP/m | WIDTH (mm) | PACKING | PRICE (€)/1m |
|---------------|-----------|------|--------|--------------|------------|------------|---------|--------------|
| 5207227067181 | 145-70430 | 20W  | 6500K  | 90 lm/watt   | 120        | 10         | 1/25/50 | 16.25        |
| 5207227005954 | 145-70431 | 20W  | 4000K  | 90 lm/watt   | 120        | 10         | 1/25/50 | 16.25        |
| 5207227005589 | 145-70432 | 20W  | 3000K  | 90 lm/watt   | 120        | 10         | 1/25/50 | 16.25        |



**LED TAPE 10 METRES  
ΤΑΙΝΙΑ LED 10 ΜΕΤΡΩΝ**

PRODUCTION MATERIAL: **COPPER & PLASTIC**  
ΥΛΙΚΟ ΚΑΤΑΣΚΕΥΗΣ: **ΧΑΛΚΟΣ & ΠΛΑΣΤΙΚΟ**

| BARCODE       | CODE      | WATT  | KELVIN | LUMEN / WATT | LED CHIP/m | WIDTH (mm) | PACKING | PRICE (€)/1m |
|---------------|-----------|-------|--------|--------------|------------|------------|---------|--------------|
| 5206139033321 | 145-70450 | 14,4W | 6500K  | 112 lm/watt  | 180        | 15         | 1/10    | 7.85         |
| 5206139032362 | 145-70451 | 14,4W | 4000K  | 110 lm/watt  | 180        | 15         | 1/10    | 7.85         |
| 5207227013218 | 145-70452 | 14,4W | 3000K  | 100 lm/watt  | 180        | 15         | 1/10    | 7.85         |

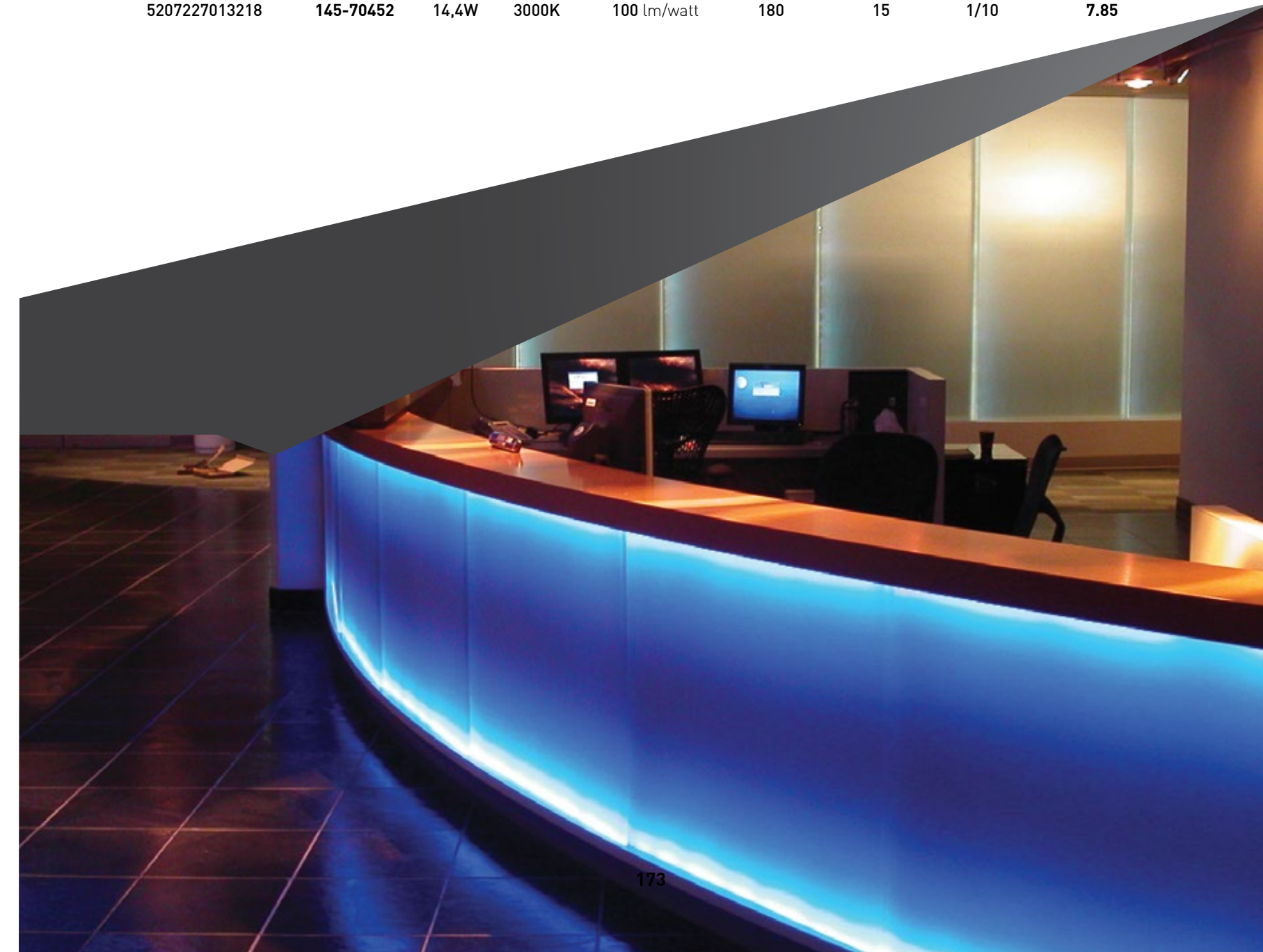

DIMMERS / CONTROLLERS FOR LED TAPES •  
DIMMERS / CONTROLLERS ΓΙΑ ΤΑΙΝΙΕΣ LED



147-70620      147-70621      147-70622

**DIMMER RECESSED FOR LED TAPE**  
**DIMMER ΧΩΝΕΥΤΟ ΓΙΑ ΤΑΙΝΙΑ LED**

PRODUCTION MATERIAL: **PP & FPC**  
ΥΛΙΚΟ ΚΑΤΑΣΚΕΥΗΣ: **PP & FPC**



**Brown Box**  
PACKING



| BARCODE       | CODE      | TYPE         | WATT     | PACKING | PRICE (€) |
|---------------|-----------|--------------|----------|---------|-----------|
| 5206139077349 | 147-70620 | NORMAL       | 180-360W | 1/100   | 56.45     |
| 5206139077370 | 147-70621 | CCT / 2 CH   | 180-360W | 1/100   | 58.30     |
| 5206139077394 | 147-70622 | RGBWW / 5 CH | 180-360W | 1/100   | 58.30     |



147-70630      147-70631

**WIRELESS CONTROLLER Wifi**  
**ΑΣΥΡΜΑΤΟ CONTROLLER Wifi**

PRODUCTION MATERIAL: **PP & FPC**  
ΥΛΙΚΟ ΚΑΤΑΣΚΕΥΗΣ: **PP & FPC**



**Plastic Bag**  
PACKING

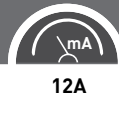

| BARCODE       | CODE      | TYPE | WATT     | WEIGHT  | PACKING | PRICE (€) |
|---------------|-----------|------|----------|---------|---------|-----------|
| 5207227017230 | 147-70630 | RGB  | 120-240W | 0.075kg | 1/100   | 49.60     |
| 5207227017254 | 147-70631 | RGB  | 120-240W | 0.025kg | 1/100   | 35.60     |



147-70632      147-70633

**WIRELESS CONTROLLER RF Wifi**  
**ΑΣΥΡΜΑΤΟ CONTROLLER RF Wifi**

PRODUCTION MATERIAL: **PP & FPC**  
ΥΛΙΚΟ ΚΑΤΑΣΚΕΥΗΣ: **PP & FPC**



**Plastic Bag**  
PACKING

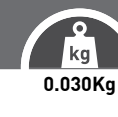
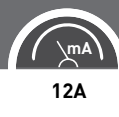
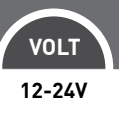

| BARCODE       | CODE      | TYPE    | WATT     | PACKING | PRICE (€) |
|---------------|-----------|---------|----------|---------|-----------|
| 5207227017285 | 147-70632 | RGBW    | 120-240W | 1/100   | 42.30     |
| 5207227017308 | 147-70633 | RGB CCT | 120-240W | 1/100   | 43.85     |

DIMMERS / CONTROLLERS FOR LED TAPES •  
DIMMERS / CONTROLLERS ΓΙΑ ΤΑΙΝΙΕΣ LED



147-70601      147-70603      147-70604

**WIRELESS CONTROLLER**  
**ΑΣΥΡΜΑΤΟ CONTROLLER**

PRODUCTION MATERIAL: **PP & FPC**  
ΥΛΙΚΟ ΚΑΤΑΣΚΕΥΗΣ: **PP & FPC**



**White Box**  
with Sticker  
PACKING

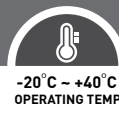

| BARCODE       | CODE      | TYPE   | WATT     | VOLTAGE | AMPERAGE                | WEIGHT  | PACKING | PRICE (€) |
|---------------|-----------|--------|----------|---------|-------------------------|---------|---------|-----------|
| 5206139706010 | 147-70601 | IR RGB | 72-144W  | 5-24V   | 6A                      | 0.075kg | 1/100   | 5.25      |
| 5206139004734 | 147-70603 | RF RGB | -        | -       | -                       | 0.070kg | 1/200   | 26.00     |
| 5206139051080 | 147-70604 | RF RGB | 216-432W | 12-24V  | 6A/channel<br>total 18A | 0.060kg | 1/100   | 24.00     |



147-70607

**WIRELESS CONTROLLER**  
**ΑΣΥΡΜΑΤΟ CONTROLLER**

PRODUCTION MATERIAL: **PP & FPC**  
ΥΛΙΚΟ ΚΑΤΑΣΚΕΥΗΣ: **PP & FPC**



**White Box**  
with Sticker  
PACKING

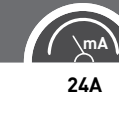

| BARCODE       | CODE      | TYPE    | WATT     | PACKING | PRICE (€) |
|---------------|-----------|---------|----------|---------|-----------|
| 5206139073358 | 147-70607 | RF RGBW | 288-576W | 1/100   | 37.50     |



147-70610      147-70612      147-70613

**WIRELESS CONTROLLER DIMMER**  
**ΑΣΥΡΜΑΤΟ CONTROLLER DIMMER**

PRODUCTION MATERIAL: **PP & FPC**  
ΥΛΙΚΟ ΚΑΤΑΣΚΕΥΗΣ: **PP & FPC**



**White Box**  
with Sticker  
PACKING



| BARCODE       | CODE      | TYPE      | WATT     | VOLTAGE | AMPERAGE | WEIGHT  | PACKING | PRICE (€) |
|---------------|-----------|-----------|----------|---------|----------|---------|---------|-----------|
| 5206139706102 | 147-70610 | ONE COLOR | 96-192W  | 12-24V  | 8A       | 0.100kg | 1/78    | 14.35     |
| 5206139051097 | 147-70612 | RF / 4 CH | -        | -       | -        | 0.070kg | 1/200   | 16.85     |
| 5206139051165 | 147-70613 | RF        | 122-288W | 12-24V  | 12A      | 0.060kg | 1/100   | 24.80     |

SIGNAL AMPLIFIERS & CONTROLLERS FOR LED TAPES • ΕΝΙΣΧΥΤΕΣ ΣΗΜΑΤΟΣ & CONTROLLERS ΓΙΑ ΤΑΙΝΙΕΣ LED

**SIGNAL AMPLIFIER  
ΕΝΙΣΧΥΤΗΣ ΣΗΜΑΤΟΣ**

PRODUCTION MATERIAL: **PP & FPC**  
ΥΛΙΚΟ ΚΑΤΑΣΚΕΥΗΣ: **PP & FPC**



147-70650

147-70651

147-70652



| BARCODE       | CODE             | TYPE | WATT     | AMPERAGE | WEIGHT  | PACKING | PRICE (€)    |
|---------------|------------------|------|----------|----------|---------|---------|--------------|
| 5206139706508 | <b>147-70650</b> | RGB  | 144-288W | 12A      | 0.140Kg | 1/100   | <b>13.85</b> |
| 5206139051202 | <b>147-70651</b> | RGB  | 288-576W | 24A      | 0.150Kg | 1/80    | <b>29.60</b> |
| 5206139073372 | <b>147-70652</b> | RGBW | 288-576W | 24A      | 0.100Kg | 1/100   | <b>26.45</b> |



**CONTROLLER**

PRODUCTION MATERIAL: **PP & FPC**  
ΥΛΙΚΟ ΚΑΤΑΣΚΕΥΗΣ: **PP & FPC**

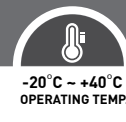
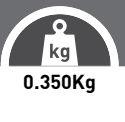
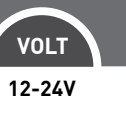

| BARCODE       | CODE             | TYPE     | WATT     | AMPERAGE | PACKING | PRICE (€)    |
|---------------|------------------|----------|----------|----------|---------|--------------|
| 5207227000072 | <b>147-70680</b> | DMX-3 CH | 144-288W | 12A      | 1/50    | <b>49.35</b> |
| 5207227007897 | <b>147-70681</b> | DMX-4 CH | 192-384W | 16A      | 1/50    | <b>54.60</b> |



**Μεταλλικά Τροφοδοτικά για ταινίες LED**

για Οικιακή & Επαγγελματική Χρήση

**Metallic Drivers for LED Tapes**

for Domestic & Professional use

Ίδανικοί για χρήση σε χώρους όπως:

- Κατοικίες
- Καταστήματα
- Εμπορικά Κέντρα
- Αποθήκες
- Βιοτεχνικούς Χώρους
- Βιομηχανικούς Χώρους
- Μοτέλ
- Ξενοδοχεία
- Αίθουσες Διδασκαλίας
- Εκθεσιακούς Χώρους
- Μουσεία
- Αρχιτεκτονικές Δομές
- Δημόσιες Εγκαταστάσεις

Ideal for use in places as:

- Residences
- Stores
- Shopping Malls
- Warehouses
- Business Areas
- Industrial Areas
- Motels
- Hotels
- Teaching Rooms
- Exhibitions
- Museums
- Architectural Structures
- Public Facilities

DRIVERS METALLIC • ΤΡΟΦΟΔΟΤΙΚΑ ΜΕΤΑΛΛΙΚΑ



**DRIVER METALLIC MINI**  
**ΤΡΟΦΟΔΟΤΙΚΟ ΜΕΤΑΛΛΙΚΟ MINI**

PRODUCTION MATERIAL: **ALUMINIUM**  
ΥΛΙΚΟ ΚΑΤΑΣΚΕΥΗΣ: **ΑΛΟΥΜΙΝΙΟ**



| IP20          | VOLT<br>200-240V<br>50-60Hz | OUTPUT VOLTAGE<br>12V | 6000h<br>LIFE TIME | -20°C ~ +40°C<br>OPERATING TEMP. | White Box with Sticker PACKING |         |           |
|---------------|-----------------------------|-----------------------|--------------------|----------------------------------|--------------------------------|---------|-----------|
| BARCODE       | CODE                        | WATT                  | AMPERAGE           | DIMENSIONS                       | WEIGHT                         | PACKING | PRICE (€) |
| 5207227013560 | 147-70560                   | 18W                   | 1.5A               | 18x18x172mm                      | 0.070kg                        | 1/200   | 8.35      |
| 5207227013584 | 147-70561                   | 24W                   | 2A                 | 18x18x172mm                      | 0.070kg                        | 1/200   | 9.45      |
| 5207227013607 | 147-70562                   | 36W                   | 3A                 | 18x18x192mm                      | 0.085kg                        | 1/200   | 12.95     |
| 5207227013621 | 147-70563                   | 48W                   | 4A                 | 18x18x312mm                      | 0.100kg                        | 1/200   | 16.45     |
| 5207227013645 | 147-70564                   | 60W                   | 5A                 | 18x18x312mm                      | 0.100kg                        | 1/200   | 18.80     |
| 5207227060939 | 147-70565                   | 75W                   | 6A                 | 18x18x355mm                      | 0.130kg                        | 1/200   | 25.60     |



**DRIVER METALLIC SLIM**  
**ΤΡΟΦΟΔΟΤΙΚΟ ΜΕΤΑΛΛΙΚΟ SLIM**

PRODUCTION MATERIAL: **ALUMINIUM**  
ΥΛΙΚΟ ΚΑΤΑΣΚΕΥΗΣ: **ΑΛΟΥΜΙΝΙΟ**



| IP20          | VOLT<br>200-240V<br>50-60Hz | OUTPUT VOLTAGE<br>12V | 6000h<br>LIFE TIME | -20°C ~ +40°C<br>OPERATING TEMP. | GROUNDING | White Box with Sticker PACKING |           |
|---------------|-----------------------------|-----------------------|--------------------|----------------------------------|-----------|--------------------------------|-----------|
| BARCODE       | CODE                        | WATT                  | AMPERAGE           | DIMENSIONS                       | WEIGHT    | PACKING                        | PRICE (€) |
| 5207227060977 | 147-70580                   | 60W                   | 5A                 | 33x40x160mm                      | 0.180kg   | 1/50                           | 17.15     |
| 5207227060991 | 147-70581                   | 100W                  | 8.3A               | 36x46x188mm                      | 0.240kg   | 1/50                           | 23.75     |
| 5207227061011 | 147-70582                   | 120W                  | 10A                | 36x46x188mm                      | 0.260kg   | 1/50                           | 25.30     |
| 5207227061035 | 147-70583                   | 150W                  | 12.5A              | 38x58x200mm                      | 0.380kg   | 1/60                           | 26.35     |
| 5207227061059 | 147-70584                   | 200W                  | 16.7A              | 40x71x224mm                      | 0.520kg   | 1/40                           | 36.85     |
| 5207227061073 | 147-70585                   | 250W                  | 20.9A              | 40x71x224mm                      | 0.520kg   | 1/40                           | 42.15     |
| 5207227061097 | 147-70586                   | 350W                  | 29A                | 43x68x223mm                      | 0.520kg   | 1/40                           | 45.85     |
| 5207227063671 | 147-70587                   | 400W                  | 33.3A              | 43x68x223mm                      | 0.580kg   | 1/40                           | 54.45     |
| 5207227069833 | 147-70588                   | 500W                  | 41.67A             | 43x68x223mm                      | 0.670kg   | 1/40                           | K.E.      |

DRIVERS METALLIC • ΤΡΟΦΟΔΟΤΙΚΑ ΜΕΤΑΛΛΙΚΑ



**DRIVER METALLIC**  
**ΤΡΟΦΟΔΟΤΙΚΟ ΜΕΤΑΛΛΙΚΟ**

PRODUCTION MATERIAL: **ALUMINIUM**  
ΥΛΙΚΟ ΚΑΤΑΣΚΕΥΗΣ: **ΑΛΟΥΜΙΝΙΟ**



| IP20          | VOLT<br>200-240V<br>50-60Hz | OUTPUT VOLTAGE<br>12V | 6000h<br>LIFE TIME | -20°C ~ +40°C<br>OPERATING TEMP. | GROUNDING | White Box with Sticker PACKING |           |
|---------------|-----------------------------|-----------------------|--------------------|----------------------------------|-----------|--------------------------------|-----------|
| BARCODE       | CODE                        | WATT                  | AMPERAGE           | DIMENSIONS                       | WEIGHT    | PACKING                        | PRICE (€) |
| 5206139705013 | 147-70501                   | 10W                   | 0.83A              | 30x40x70mm                       | 0.070kg   | 1/180                          | 7.15      |
| 5206139705020 | 147-70502                   | 15W                   | 1.25A              | 30x40x70mm                       | 0.070kg   | 1/180                          | 7.55      |
| 5206139705037 | 147-70503                   | 25W                   | 2.08A              | 21x48x78mm                       | 0.080kg   | 1/160                          | 10.45     |
| 5206139705044 | 147-70504                   | 40W                   | 3.33A              | 33x58x85mm                       | 0.120kg   | 1/80                           | 11.85     |
| 5206139705105 | 147-70510                   | 50W                   | 4.16A              | 36x78x110mm                      | 0.220kg   | 1/60                           | 15.15     |
| 5206139084743 | 147-70505                   | 60W                   | 5A                 | 36x78x110mm                      | 0.220kg   | 1/60                           | 15.45     |
| 5206139705112 | 147-70511                   | 100W                  | 8.3A               | 40x98x130mm                      | 0.330kg   | 1/60                           | 21.35     |
| 5207227013508 | 147-70516                   | 120W                  | 10A                | 40x98x130mm                      | 0.330kg   | 1/60                           | 23.35     |
| 5206139705129 | 147-70512                   | 150W                  | 12.5A              | 50x98x160mm                      | 0.430kg   | 1/40                           | 29.60     |
| 5206139705136 | 147-70513                   | 200W                  | 16.7A              | 50x98x160mm                      | 0.450kg   | 1/40                           | 34.35     |
| 5206139005014 | 147-70515                   | 250W                  | 20.83A             | 50x98x160mm                      | 0.490kg   | 1/50                           | 37.85     |
| 5206139705143 | 147-70514                   | 350W                  | 29.1A              | 50x100x200mm                     | 0.610kg   | 1/40                           | 47.85     |
| 5207227013522 | 147-70517                   | 400W                  | 33.3A              | 50x100x200mm                     | 0.610kg   | 1/40                           | 67.85     |
| 5207227013546 | 147-70518                   | 500W                  | 41.6A              | 65x125x240mm                     | 0.990kg   | 1/20                           | 79.60     |



**DRIVER METALLIC**  
**ΤΡΟΦΟΔΟΤΙΚΟ ΜΕΤΑΛΛΙΚΟ**

PRODUCTION MATERIAL: **ALUMINIUM**  
ΥΛΙΚΟ ΚΑΤΑΣΚΕΥΗΣ: **ΑΛΟΥΜΙΝΙΟ**



| IP67          | VOLT<br>200-240V<br>50-60Hz | OUTPUT VOLTAGE<br>12V | 6000h<br>LIFE TIME | -20°C ~ +40°C<br>OPERATING TEMP. | White Box with Sticker PACKING |         |           |
|---------------|-----------------------------|-----------------------|--------------------|----------------------------------|--------------------------------|---------|-----------|
| BARCODE       | CODE                        | WATT                  | AMPERAGE           | DIMENSIONS                       | WEIGHT                         | PACKING | PRICE (€) |
| 5206139015884 | 147-70520                   | 30W                   | 2.5A               | 20x30x230mm                      | 0.290kg                        | 1/50    | 18.45     |
| 5206139015891 | 147-70521                   | 45W                   | 3.75A              | 25x35x210mm                      | 0.310kg                        | 1/50    | 26.85     |
| 5206139705228 | 147-70522                   | 60W                   | 5A                 | 32x52x170mm                      | 0.510kg                        | 1/20    | 29.90     |
| 5206139705235 | 147-70523                   | 100W                  | 8.3A               | 40x70x178mm                      | 0.730kg                        | 1/20    | 46.80     |
| 5206139015907 | 147-70524                   | 150W                  | 12.5A              | 40x70x178mm                      | 0.970kg                        | 1/20    | 58.20     |
| 5206139015914 | 147-70525                   | 200W                  | 16.7A              | 43x65x260mm                      | 1.310kg                        | 1/15    | 76.80     |

DRIVERS METALLIC • ΤΡΟΦΟΔΟΤΙΚΑ ΜΕΤΑΛΛΙΚΑ



**DRIVER METALLIC MINI**  
**ΤΡΟΦΟΔΟΤΙΚΟ ΜΕΤΑΛΛΙΚΟ MINI**  
 PRODUCTION MATERIAL: **ALUMINIUM**  
 ΥΛΙΚΟ ΚΑΤΑΣΚΕΥΗΣ: **ΑΛΟΥΜΙΝΙΟ**



| IP20          | VOLT<br>200-240V<br>50-60Hz | OUTPUT<br>VOLTAGE<br>24V | 6000h<br>LIFE TIME | -20°C - +40°C<br>OPERATING TEMP. | White Box<br>with Sticker<br>PACKING |         |           |
|---------------|-----------------------------|--------------------------|--------------------|----------------------------------|--------------------------------------|---------|-----------|
| BARCODE       | CODE                        | WATT                     | AMPERAGE           | DIMENSIONS                       | WEIGHT                               | PACKING | PRICE (€) |
| 5207227013751 | 147-70570                   | 18W                      | 0.75A              | 18x18x172mm                      | 0.070kg                              | 1/200   | 8.35      |
| 5207227013775 | 147-70571                   | 24W                      | 1A                 | 18x18x172mm                      | 0.070kg                              | 1/200   | 9.45      |
| 5207227013799 | 147-70572                   | 36W                      | 1.5A               | 18x18x282mm                      | 0.085kg                              | 1/200   | 12.95     |
| 5207227013812 | 147-70573                   | 48W                      | 2A                 | 18x18x312mm                      | 0.100kg                              | 1/200   | 16.45     |
| 5207227013836 | 147-70574                   | 60W                      | 2.5A               | 18x18x312mm                      | 0.100kg                              | 1/200   | 18.80     |
| 5207227060953 | 147-70575                   | 75W                      | 3A                 | 18x18x312mm                      | 0.145kg                              | 1/200   | 25.60     |



**DRIVER METALLIC SLIM**  
**ΤΡΟΦΟΔΟΤΙΚΟ ΜΕΤΑΛΛΙΚΟ SLIM**  
 PRODUCTION MATERIAL: **ALUMINIUM**  
 ΥΛΙΚΟ ΚΑΤΑΣΚΕΥΗΣ: **ΑΛΟΥΜΙΝΙΟ**



| IP20          | VOLT<br>200-240V<br>50-60Hz | OUTPUT<br>VOLTAGE<br>24V | 6000h<br>LIFE TIME | -20°C - +40°C<br>OPERATING TEMP. | GROUNDING | White Box<br>with Sticker<br>PACKING |           |
|---------------|-----------------------------|--------------------------|--------------------|----------------------------------|-----------|--------------------------------------|-----------|
| BARCODE       | CODE                        | WATT                     | AMPERAGE           | DIMENSIONS                       | WEIGHT    | PACKING                              | PRICE (€) |
| 5207227061158 | 147-70590                   | 60W                      | 2.5A               | 33x40x160mm                      | 0.180kg   | 1/50                                 | 17.15     |
| 5207227061196 | 147-70591                   | 100W                     | 4.1A               | 36x46x188mm                      | 0.240kg   | 1/50                                 | 23.75     |
| 5207227061219 | 147-70592                   | 120W                     | 5A                 | 36x46x188mm                      | 0.260kg   | 1/50                                 | 25.30     |
| 5207227061233 | 147-70593                   | 150W                     | 6.25A              | 38x58x200mm                      | 0.380kg   | 1/60                                 | 26.35     |
| 5207227061257 | 147-70594                   | 200W                     | 8.3A               | 40x71x224mm                      | 0.520kg   | 1/40                                 | 36.85     |
| 5207227061271 | 147-70595                   | 250W                     | 10.5A              | 40x71x224mm                      | 0.520kg   | 1/40                                 | 42.15     |
| 5207227061295 | 147-70596                   | 350W                     | 14.5A              | 43x68x223mm                      | 0.520kg   | 1/40                                 | 45.85     |
| 5207227061318 | 147-70597                   | 400W                     | 16.7A              | 43x68x223mm                      | 0.580kg   | 1/40                                 | 54.45     |
| 5207227069840 | 147-70598                   | 500W                     | 20.84A             | 43x68x223mm                      | 0.670kg   | 1/40                                 | K.E.      |

DRIVERS METALLIC • ΤΡΟΦΟΔΟΤΙΚΑ ΜΕΤΑΛΛΙΚΑ



**DRIVER METALLIC**  
**ΤΡΟΦΟΔΟΤΙΚΟ ΜΕΤΑΛΛΙΚΟ**  
 PRODUCTION MATERIAL: **ALUMINIUM**  
 ΥΛΙΚΟ ΚΑΤΑΣΚΕΥΗΣ: **ΑΛΟΥΜΙΝΙΟ**



| IP20          | VOLT<br>200-240V<br>50-60Hz | OUTPUT<br>VOLTAGE<br>24V | 6000h<br>LIFE TIME | -20°C - +40°C<br>OPERATING TEMP. | GROUNDING | White Box<br>with Sticker<br>PACKING |           |
|---------------|-----------------------------|--------------------------|--------------------|----------------------------------|-----------|--------------------------------------|-----------|
| BARCODE       | CODE                        | WATT                     | AMPERAGE           | DIMENSIONS                       | WEIGHT    | PACKING                              | PRICE (€) |
| 5206139015938 | 147-70531                   | 15W                      | 0.625A             | 21x48x78mm                       | 0.080kg   | 1/60                                 | 7.55      |
| 5207227013676 | 147-70532                   | 25W                      | 1A                 | 21x48x78mm                       | 0.080kg   | 1/160                                | 10.45     |
| 5206139015921 | 147-70530                   | 40W                      | 1.67A              | 33x58x85mm                       | 0.120kg   | 1/80                                 | 11.85     |
| 5206139015945 | 147-70535                   | 50W                      | 2.08A              | 36x78x110mm                      | 0.220kg   | 1/60                                 | 15.15     |
| 5207227013690 | 147-70533                   | 60W                      | 2.5A               | 36x78x110mm                      | 0.220kg   | 1/60                                 | 15.45     |
| 5206139015952 | 147-70536                   | 100W                     | 4.16A              | 40x98x130mm                      | 0.430kg   | 1/40                                 | 21.35     |
| 5207227013713 | 147-70534                   | 120W                     | 5A                 | 40x98x130mm                      | 0.330kg   | 1/60                                 | 23.35     |
| 5206139015969 | 147-70537                   | 150W                     | 6.25A              | 50x98x160mm                      | 0.430kg   | 1/40                                 | 29.60     |
| 5206139015976 | 147-70538                   | 200W                     | 8.3A               | 50x98x160mm                      | 0.450kg   | 1/40                                 | 34.35     |
| 5206139015983 | 147-70539                   | 350W                     | 14.6A              | 50x100x200mm                     | 0.610kg   | 1/40                                 | 47.85     |



**DRIVER METALLIC**  
**ΤΡΟΦΟΔΟΤΙΚΟ ΜΕΤΑΛΛΙΚΟ**  
 PRODUCTION MATERIAL: **ALUMINIUM**  
 ΥΛΙΚΟ ΚΑΤΑΣΚΕΥΗΣ: **ΑΛΟΥΜΙΝΙΟ**







| IP67          | VOLT<br>200-240V<br>50-60Hz | OUTPUT<br>VOLTAGE<br>24V | 6000h<br>LIFE TIME | -20°C - +40°C<br>OPERATING TEMP. | White Box<br>with Sticker<br>PACKING |         |           |
|---------------|-----------------------------|--------------------------|--------------------|----------------------------------|--------------------------------------|---------|-----------|
| BARCODE       | CODE                        | WATT                     | AMPERAGE           | DIMENSIONS                       | WEIGHT                               | PACKING | PRICE (€) |
| 5207227013737 | 147-70540                   | 30W                      | 1.25A              | 20x30x230mm                      | 0.290kg                              | 1/50    | 18.45     |
| 5207227008399 | 147-70541                   | 45W                      | 1.87A              | 25x35x210mm                      | 0.310kg                              | 1/50    | 26.85     |
| 5207227008412 | 147-70542                   | 60W                      | 2.5A               | 32x52x170mm                      | 0.510kg                              | 1/20    | 29.90     |
| 5207227005893 | 147-70543                   | 100W                     | 4.14A              | 40x70x178mm                      | 0.740kg                              | 1/20    | 46.80     |
| 5207227005886 | 147-70544                   | 150W                     | 6.25A              | 40x70x210mm                      | 0.970kg                              | 1/20    | 58.20     |
| 5207227008436 | 147-70545                   | 200W                     | 8.3A               | 43x65x260mm                      | 1.310kg                              | 1/15    | 76.80     |

ALUMINIUM PROFILE • ΠΡΟΦΙΛ ΑΛΟΥΜΙΝΙΟΥ

|   |                           |  |                                       |                           |
|---|---------------------------|--|---------------------------------------|---------------------------|
|    | <b>2000x13x3mm</b>        |       | <b>Brown Box with Sticker PACKING</b> |                           |
| 5206139092717   | 147-70760                 | ALUMINUM PROFILE SINGLE HEATSINK<br>ΠΡΟΦΙΛ ΑΛΟΥΜΙΝΙΟΥ ΜΟΝΟ ΨΥΚΤΡΑ  | 1/40                                  | PRICE (€)<br><b>4.55</b>  |
|    | <b>2000x17.33x14.5mm</b>  |      | <b>Brown Box with Sticker PACKING</b> |                           |
| 5206139056467   | 147-70761                 | ALUMINUM PROFILE RECESSED SINGLE 45°<br>ΠΡΟΦΙΛ ΑΛΟΥΜΙΝΙΟΥ ΧΩΝΕΥΤΟ ΜΟΝΟ 45°   | 1/50                                  | PRICE (€)<br><b>9.46</b>  |
|    | <b>2000x17.65x7mm</b>     |       | <b>Brown Box with Sticker PACKING</b> |                           |
| 5206139056443   | 147-70762                 | ALUMINUM PROFILE EXTERNAL SINGLE 90°<br>ΠΡΟΦΙΛ ΑΛΟΥΜΙΝΙΟΥ ΕΞΩΤΕΡΙΚΟ ΜΟΝΟ 90°   | 1/100                                 | PRICE (€)<br><b>9.68</b>  |
|   | <b>2000x26.48x18.11mm</b> |       | <b>Brown Box with Sticker PACKING</b> |                           |
| 5206139056528   | 147-70763                 | ALUMINUM PROFILE SINGLE CORNER 45°<br>ΠΡΟΦΙΛ ΑΛΟΥΜΙΝΙΟΥ ΜΟΝΟ ΓΩΝΙΑ 45°   | 1/100                                 | PRICE (€)<br><b>11.85</b> |
|  | <b>2000x16x16mm</b>       |       | <b>Brown Box with Sticker PACKING</b> |                           |
| 5206139056481   | 147-70764                 | ALUMINUM PROFILE SINGLE CORNER 90°<br>ΠΡΟΦΙΛ ΑΛΟΥΜΙΝΙΟΥ ΜΟΝΟ ΓΩΝΙΑ 90°   | 1/100                                 | PRICE (€)<br><b>9.15</b>  |
|  | <b>2000x29.7x29.7mm</b>   |       | <b>Brown Box with Sticker PACKING</b> |                           |
| 5206139056504   | 147-70765                 | ALUMINUM PROFILE DOUBLE 90°<br>ΠΡΟΦΙΛ ΑΛΟΥΜΙΝΙΟΥ ΔΙΠΛΟ 90°   | 1/50                                  | PRICE (€)<br><b>19.65</b> |
|  | <b>2000x17.33x14.5mm</b>  |       | <b>Brown Box with Sticker PACKING</b> |                           |
| 5206139056412   | 147-70766                 | ALUMINUM PROFILE EXTERNAL SINGLE 45°<br>ΠΡΟΦΙΛ ΑΛΟΥΜΙΝΙΟΥ ΕΞΩΤΕΡΙΚΟ ΜΟΝΟ 45°   | 1/100                                 | PRICE (€)<br><b>12.90</b> |

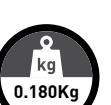
ALUMINIUM PROFILE • ΠΡΟΦΙΛ ΑΛΟΥΜΙΝΙΟΥ

|   |                         |   |                                       |                           |
|---|-------------------------|---|---------------------------------------|---------------------------|
|    | <b>2000x24.6x7mm</b>    |       | <b>Brown Box with Sticker PACKING</b> |                           |
| 5206139063373   | 147-70767               | ALUMINUM PROFILE RECESSED SINGLE 90°<br>ΠΡΟΦΙΛ ΑΛΟΥΜΙΝΙΟΥ ΧΩΝΕΥΤΟ ΜΟΝΟ 90°  | 1/100                                 | PRICE (€)<br><b>10.60</b> |
|    | <b>2000x21.3x26.1mm</b> |      | <b>Brown Box with Sticker PACKING</b> |                           |
| 5206139056566   | 147-70768               | ALUMINUM PROFILE RECESSED FLOOR WATERPROOF SINGLE 45°<br>ΠΡΟΦΙΛ ΑΛΟΥΜΙΝΙΟΥ ΧΩΝΕΥΤΟ ΔΑΠΕΔΟΥ ΣΤΕΓΑΝΟ ΜΟΝΟ 45°   | 1/50                                  | PRICE (€)<br><b>56.85</b> |
|    | <b>2000x27.06x11mm</b>  |      | <b>Brown Box with Sticker PACKING</b> |                           |
| 5206139056542   | 147-70769               | ALUMINUM PROFILE RECESSED FLOOR WATERPROOF SINGLE 90°<br>ΠΡΟΦΙΛ ΑΛΟΥΜΙΝΙΟΥ ΧΩΝΕΥΤΟ ΔΑΠΕΔΟΥ ΣΤΕΓΑΝΟ ΜΟΝΟ 90°   | 1/50                                  | PRICE (€)<br><b>54.60</b> |
|   | <b>2000x90x32mm</b>     |      | <b>Brown Box with Sticker PACKING</b> |                           |
| 5206139056580   | 147-70770               | ALUMINUM PROFILE RECESSED FOR 4 LED TAPES<br>ΠΡΟΦΙΛ ΑΛΟΥΜΙΝΙΟΥ ΧΩΝΕΥΤΟ ΓΙΑ 4 LED ΤΑΙΝΙΕΣ  | 1/5                                   | PRICE (€)<br><b>98.60</b> |
|  | <b>2000x18x5.7mm</b>    |       | <b>Brown Box with Sticker PACKING</b> |                           |
| 5207227005596   | 147-70774               | FLEXIBLE ALUMINUM PROFILE<br>ΕΥΚΑΜΠΤΟ ΠΡΟΦΙΛ ΑΛΟΥΜΙΝΙΟΥ   | 1/250                                 | PRICE (€)<br><b>19.10</b> |
|  | <b>2000x10x8.4mm</b>    |       | <b>Brown Box with Sticker PACKING</b> |                           |
| 5207227005602   | 147-70775               | MINI ALUMINUM PROFILE<br>MINI ΠΡΟΦΙΛ ΑΛΟΥΜΙΝΙΟΥ   | 1/250                                 | PRICE (€)<br><b>17.20</b> |
|  | <b>2000x30x3.5mm</b>    |       | <b>Brown Box with Sticker PACKING</b> |                           |
| 5207227004216   | 147-70776               | ALUMINUM PROFILE DOUBLE HEATSINK<br>ΠΡΟΦΙΛ ΑΛΟΥΜΙΝΙΟΥ ΔΙΠΛΗ ΨΥΚΤΡΑ  | 1/30                                  | PRICE (€)<br><b>9.25</b>  |
|  | <b>2000x15x10mm</b>     |      | <b>Brown Box with Sticker PACKING</b> |                           |
| 5207227069215   | 147-70778               | MINI LED ALUMINUM PROFILE FOR ROPE LIGHT<br>ΠΡΟΦΙΛ ΑΛΟΥΜΙΝΙΟΥ ΓΙΑ ΜΟΝΗ ΣΩΛΗΝΑ ROPE LIGHT  | 1/100                                 | PRICE (€)<br><b>8.45</b>  |

PLUGS & CONNECTORS FOR LED TAPES • ΦΙΣ & CONNECTORS ΓΙΑ ΤΑΙΝΙΕΣ LED

|  |  |  |  |  |  |  |  |               |           |   |       |           |      |
|--|--|--|--|--|--|--|--|---------------|-----------|---|-------|-----------|------|
|  |  |  |  |  |  |  |  | 5206139707000 | 147-70700 | PLUG FOR LED TAPE<br>ΦΙΣ ΤΑΙΝΙΑΣ LED                                | 1/100 | PRICE (€) | 0.55 |
|  |  |  |  |  |  |  |  | 5206139707024 | 147-70702 | PLUG FOR LED TAPE<br>ΦΙΣ LED CONNECTOR                              | 1/100 | PRICE (€) | 0.40 |
|  |  |  |  |  |  |  |  | 5206139054302 | 147-70711 | PLUG LED CONNECTOR<br>ΦΙΣ LED CONNECTOR                             | 1/100 | PRICE (€) | 0.96 |
|  |  |  |  |  |  |  |  | 5206139054340 | 147-70714 | CORNER 2 CONNECTIONS<br>ΓΩΝΙΑ 2 ΕΠΑΦΩΝ                              | 1/100 | PRICE (€) | 1.48 |
|  |  |  |  |  |  |  |  | 5206139054401 | 147-70717 | T TYPE 2 CONNECTIONS<br>ΤΑΘ 2 ΕΠΑΦΩΝ                                | 1/100 | PRICE (€) | 2.06 |
|  |  |  |  |  |  |  |  | 5206139054241 | 147-70750 | CROSS TYPE 2 CONNECTIONS<br>ΣΤΑΥΡΟΣ 2 ΕΠΑΦΩΝ                        | 1/100 | PRICE (€) | 2.61 |
|  |  |  |  |  |  |  |  | 5206139054272 | 147-70753 | PLUG LED CONNECTOR 2 CHANNELS<br>ΦΙΣ LED CONNECTOR 2 ΕΠΑΦΩΝ         | 1/100 | PRICE (€) | 0.67 |
|  |  |  |  |  |  |  |  | 5206139054289 | 147-70754 | PLUG FOR LED TAPE WITH 2 CONNECTIONS<br>ΦΙΣ ΤΑΙΝΙΑΣ LED ΜΕ 2 ΕΠΑΦΕΣ | 1/100 | PRICE (€) | 0.82 |

PLUGS & CONNECTORS FOR LED TAPES • ΦΙΣ & CONNECTORS ΓΙΑ ΤΑΙΝΙΕΣ LED

|  |  |  |  |  |  |  |  |               |           |  |       |           |      |
|--|--|--|--|--|--|--|--|---------------|-----------|--|-------|-----------|------|
|  |  |  |  |  |  |  |  | 5206139054296 | 147-70755 | PLUG LED CONNECTOR<br>ΦΙΣ LED CONNECTOR                            | 1/100 | PRICE (€) | 1.38 |
|  |  |  |  |  |  |  |  | 5206139707048 | 147-70704 | PLUG FOR LED TAPE<br>ΦΙΣ ΤΑΙΝΙΑΣ LED                               | 1/100 | PRICE (€) | 0.58 |
|  |  |  |  |  |  |  |  | 5206139707055 | 147-70705 | PLUG LED CONNECTOR<br>ΦΙΣ LED CONNECTOR                            | 1/100 | PRICE (€) | 0.44 |
|  |  |  |  |  |  |  |  | 5206139054364 | 147-70715 | CORNER TYPE 2 CONNECTIONS<br>ΓΩΝΙΑ 2 ΕΠΑΦΩΝ                        | 1/100 | PRICE (€) | 1.56 |
|  |  |  |  |  |  |  |  | 5206139054418 | 147-70718 | T TYPE 2 CONNECTIONS<br>ΤΑΘ 2 ΕΠΑΦΩΝ                               | 1/100 | PRICE (€) | 2.18 |
|  |  |  |  |  |  |  |  | 5206139054258 | 147-70751 | CROSS TYPE 2 CONNECTIONS<br>ΣΤΑΥΡΟΣ 2 ΕΠΑΦΩΝ                       | 1/100 | PRICE (€) | 2.61 |
|  |  |  |  |  |  |  |  | 5206139707017 | 147-70701 | PLUG FOR LED TAPE<br>ΦΙΣ ΤΑΙΝΙΑΣ LED                               | 1/100 | PRICE (€) | 0.79 |
|  |  |  |  |  |  |  |  | 5206139707031 | 147-70703 | PLUG LED CONNECTOR 4 CONNECTIONS<br>ΦΙΣ LED CONNECTOR 4 ΕΠΑΦΩΝ RGB | 1/100 | PRICE (€) | 0.48 |

PLUGS & CONNECTORS FOR LED TAPES • ΦΙΣ & CONNECTORS ΓΙΑ ΤΑΙΝΙΕΣ LED

|  |  |  |  |  |  |  |  |               |           |  |        |           |      |
|--|--|--|--|--|--|--|--|---------------|-----------|--|--------|-----------|------|
|  |  |  |  |  |  |  |  | 5206139054326 | 147-70713 | PLUG LED CONNECTOR 4 CONNECTIONS RGB<br>ΦΙΣ LED CONNECTOR 4 ΕΠΑΦΩΝ RGB | 1/100  | PRICE (€) | 1.18 |
|  |  |  |  |  |  |  |  | 5206139054371 | 147-70716 | CORNER TYPE 4 CONNECTIONS RGB<br>ΓΩΝΙΑ 4 ΕΠΑΦΩΝ RGB                    | 1/100  | PRICE (€) | 1.56 |
|  |  |  |  |  |  |  |  | 5206139054425 | 147-70719 | T TYPE 4 CONNECTIONS RGB<br>ΤΑΦ 4 ΕΠΑΦΩΝ RGB                           | 1/100  | PRICE (€) | 2.28 |
|  |  |  |  |  |  |  |  | 5206139054265 | 147-70752 | CROSS TYPE 4 CONNECTIONS RGB<br>ΣΤΑΥΡΟΣ 4 ΕΠΑΦΩΝ RGB                   | 1/100  | PRICE (€) | 2.61 |
|  |  |  |  |  |  |  |  | 5206139045058 | 147-70706 | PLUG FOR LED TAPE WITH 2 CHANNELS<br>ΦΙΣ ΤΑΙΝΙΑΣ LED ΜΕ 2 ΚΑΝΑΛΙΑ      | 1/250  | PRICE (€) | 4.85 |
|  |  |  |  |  |  |  |  | 5206139035493 | 147-70707 | CONNECTOR 2 CONNECTIONS FOR LED TAPE<br>ΦΙΣ LED CONNECTOR 2 ΕΠΑΦΩΝ     | 1/1000 | PRICE (€) | 0.98 |
|  |  |  |  |  |  |  |  | 5206139036124 | 147-70709 | END CAP FOR TAPE LIGHT<br>ΤΑΠΑ ΓΙΑ ΤΑΙΝΙΑ LED                          | 1/1000 | PRICE (€) | 0.21 |
|  |  |  |  |  |  |  |  | 5206139036179 | 147-70710 | MOUNTING CLIP<br>ΒΑΣΗ ΩΜΕΓΑ ΓΙΑ ΤΑΙΝΙΑ LED                             | 1/1000 | PRICE (€) | 0.21 |



## Γραμμικός Φωτισμός Εσωτερικού Χώρου

για Επαγγελματική Χρήση

Ιδανικοί για χρήση σε χώρους όπως:

- Κατοικίες
- Καταστήματα
- Εμπορικά Κέντρα
- Αποθήκες
- Βιοτεχνικούς Χώρους
- Βιομηχανικούς Χώρους
- Μοτέλ
- Ξενοδοχεία
- Αίθουσες Διδασκαλίας
- Εκθεσιακούς Χώρους
- Μουσεία
- Αρχιτεκτονικές Δομές
- Δημόσιες Εγκαταστάσεις

## LED Linear Lighting Indoor Use

for Professional use

Ideal for use in places as:

- Residences
- Stores
- Shopping Malls
- Warehouses
- Business Areas
- Industrial Areas
- Motels
- Hotels
- Teaching Rooms
- Exhibitions
- Museums
- Architectural Structures
- Public Facilities

## SPECIAL ORDERS



**IN DIMENSIONS  
& COLORS**  
ΣΕ ΔΙΑΣΤΑΣΕΙΣ  
& ΧΡΩΜΑΤΑ



**NEW!**

PRO  
PRODUCTION MATERIAL: ALUMINIUM & PLASTIC  
ΥΛΙΚΟ ΚΑΤΑΣΚΕΥΗΣ: ΑΛΟΥΜΙΝΙΟ & ΠΛΑΣΤΙΚΟ

IP44 ENERGY CLASS A+ NOT DIMMABLE VOLT 170-265V 50-60Hz LUMENS 105/W INSTALLATION HEIGHT 2,5-4,5M SMD 5050 CLASS I 2 YEARS WARRANTY

TICKER FREE BEAM ANGLE 120° PF >0.9 Ra >80 15000 ON-OFF 30000h LIFE TIME START TIME min: 0.5 sec -10°C - +60°C OPERATING TEMP. BROWN BOX PACKING

| CODE      | WATT | KELVIN | DIMENSIONS   | COLOR          | PACKING | PRICE (€) |
|-----------|------|--------|--------------|----------------|---------|-----------|
| 840-70100 | 18W  | 4000K  | 600x50x75mm  | VARIOUS COLORS | 1/1     | 180.00    |
| 840-70101 | 23W  | 4000K  | 800x50x75mm  | VARIOUS COLORS | 1/1     | 212.00    |
| 840-70102 | 30W  | 4000K  | 1000x50x75mm | VARIOUS COLORS | 1/1     | 221.00    |
| 840-70103 | 35W  | 4000K  | 1200x50x75mm | VARIOUS COLORS | 1/1     | 282.00    |
| 840-70104 | 44W  | 4000K  | 1500x50x75mm | VARIOUS COLORS | 1/1     | 346.00    |
| 840-70105 | 58W  | 4000K  | 2000x50x75mm | VARIOUS COLORS | 1/1     | 382.00    |
| 840-70106 | 24W  | 4000K  | 600x50x75mm  | VARIOUS COLORS | 1/1     | 196.00    |
| 840-70107 | 32W  | 4000K  | 800x50x75mm  | VARIOUS COLORS | 1/1     | 242.00    |
| 840-70108 | 40W  | 4000K  | 1000x50x75mm | VARIOUS COLORS | 1/1     | 256.00    |
| 840-70109 | 48W  | 4000K  | 1200x50x75mm | VARIOUS COLORS | 1/1     | 308.00    |
| 840-70110 | 60W  | 4000K  | 1500x50x75mm | VARIOUS COLORS | 1/1     | 378.00    |
| 840-70111 | 80W  | 4000K  | 2000x50x75mm | VARIOUS COLORS | 1/1     | 442.00    |



## NICKEL MAT

**NEW!**

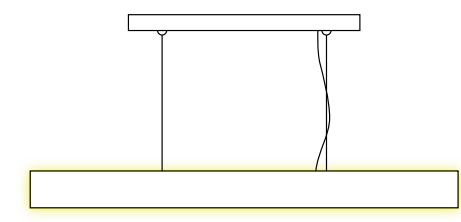







PRO  
PRODUCTION MATERIAL: ALUMINIUM & PLASTIC  
ΥΛΙΚΟ ΚΑΤΑΣΚΕΥΗΣ: ΑΛΟΥΜΙΝΙΟ & ΠΛΑΣΤΙΚΟ

IP44 ENERGY CLASS A+ NOT DIMMABLE VOLT 170-265V 50-60Hz LUMENS 105/W INSTALLATION HEIGHT 2,5-4,5M SMD 5050 CLASS I 2 YEARS WARRANTY

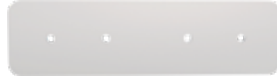
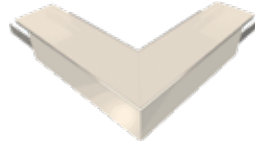
TICKER FREE BEAM ANGLE 120° PF >0.9 Ra >80 15000 ON-OFF 30000h LIFE TIME START TIME min: 0.5 sec -10°C - +60°C OPERATING TEMP. BROWN BOX PACKING

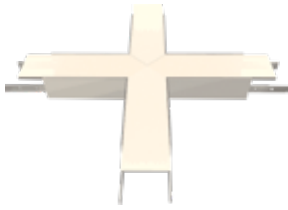
| CODE      | WATT | KELVIN | DIMENSIONS   | COLOR      | PACKING | PRICE (€) |
|-----------|------|--------|--------------|------------|---------|-----------|
| 840-70120 | 18W  | 4000K  | 600x50x75mm  | NICKEL MAT | 1/1     | 148.00    |
| 840-70121 | 23W  | 4000K  | 800x50x75mm  | NICKEL MAT | 1/1     | 182.00    |
| 840-70122 | 30W  | 4000K  | 1000x50x75mm | NICKEL MAT | 1/1     | 191.00    |
| 840-70123 | 35W  | 4000K  | 1200x50x75mm | NICKEL MAT | 1/1     | 226.00    |
| 840-70124 | 44W  | 4000K  | 1500x50x75mm | NICKEL MAT | 1/1     | 298.00    |
| 840-70125 | 58W  | 4000K  | 2000x50x75mm | NICKEL MAT | 1/1     | 338.00    |
| 840-70126 | 24W  | 4000K  | 600x50x75mm  | NICKEL MAT | 1/1     | 166.00    |
| 840-70127 | 32W  | 4000K  | 800x50x75mm  | NICKEL MAT | 1/1     | 208.00    |
| 840-70128 | 40W  | 4000K  | 1000x50x75mm | NICKEL MAT | 1/1     | 223.00    |
| 840-70129 | 48W  | 4000K  | 1200x50x75mm | NICKEL MAT | 1/1     | 272.00    |
| 840-70130 | 60W  | 4000K  | 1500x50x75mm | NICKEL MAT | 1/1     | 328.00    |
| 840-70131 | 80W  | 4000K  | 2000x50x75mm | NICKEL MAT | 1/1     | 388.00    |

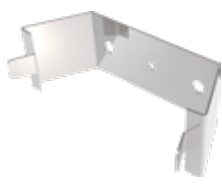
LINEAR LIGHT FIXTURES ACCESSORIES • ΑΞΕΣΟΥΑΡ ΓΡΑΜΜΙΚΩΝ ΦΩΤΙΣΤΙΚΩΝ

|   |                |               |           |   |        |                             |                                |                    |
|---|----------------|---------------|-----------|---|--------|-----------------------------|--------------------------------|--------------------|
|    | 15x2x100mm     | 5207227017346 | 147-70781 | ALUMINUM LINK STRAIGHT A5075<br>ΣΥΝΔΕΣΜΟΣ ΑΛΟΥΜΙΝΙΟΥ ΕΥΘΕΙΑΣ A5075                                | 1/3000 | 2 YEARS WARRANTY<br>0,020Kg | Brown Box with Sticker PACKING | PRICE (€)<br>4.30  |
|    | 150x75x150mm   | 5207227017360 | 147-70782 | ANGLE ALUMINUM A5075<br>ΓΩΝΙΑ ΑΛΟΥΜΙΝΙΟΥ A5075  | 1/30   | 2 YEARS WARRANTY<br>0,210Kg | Brown Box with Sticker PACKING | PRICE (€)<br>43.60 |
|    | 250x125x75mm   | 5207227017384 | 147-70783 | T" SHAPE ALUMINUM A5075<br>ΤΑΦ ΑΛΟΥΜΙΝΙΟΥ A5075   | 1/20   | 2 YEARS WARRANTY<br>0,260Kg | Brown Box with Sticker PACKING | PRICE (€)<br>49.20 |
|   | 250x250x75mm   | 5207227017407 | 147-70784 | ALUMINUM CROSS A5075<br>ΣΤΑΥΡΟΣ ΑΛΟΥΜΙΝΙΟΥ A5075  | 1/20   | 2 YEARS WARRANTY<br>0,290Kg | Brown Box with Sticker PACKING | PRICE (€)<br>57.30 |
|  | 50x2x75mm      | 5207227017421 | 147-70785 | CAP ALUMINUM A5075<br>ΤΑΠΑ ΑΛΟΥΜΙΝΙΟΥ A5075   | 1/1000 | 2 YEARS WARRANTY<br>0,002Kg | Brown Box with Sticker PACKING | PRICE (€)<br>5.60  |
|  | 20x10x30mm     | 5207227017445 | 147-70786 | EXTERNAL FITTING FOOT BASE ALUMINUM A5075<br>ΒΑΣΗ ΣΤΕΡΕΩΣΗΣ ΕΞΩΤΕΡΙΚΗΣ ΤΟΠΟΘΕΤΗΣ ΑΛΟΥΜΙΝΙΟΥ A5075 | 1/1000 | 2 YEARS WARRANTY<br>0,001Kg | Brown Box with Sticker PACKING | PRICE (€)<br>1.45  |
|  | 25x30x40mm     | 5207227017469 | 147-70787 | FOOT BASE FIXING SUSPENSION ALUMINUM A5075<br>ΒΑΣΗ ΣΤΕΡΕΩΣΗΣ ΧΩΝΕΥΤΗΣ ΤΟΠΟΘΕΤΗΣ ΑΛΟΥΜΙΝΙΟΥ A5075  | 1/500  | 2 YEARS WARRANTY<br>0,010Kg | Brown Box with Sticker PACKING | PRICE (€)<br>1.45  |
|  | 1.5x1.5x2000mm | 5207227017483 | 147-70788 | SUSPENDING WIRE PENDANT INSTALLATION A5075<br>ΝΤΙΖΑ ΚΡΕΜΑΣΤΗΣ ΤΟΠΟΘΕΤΗΣ A5075                     | 1/400  | 2 YEARS WARRANTY<br>0,050Kg | Brown Box with Sticker PACKING | PRICE (€)<br>6.85  |



Επαγγελματικός Φωτισμός  
Εσωτερικού Χώρου

για Επαγγελματική Χρήση

Ιδανικοί για χρήση σε χώρους όπως:

- Κατοικίες
- Καταστήματα
- Εμπορικά Κέντρα
- Αποθήκες
- Βιοτεχνικούς Χώρους
- Βιομηχανικούς Χώρους
- Μοτέλ
- Ξενοδοχεία
- Αίθουσες Διδασκαλίας
- Εκθεσιακούς Χώρους
- Μουσεία
- Αρχιτεκτονικές Δομές
- Δημόσιες Εγκαταστάσεις

Professional Lighting  
Indoor Use

for Professional use

Ideal for use in places as:

- Residences
- Stores
- Shopping Malls
- Warehouses
- Business Areas
- Industrial Areas
- Motels
- Hotels
- Teaching Rooms
- Exhibitions
- Museums
- Architectural Structures
- Public Facilities

SPOT RECESSED FIXED • ΣΠΟΤ ΧΩΝΕΥΤΑ ΣΤΑΘΕΡΑ

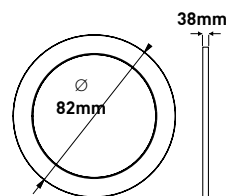

PRODUCTION MATERIAL: **ALUMINIUM**  
ΥΛΙΚΟ ΚΑΤΑΣΚΕΥΗΣ: **ΑΛΟΥΜΙΝΙΟ**

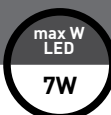

| BARCODE       | CODE      | VOLT     | TYPE | COLOR | PACKING | PRICE (€) |
|---------------|-----------|----------|------|-------|---------|-----------|
| 5207227019159 | 147-52100 | 220-240V | GU10 | WHITE | 1/100   | 7.15      |
| 5207227019173 | 147-52101 | 220-240V | GU10 | SATIN | 1/100   | 7.90      |

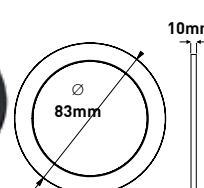
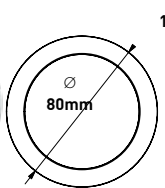

PRODUCTION MATERIAL: **METALLIC**  
ΥΛΙΚΟ ΚΑΤΑΣΚΕΥΗΣ: **ΜΕΤΑΛΛΙΚΟ**

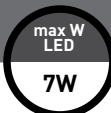

| BARCODE       | CODE      | VOLT     | TYPE | COLOR          | PACKING | PRICE (€) |
|---------------|-----------|----------|------|----------------|---------|-----------|
| 5207227030864 | 147-52510 | 220-240V | GU10 | WHITE          | 1/100   | 2.95      |
| 5207227030888 | 147-52513 | 220-240V | GU10 | NICKEL SATIN   | 1/100   | 3.95      |
| 5207227060090 | 147-55610 | 12V      | G5,3 | WHITE          | 5/100   | 2.70      |
| 5207227060113 | 147-55611 | 12V      | G5,3 | GOLD           | 5/100   | 3.55      |
| 5207227060137 | 147-55612 | 12V      | G5,3 | NICKEL         | 5/100   | 3.55      |
| 5207227060144 | 147-55613 | 12V      | G5,3 | NICKEL SATIN   | 5/100   | 3.55      |
| 5207227060175 | 147-55614 | 12V      | G5,3 | GOLD SATIN     | 5/100   | 3.55      |
| 5207227060199 | 147-55615 | 12V      | G5,3 | ANTIQUE BRONZE | 5/100   | 3.55      |
| 5207227060212 | 147-55616 | 12V      | G5,3 | ANTIQUE COPPER | 5/100   | 3.55      |
| 5207227060250 | 147-55617 | 12V      | G5,3 | BLACK          | 5/100   | 2.70      |

SPOT RECESSED MOVABLE • ΣΠΟΤ ΧΩΝΕΥΤΑ ΚΙΝΗΤΑ



| BARCODE       | CODE      | VOLT     | TYPE | COLOR          | PACKING | PRICE (€) |
|---------------|-----------|----------|------|----------------|---------|-----------|
| 5207227030901 | 147-52520 | 220-240V | GU10 | WHITE          | 1/100   | 4.65      |
| 5207227030925 | 147-52523 | 220-240V | GU10 | NICKEL SATIN   | 1/100   | 4.95      |
| 5207227060267 | 147-55620 | 12V      | G5,3 | BLACK          | 5/100   | 4.25      |
| 5207227060281 | 147-55621 | 12V      | G5,3 | WHITE          | 5/100   | 4.25      |
| 5207227060304 | 147-55622 | 12V      | G5,3 | GOLD           | 5/100   | 4.75      |
| 5207227060328 | 147-55623 | 12V      | G5,3 | NICKEL         | 5/100   | 4.75      |
| 5207227060342 | 147-55624 | 12V      | G5,3 | NICKEL SATIN   | 5/100   | 4.75      |
| 5207227060366 | 147-55625 | 12V      | G5,3 | GOLD SATIN     | 5/100   | 4.75      |
| 5207227060373 | 147-55626 | 12V      | G5,3 | ANTIQUE BRONZE | 5/100   | 4.75      |
| 5207227060397 | 147-55627 | 12V      | G5,3 | ANTIQUE COPPER | 5/100   | 4.75      |

SPOT RECESSED FIXED • ΣΠΟΤ ΧΩΝΕΥΤΑ ΣΤΑΘΕΡΑ

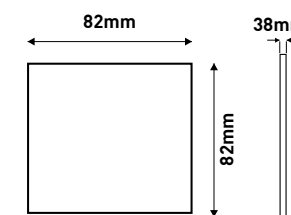

PRODUCTION MATERIAL: **ALUMINIUM**  
ΥΛΙΚΟ ΚΑΤΑΣΚΕΥΗΣ: **ΑΛΟΥΜΙΝΙΟ**

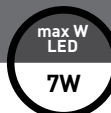

| BARCODE       | CODE      | VOLT     | TYPE | COLOR | PACKING | PRICE (€) |
|---------------|-----------|----------|------|-------|---------|-----------|
| 5206139305107 | 147-52110 | 220-240V | GU10 | WHITE | 1/100   | 7.15      |
| 5206139305114 | 147-52111 | 220-240V | GU10 | SATIN | 1/100   | 7.90      |

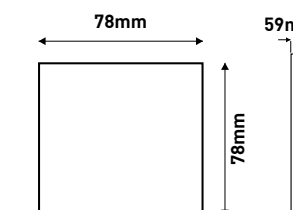

PRODUCTION MATERIAL: **METALLIC**  
ΥΛΙΚΟ ΚΑΤΑΣΚΕΥΗΣ: **ΜΕΤΑΛΛΙΚΟ**



| BARCODE       | CODE      | VOLT | TYPE | COLOR        | PACKING | PRICE (€) |
|---------------|-----------|------|------|--------------|---------|-----------|
| 5207227060403 | 147-52630 | 12V  | G5,3 | WHITE        | 5/100   | 3.75      |
| 5207227060410 | 147-52631 | 12V  | G5,3 | BLACK        | 5/100   | 3.75      |
| 5207227060427 | 147-52632 | 12V  | G5,3 | NICKEL SATIN | 5/100   | 3.95      |

SPOT RECESSED MOVABLE • ΣΠΟΤ ΧΩΝΕΥΤΑ ΚΙΝΗΤΑ

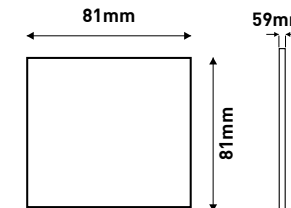

PRODUCTION MATERIAL: **METALLIC**  
ΥΛΙΚΟ ΚΑΤΑΣΚΕΥΗΣ: **ΜΕΤΑΛΛΙΚΟ**

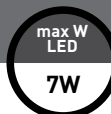

| BARCODE       | CODE      | VOLT | TYPE | COLOR        | PACKING | PRICE (€) |
|---------------|-----------|------|------|--------------|---------|-----------|
| 5207227060434 | 147-52640 | 12V  | G5,3 | WHITE        | 1/100   | 5.10      |
| 5207227060441 | 147-52641 | 12V  | G5,3 | BLACK        | 1/100   | 5.10      |
| 5207227060458 | 147-52642 | 12V  | G5,3 | NICKEL SATIN | 1/100   | 5.35      |

SPOT PLASTER • ΣΠΟΤ ΓΥΨΙΝΑ

**NEW!**

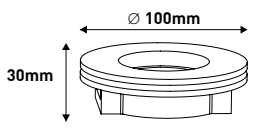



TYPE GU10 max W LED 6W max W HALOGEN 28W IP20 -20°C ~ +70°C OPERATING TEMP. cutting hole ø103mm kg 0,280Kg

5207227067709 147-53201 SPOT PLASTER SINGLE ROUND ΣΠΟΤ ΓΥΨΙΝΟ ΜΟΝΟ ΣΤΡΟΓΓΥΛΟ 1/30

White Box with Sticker PACKING PRICE (€) 7.65

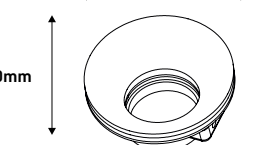
**NEW!**





TYPE GU10 max W LED 6W max W HALOGEN 28W IP20 -20°C ~ +70°C OPERATING TEMP. cutting hole ø103mm kg 0,190Kg

5207227067785 147-53205 SPOT PLASTER SINGLE ROUND ΣΠΟΤ ΓΥΨΙΝΟ ΜΟΝΟ ΣΤΡΟΓΓΥΛΟ 1/36

White Box with Sticker PACKING PRICE (€) 10.65

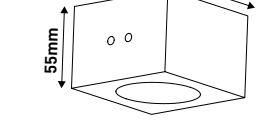
**NEW!**





TYPE GU10 max W LED 6W max W HALOGEN 28W IP20 -20°C ~ +70°C OPERATING TEMP. cutting hole 83x83mm kg 0,400Kg

5207227067761 147-53204 SPOT PLASTER SINGLE SQUARE ΣΠΟΤ ΓΥΨΙΝΟ ΜΟΝΟ ΤΕΤΡΑΓΩΝΟ 1/36

White Box with Sticker PACKING PRICE (€) 8.75

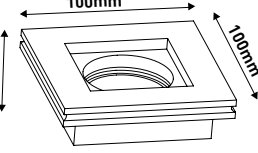
**NEW!**





TYPE GU10 max W LED 6W max W HALOGEN 28W IP20 -20°C ~ +70°C OPERATING TEMP. cutting dimension 103x103mm kg 0,300Kg

5207227067686 147-53200 SPOT PLASTER SINGLE SQUARE ΣΠΟΤ ΓΥΨΙΝΟ ΜΟΝΟ ΤΕΤΡΑΓΩΝΟ 1/30

White Box with Sticker PACKING PRICE (€) 7.65

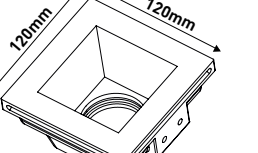
**NEW!**

TYPE GU10 max W LED 6W max W HALOGEN 28W IP20 -20°C ~ +70°C OPERATING TEMP. cutting hole 123x123mm kg 0,620Kg

5207227067723 147-53202 SPOT PLASTER SINGLE SQUARE ΣΠΟΤ ΓΥΨΙΝΟ ΜΟΝΟ ΤΕΤΡΑΓΩΝΟ 1/24

White Box with Sticker PACKING PRICE (€) 9.85

SPOT PLASTER • ΣΠΟΤ ΓΥΨΙΝΑ

**NEW!**

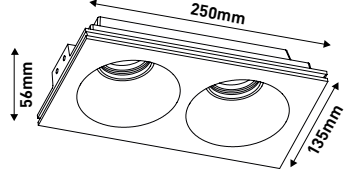



TYPE GU10 max W LED 6W max W HALOGEN 28W IP20 -20°C ~ +70°C OPERATING TEMP. cutting hole 253x138mm kg 1,590Kg

5207227067808 147-53206 SPOT PLASTER DOUBLE SQUARE INDIRECT LIGHTING ΣΠΟΤ ΓΥΨΙΝΟ ΔΙΠΛΟ ΤΕΤΡΑΓΩΝΟ ΕΜΜΕΣΟΥ ΦΩΤΙΣΜΟΥ 1/9

White Box with Sticker PACKING PRICE (€) 28.95

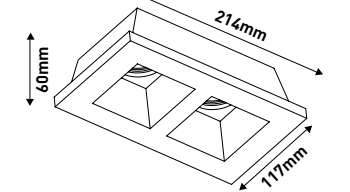
**NEW!**





TYPE GU10 max W LED 6W max W HALOGEN 28W IP20 -20°C ~ +70°C OPERATING TEMP. cutting hole 217x120mm kg 1,340Kg

5207227067747 147-53203 SPOT PLASTER DOUBLE SQUARE ΣΠΟΤ ΓΥΨΙΝΟ ΔΙΠΛΟ ΤΕΤΡΑΓΩΝΟ 1/12

White Box with Sticker PACKING PRICE (€) 19.85

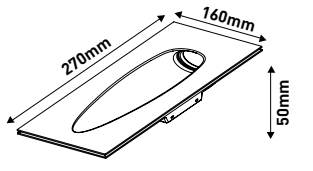
**NEW!**

TYPE LED CREE IP20 NOT DIMMABLE ENERGY CLASS A WATT 1W VOLT 220-240V 50-60Hz mA 350mA KELVIN 3000K LUMENS 80

PF >0.5 Ra >80 30000h LIFE TIME 15000 ON-OFF START TIME min: 0.5 sec XP-E 300x163mm -20°C ~ +70°C OPERATING TEMP. 1,560g

5207227067846 147-53208 SPOT PLASTER PARALLELOGRAM ΣΠΟΤ ΓΥΨΙΝΟ ΠΑΡΑΛΛΗΛΟΓΡΑΜΜΟ 1/6

White Box with Sticker PACKING PRICE (€) 39.85

**NEW!**

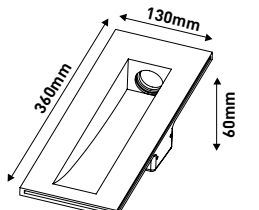
TYPE LED CREE IP20 NOT DIMMABLE ENERGY CLASS A WATT 1W VOLT 220-240V 50-60Hz mA 350mA KELVIN 3000K LUMENS 80



PF >0.5 Ra >80 30000h LIFE TIME 15000 ON-OFF START TIME min: 0.5 sec XP-E 363x133mm -20°C ~ +70°C OPERATING TEMP. 1,520g

5207227067822 147-53207 SPOT PLASTER PARALLELOGRAM ΣΠΟΤ ΓΥΨΙΝΟ ΠΑΡΑΛΛΗΛΟΓΡΑΜΜΟ 1/6

White Box with Sticker PACKING PRICE (€) 38.65

PLASTER WALL LIGHTS • ΑΠΛΙΚΕΣ ΓΥΨΙΝΕΣ

**NEW!**

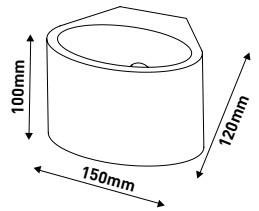
**TYPE G9** **max W LED 6W** **max W HALOGEN 28W** **IP20** **-20°C ~ +70°C OPERATING TEMP.** **1,230Kg**

**White Box with Sticker PACKING**

5207227067860 147-53300 WALL LIGHT PLASTER OVAL MEDIUM  
ΑΠΛΙΚΑ ΤΟΙΧΟΥ ΟΒΑΛ ΜΕΔΙΟΥ ΓΥΨΙΝΗ 1/8

**PRICE (€)**  
36.45

**NEW!**



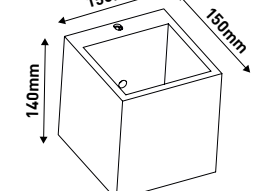

**TYPE G9** **max W LED 6W** **max W HALOGEN 28W** **IP20** **-20°C ~ +70°C OPERATING TEMP.** **1,510Kg**

**White Box with Sticker PACKING**

5207227067884 147-53301 WALL LIGHT PLASTER CUBE  
ΑΠΛΙΚΑ ΤΟΙΧΟΥ ΚΥΒΟΣ ΓΥΨΙΝΗ 1/8

**PRICE (€)**  
43.65

**NEW!**

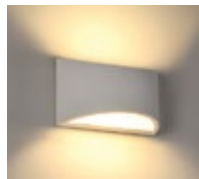
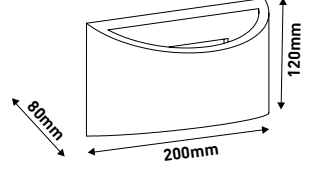

**TYPE G9** **max W LED 6W** **max W HALOGEN 28W** **IP20** **-20°C ~ +70°C OPERATING TEMP.** **0,670Kg**

**White Box with Sticker PACKING**

5207227067907 147-53302 WALL LIGHT PLASTER OVAL MEDIUM  
ΑΠΛΙΚΑ ΤΟΙΧΟΥ ΟΒΑΛ ΜΕΔΙΟΥ ΓΥΨΙΝΗ 1/6

**PRICE (€)**  
34.20

**NEW!**

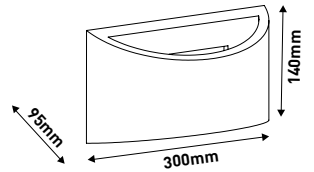
**TYPE G9** **max W LED 2x6W** **max W HALOGEN 2x28W** **IP20** **-20°C ~ +70°C OPERATING TEMP.** **1,330Kg**

**White Box with Sticker PACKING**

5207227067921 147-53303 WALL LIGHT PLASTER OVAL LARGE  
ΑΠΛΙΚΑ ΤΟΙΧΟΥ ΟΒΑΛ LARGE ΓΥΨΙΝΗ 1/6

**PRICE (€)**  
49.65

PLASTER WALL LIGHTS • ΑΠΛΙΚΕΣ ΓΥΨΙΝΕΣ

**NEW!**

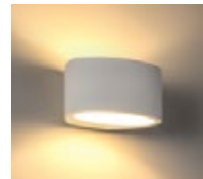
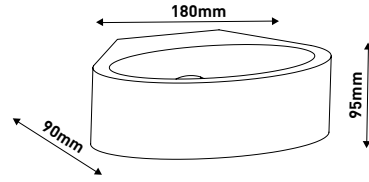
**TYPE G9** **max W LED 6W** **max W HALOGEN 28W** **IP20** **-20°C ~ +70°C OPERATING TEMP.** **0,700Kg**

**White Box with Sticker PACKING**

5207227067945 147-53304 WALL LIGHT PLASTER OVAL SMALL  
ΑΠΛΙΚΑ ΤΟΙΧΟΥ ΟΒΑΛ SMALL ΓΥΨΙΝΗ 1/8

**PRICE (€)**  
33.85

**NEW!**





**TYPE E14** **max W LED 6W** **max W HALOGEN 28W** **IP20** **-20°C ~ +70°C OPERATING TEMP.** **1,340Kg**

**White Box with Sticker PACKING**

5207227067983 147-53306 WALL LIGHT PLASTER ROUND  $\phi$ 165mm  
ΑΠΛΙΚΑ ΤΟΙΧΟΥ ΣΤΡΟΓΓΥΛΗ ΓΥΨΙΝΗ  $\phi$ 165mm 1/8

**PRICE (€)**  
46.65

**NEW!**





**TYPE E14** **max W LED 6W** **max W HALOGEN 28W** **IP20** **-20°C ~ +70°C OPERATING TEMP.** **1,390Kg**

**White Box with Sticker PACKING**

5207227068003 147-53307 WALL LIGHT PLASTER OVAL  
ΑΠΛΙΚΑ ΤΟΙΧΟΥ ΟΒΑΛ ΓΥΨΙΝΗ 1/4

**PRICE (€)**  
36.85

**NEW!**





**TYPE E14** **max W LED 6W** **max W HALOGEN 28W** **IP20** **-20°C ~ +70°C OPERATING TEMP.** **0,980Kg**

**White Box with Sticker PACKING**

5207227068027 147-53308 WALL LIGHT PLASTER OVAL  
ΑΠΛΙΚΑ ΤΟΙΧΟΥ ΟΒΑΛ ΓΥΨΙΝΗ 1/6

**PRICE (€)**  
44.65

PLASTER WALL LIGHTS • ΑΠΛΙΚΕΣ ΓΥΨΙΝΕΣ

**NEW!**

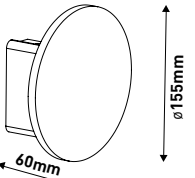
TYPE LED CREE, NOT DIMMABLE, ENERGY CLASS A, IP20, 2x3W, 220-240V 50-60Hz, 300mA, 3000K, 85 LUMENS

PF >0.5, Ra >80, 30000h LIFE TIME, 15000 ON-OFF, START TIME min. 0.5 sec, XP-E, cutting hole ø158mm, -20°C - +70°C OPERATING TEMP., 0,650kg

5207227067969 147-53305 WALL LIGHT PLASTER ROUND ΑΠΛΙΚΑ ΤΟΙΧΟΥ ΣΤΡΟΓΓΥΛΗ ΓΥΨΙΝΗ 1/6 PRICE (€) 76.65

PRO 2 YEARS WARRANTY

White Box with Sticker PACKING

**NEW!**

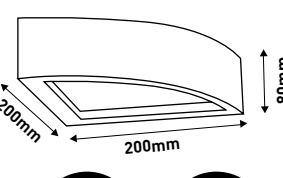
TYPE E14, max W LED 6W, max W HALOGEN 28W, IP20, -20°C - +70°C OPERATING TEMP., 1,410Kg

5207227068140 147-53314 WALL LIGHT PLASTER OVAL 90° ΑΠΛΙΚΑ ΤΟΙΧΟΥ ΟΒΑΛ 90° 1/4 PRICE (€) 47.85

3 YEARS WARRANTY

White Box with Sticker PACKING

**NEW!**

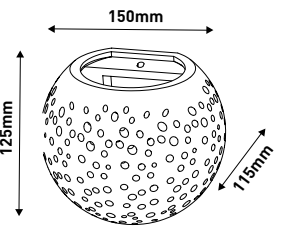
TYPE G9, max W LED 6W, max W HALOGEN 28W, IP20, -20°C - +70°C OPERATING TEMP., 0,900Kg

5207227068041 147-53309 WALL LIGHT PLASTER OVAL PERFORATED ΑΠΛΙΚΑ ΤΟΙΧΟΥ ΟΒΑΛ ΔΙΑΤΡΗΤΗ ΓΥΨΙΝΗ 1/8 PRICE (€) 29.25

3 YEARS WARRANTY

White Box with Sticker PACKING

**NEW!**

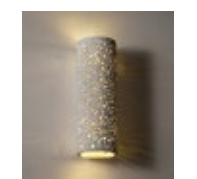
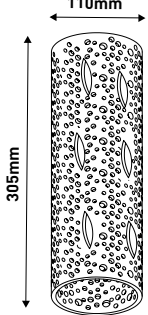
TYPE E14, max W LED 2x6W, max W HALOGEN 2x28W, IP20, -20°C - +70°C OPERATING TEMP., 1,150Kg

5207227068102 147-53312 WALL LIGHT PLASTER UP-DOWN PERFORATED ΑΠΛΙΚΑ ΤΟΙΧΟΥ UP-DOWN ΔΙΑΤΡΗΤΗ ΣΤΡΟΓΓΥΛΗ 1/4 PRICE (€) 52.65

3 YEARS WARRANTY

White Box with Sticker PACKING

PLASTER WALL LIGHTS • ΑΠΛΙΚΕΣ ΓΥΨΙΝΕΣ

**NEW!**

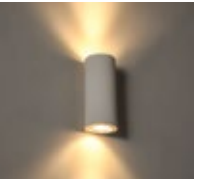
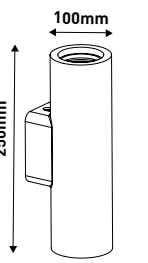
TYPE GU10, max W LED 2x6W, max W HALOGEN 2x28W, IP20, -20°C - +70°C OPERATING TEMP., 1,690Kg

5207227068065 147-53310 WALL LIGHT PLASTER UP-DOWN ROUND ΑΠΛΙΚΑ ΤΟΙΧΟΥ UP-DOWN ΣΤΡΟΓΓΥΛΗ ΓΥΨΙΝΗ 1/6 PRICE (€) 36.40

3 YEARS WARRANTY

White Box with Sticker PACKING

**NEW!**

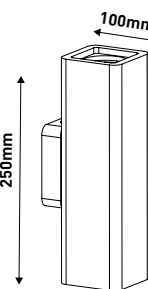
TYPE GU10, max W LED 2x6W, max W HALOGEN 2x28W, IP20, -20°C - +70°C OPERATING TEMP., 1,720Kg

5207227068089 147-53311 WALL LIGHT PLASTER UP-DOWN SQUARE ΑΠΛΙΚΑ ΤΟΙΧΟΥ UP-DOWN ΤΕΤΡΑΓΩΝΗ 1/6 PRICE (€) 34.60

3 YEARS WARRANTY

White Box with Sticker PACKING

**NEW!**

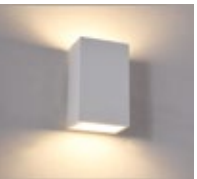
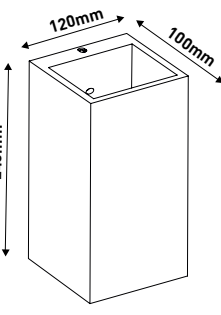
TYPE GU10, max W LED 2x6W, max W HALOGEN 2x28W, IP20, -20°C - +70°C OPERATING TEMP., 1,710 Kg

5207227068126 147-53313 WALL LIGHT PLASTER UP-DOWN ΑΠΛΙΚΑ ΤΟΙΧΟΥ UP-DOWN ΓΥΨΙΝΗ 1/4 PRICE (€) 35.85

3 YEARS WARRANTY

White Box with Sticker PACKING

CEILING SPEAKER • ΗΧΕΙΟ ΟΡΟΦΗΣ

PRODUCTION MATERIAL: ABS  
ΥΛΙΚΟ ΚΑΤΑΣΚΕΥΗΣ: ABS

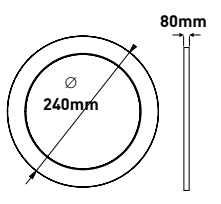
WATT 10W, VOLT 100V 90-18kHz, DECIBEL 91db, cutting hole ø205mm, IP20, -10°C - +60°C OPERATING TEMP., 1,110Kg

5207227032189 147-68973 CEILING SPEAKER WHITE ΗΧΕΙΟ ΟΡΟΦΗΣ ΛΕΥΚΟ 1/20 PRICE (€) 41.60

2 YEARS WARRANTY

Color Box PACKING

TRACK LIGHT LED • ΣΠΟΤ ΡΑΓΑΣ LED

PRODUCTION MATERIAL: **ALUMINIUM & PLASTIC**  
ΥΛΙΚΟ ΚΑΤΑΣΚΕΥΗΣ: **ΑΛΟΥΜΙΝΙΟ & ΠΛΑΣΤΙΚΟ**



ø55x240mm

| BARCODE       | CODE      | WATT | KELVIN | LUMEN / WATT | COLOR | PACKING | PRICE (€) |
|---------------|-----------|------|--------|--------------|-------|---------|-----------|
| 5207227016004 | 145-55042 | 10W  | 4000K  | 90 lm/watt   | WHITE | 1/24    | 32.90     |
| 5207227016028 | 145-55043 | 10W  | 4000K  | 90 lm/watt   | BLACK | 1/24    | 32.90     |



NEW!  
ø75x160mm  
ø84x160mm

PRODUCTION MATERIAL: **ALUMINIUM & PLASTIC**  
ΥΛΙΚΟ ΚΑΤΑΣΚΕΥΗΣ: **ΑΛΟΥΜΙΝΙΟ & ΠΛΑΣΤΙΚΟ**

| BARCODE       | CODE       | WATT | KELVIN | LUMEN / WATT | COLOR | PACKING | PRICE (€) |  |
|---------------|------------|------|--------|--------------|-------|---------|-----------|--|
| 5206139009227 | 145-55000  | 20W  | 4000K  | 85 lm/watt   | WHITE | 1/24    | 45.60     |  |
| 5207227061554 | 145-55001  | 20W  | 4000K  | 85 lm/watt   | BLACK | 1/24    | 45.60     |  |
| 5207227061585 | 145-55002* | 30W  | 4000K  | 85 lm/watt   | WHITE | 1/20    | 52.35     |  |
| 5207227061608 | 145-55003* | 30W  | 4000K  | 85 lm/watt   | BLACK | 1/20    | 52.35     |  |



ø100x196x156.5mm

PRODUCTION MATERIAL: **ALUMINIUM & PLASTIC**  
ΥΛΙΚΟ ΚΑΤΑΣΚΕΥΗΣ: **ΑΛΟΥΜΙΝΙΟ & ΠΛΑΣΤΙΚΟ**

| BARCODE       | CODE      | WATT | KELVIN | LUMEN / WATT | COLOR | PACKING | PRICE (€) |
|---------------|-----------|------|--------|--------------|-------|---------|-----------|
| 5207227013850 | 145-55034 | 30W  | 4000K  | 90 lm/watt   | WHITE | 1/10    | 64.50     |
| 5207227013874 | 145-55035 | 30W  | 4000K  | 90 lm/watt   | BLACK | 1/10    | 64.50     |



TRACK LIGHT LED • ΣΠΟΤ ΡΑΓΑΣ LED

PRODUCTION MATERIAL: **ALUMINIUM & PLASTIC**  
ΥΛΙΚΟ ΚΑΤΑΣΚΕΥΗΣ: **ΑΛΟΥΜΙΝΙΟ & ΠΛΑΣΤΙΚΟ**



ø100x150x210mm

| BARCODE       | CODE      | WATT | KELVIN | LUMEN / WATT | COLOR | PACKING | PRICE (€) |
|---------------|-----------|------|--------|--------------|-------|---------|-----------|
| 5207227067365 | 145-55004 | 30W  | 4000K  | 85 lm/watt   | WHITE | 1/12    | 57.85     |
| 5207227067457 | 145-55005 | 30W  | 4000K  | 85 lm/watt   | BLACK | 1/12    | 57.85     |



PRODUCTION MATERIAL: **ALUMINIUM & PLASTIC**  
ΥΛΙΚΟ ΚΑΤΑΣΚΕΥΗΣ: **ΑΛΟΥΜΙΝΙΟ & ΠΛΑΣΤΙΚΟ**

ø90x260mm

| BARCODE       | CODE      | WATT | KELVIN | LUMEN / WATT | COLOR | PACKING | PRICE (€) |
|---------------|-----------|------|--------|--------------|-------|---------|-----------|
| 5207227016042 | 145-55044 | 30W  | 4000K  | 90 lm/watt   | WHITE | 1/15    | 112.00    |
| 5207227016066 | 145-55045 | 30W  | 4000K  | 90 lm/watt   | BLACK | 1/15    | 112.00    |



TRACK LIGHT LED ACCESSORIES • ΑΞΕΣΟΥΑΡ ΣΠΟΤ ΡΑΓΑΣ LED

PRODUCTION MATERIAL: **METALLIC**  
ΥΛΙΚΟ ΚΑΤΑΣΚΕΥΗΣ: **ΜΕΤΑΛΛΙΚΟ**



ø233x83x83mm

|               |           |   |      |       |
|---------------|-----------|---|------|-------|
| 5207227016080 | 145-55046 | BLIND FOR SPOT LIGHT 145-55044 / 55045 BLACK ΠΕΡΣΙΔΑ ΓΙΑ ΣΠΟΤ ΡΑΓΑΣ 145-55044 / 55045 ΜΑΥΡΟ | 1/30 | 21.80 |
|---------------|-----------|---|------|-------|

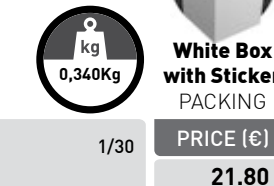

PRODUCTION MATERIAL: **ALUMINIUM & PLASTIC**  
ΥΛΙΚΟ ΚΑΤΑΣΚΕΥΗΣ: **ΑΛΟΥΜΙΝΙΟ & ΠΛΑΣΤΙΚΟ**  
UNIVERSAL



ø120x200x150mm

Connection Type: 4 wire adaptor

| BARCODE       | CODE      | LAMPHOLDER | COLOR | PACKING | PRICE (€) |  |
|---------------|-----------|------------|-------|---------|-----------|--|
| 5206139079398 | 145-55032 | E27        | BLACK | 1/24    | 28.60     |  |
| 5206139079381 | 145-55033 | E27        | WHITE | 1/24    | 28.60     |  |



TRACK LIGHT LED • ΣΠΟΤ ΡΑΓΑΣ LED



**NEW!**

PRODUCTION MATERIAL: **ALUMINIUM**  
ΥΛΙΚΟ ΚΑΤΑΣΚΕΥΗΣ: **ΑΛΟΥΜΙΝΙΟ**  
WITH ADJUSTABLE LIGHT ANGLE  
ΜΕ ΡΥΘΜΙΖΟΜΕΝΗ ΓΩΝΙΑ ΦΩΤΙΣΜΟΥ

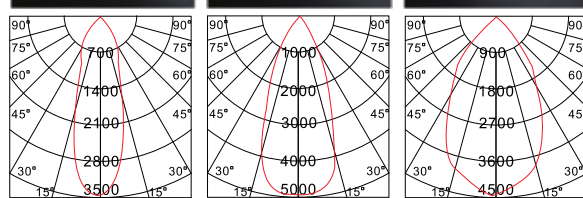
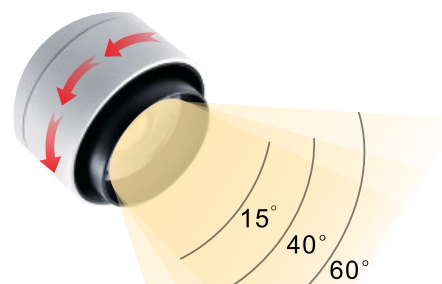
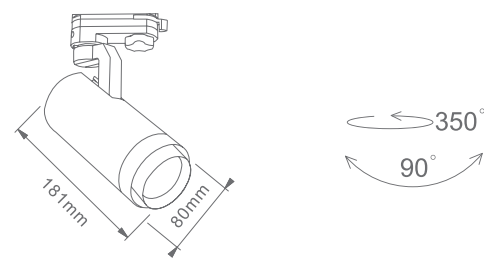

- IP20
- NOT DIMMABLE
- A+ ENERGY CLASS
- LINES 4
- VOLT 220-240V 50-60Hz
- 700mA
- INSTALLATION HEIGHT 5M
- COB
- 0.950Kg

- BEAM ANGLE 20°-60°
- PF >0.9
- Ra >80
- 10000 ON-OFF
- 30000h LIFE TIME
- START TIME min: 0.5 sec
- 20°C ~ +45°C OPERATING TEMP.

PRO  
2 YEARS WARRANTY

White Box with Sticker PACKING

| BARCODE       | CODE      | WATT | KELVIN          | LUMEN / WATT | COLOR | PACKING | PRICE (€) |
|---------------|-----------|------|-----------------|--------------|-------|---------|-----------|
| 5207227071997 | 145-55030 | 30W  | 3000-4000-6000K | 90 lm/watt   | WHITE | 1/8     | 117.00    |
| 5207227072000 | 145-55031 | 30W  | 3000-4000-6000K | 90 lm/watt   | BLACK | 1/8     | 117.00    |

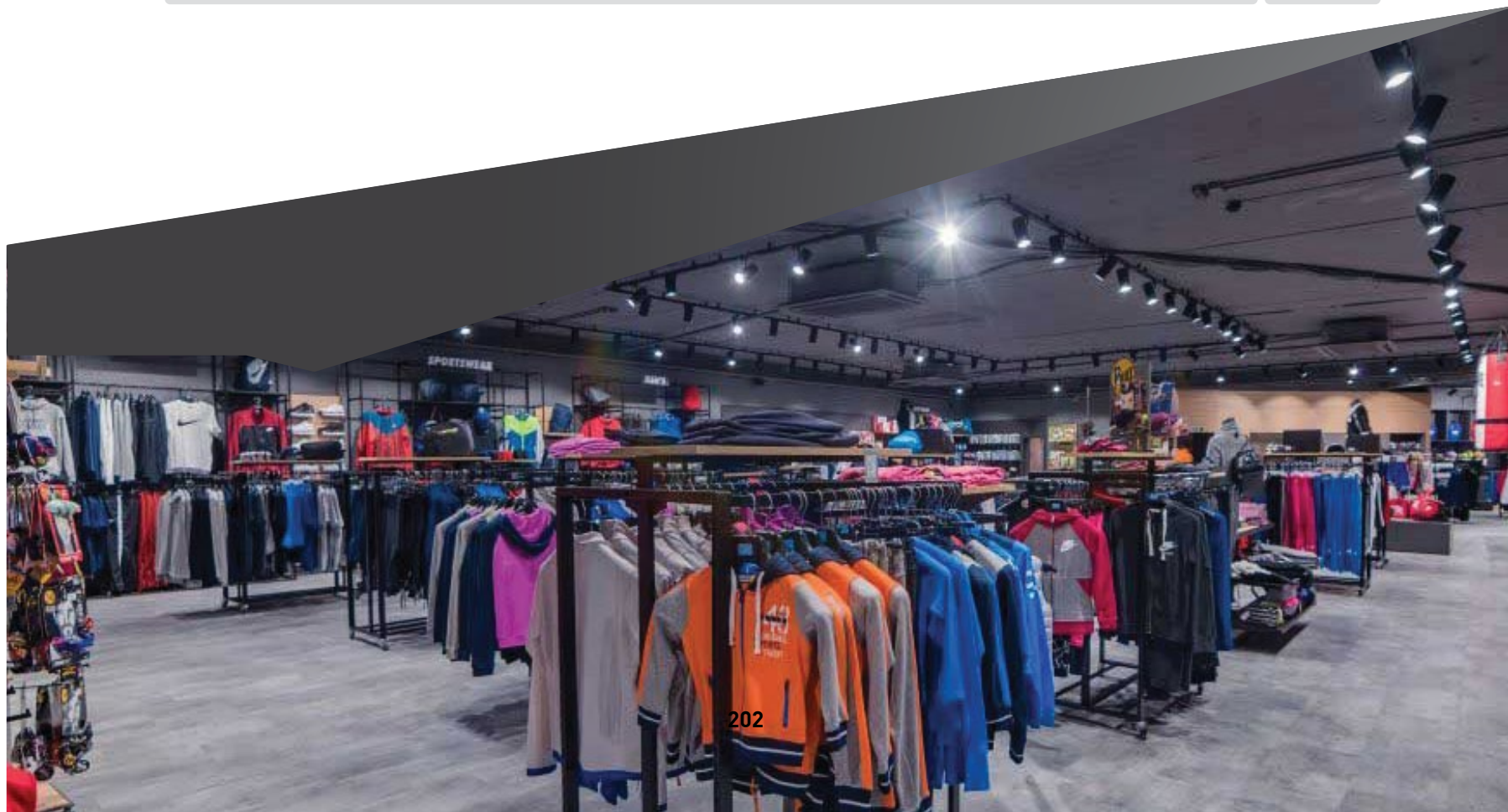

LINEAR TRACK LIGHT LED • ΣΠΟΤ ΡΑΓΑΣ LED ΓΡΑΜΜΙΚΟ



**NEW!**

PRODUCTION MATERIAL: **ALUMINIUM & PC**  
ΥΛΙΚΟ ΚΑΤΑΣΚΕΥΗΣ: **ΑΛΟΥΜΙΝΙΟ & PC**  
495x33x58mm

145-55090

145-55091

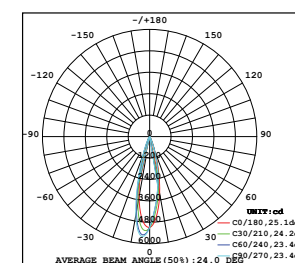

- IP20
- NOT DIMMABLE
- A+ ENERGY CLASS
- LINES 4
- 60mA 100mA\*
- INSTALLATION HEIGHT 3-5M
- SMD 2835
- 0.425Kg 0.480Kg
- VOLT 220-240V 50-60Hz
- PF >0.5
- Ra >80
- 10000 ON-OFF
- 25000h LIFE TIME
- START TIME min: 0.5 sec
- 20°C ~ +45°C OPERATING TEMP.

PRO  
2 YEARS WARRANTY

White Box with Sticker PACKING

| BARCODE       | CODE       | WATT | KELVIN | BEAM ANGLE | LUMEN / WATT | COLOR       | PACKING | PRICE (€) |
|---------------|------------|------|--------|------------|--------------|-------------|---------|-----------|
| 5207227061622 | 145-55090  | 15W  | 4000K  | 24°        | 90 lm/watt   | WHITE/BLACK | 1/20    | 86.45     |
| 5207227061646 | 145-55091* | 20W  | 4000K  | 100°       | 90 lm/watt   | WHITE       | 1/20    | 76.60     |

RECESSED LINEAR TRACK LIGHT LED • ΣΠΟΤ ΡΑΓΑΣ ΧΩΝΕΥΤΟ ΓΡΑΜΜΙΚΟ LED



**NEW!**

PRODUCTION MATERIAL: **ALUMINIUM & PC**  
ΥΛΙΚΟ ΚΑΤΑΣΚΕΥΗΣ: **ΑΛΟΥΜΙΝΙΟ & PC**  
361x40x85mm

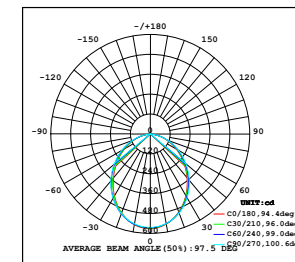

- IP20
- NOT DIMMABLE
- A+ ENERGY CLASS
- 265mA
- INSTALLATION HEIGHT 3-5M
- Cutting dimension 350x65mm
- SMD 3030
- 0.500Kg
- VOLT 220-240V 50-60Hz
- PF >0.5
- BEAM ANGLE 24°
- Ra >80
- 10000 ON-OFF
- 25000h LIFE TIME
- START TIME min: 0.5 sec
- 20°C ~ +45°C OPERATING TEMP.

PRO  
2 YEARS WARRANTY

White Box with Sticker PACKING

| BARCODE       | CODE      | WATT | KELVIN | LUMEN / WATT | COLOR       | PACKING | PRICE (€) |
|---------------|-----------|------|--------|--------------|-------------|---------|-----------|
| 5207227061660 | 145-55092 | 12W  | 4000K  | 90 lm/watt   | WHITE/BLACK | 1/20    | 74.85     |

TRACK LIGHT ACCESSORIES • ΑΞΕΣΟΥΑΡ ΣΠΟΤ ΡΑΓΑΣ

PRODUCTION MATERIAL: ALUMINIUM & PVC  
ΥΛΙΚΟ ΚΑΤΑΣΚΕΥΗΣ: ΑΛΟΥΜΙΝΙΟ & PVC

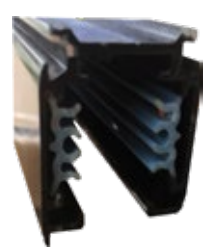

|               |           |  |  |      |           |       |  |  |
|---------------|-----------|--|--|------|-----------|-------|--|--|
| 29x38x990mm   |           |  |  |      |           |       |  |  |
| 5206139087461 | 145-55160 | RAIL UNIVERSAL 4 LINES 1m WHITE<br>ΡΑΓΑ UNIVERSAL 4 ΓΡΑΜΜΩΝ 1m ΛΕΥΚΗ |  | 1/10 | PRICE (€) |       |  |  |
|               |           |  |  |      |           | 31.85 |  |  |
| 5206139087485 | 145-55161 | RAIL UNIVERSAL 4 LINES 1m BLACK<br>ΡΑΓΑ UNIVERSAL 4 ΓΡΑΜΜΩΝ 1m ΜΑΥΡΗ |  | 1/10 | PRICE (€) |       |  |  |
|               |           |  |  |      |           | 31.85 |  |  |

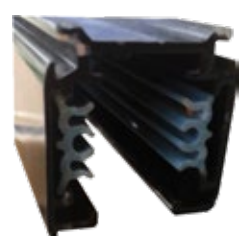

|               |           |  |  |      |           |       |  |  |
|---------------|-----------|--|--|------|-----------|-------|--|--|
| 30x35x2000mm  |           |  |  |      |           |       |  |  |
| 5206139087614 | 145-55162 | RAIL UNIVERSAL 4 LINES 2m WHITE<br>ΡΑΓΑ UNIVERSAL 4 ΓΡΑΜΜΩΝ 2m ΛΕΥΚΗ |  | 1/10 | PRICE (€) |       |  |  |
|               |           |  |  |      |           | 56.55 |  |  |
| 5206139087386 | 145-55163 | RAIL UNIVERSAL 4 LINES 2m BLACK<br>ΡΑΓΑ UNIVERSAL 4 ΓΡΑΜΜΩΝ 2m ΜΑΥΡΗ |  | 1/10 | PRICE (€) |       |  |  |
|               |           |  |  |      |           | 56.55 |  |  |



|               |           |  |  |     |           |      |  |  |
|---------------|-----------|--|--|-----|-----------|------|--|--|
|               |           |  |  |     |           |      |  |  |
| 5206139087393 | 145-55164 | POWER RAIL UNIVERSAL 4 LINES WHITE<br>ΤΡΟΦΟΔΟΣΙΑ ΡΑΓΑΣ UNIVERSAL 4 ΓΡΑΜΜΩΝ ΛΕΥΚΗ |  | 1/1 | PRICE (€) |      |  |  |
|               |           |  |  |     |           | 6.35 |  |  |
| 5206139087423 | 145-55165 | POWER RAIL UNIVERSAL 4 LINES BLACK<br>ΤΡΟΦΟΔΟΣΙΑ ΡΑΓΑΣ UNIVERSAL 4 ΓΡΑΜΜΩΝ ΜΑΥΡΗ |  | 1/1 | PRICE (€) |      |  |  |
|               |           |  |  |     |           | 6.35 |  |  |



|               |           |   |  |     |           |       |  |  |
|---------------|-----------|---|--|-----|-----------|-------|--|--|
|               |           |   |  |     |           |       |  |  |
| 5206139087430 | 145-55166 | CONJUNCTION RAIL UNIVERSAL 4 LINES STRAIGHT WHITE<br>ΣΥΝΔΕΣΜΟΣ ΡΑΓΑΣ UNIVERSAL 4 ΓΡΑΜΜΩΝ ΕΥΘΕΙΑΣ ΛΕΥΚΟΣ |  | 1/1 | PRICE (€) |       |  |  |
|               |           |   |  |     |           | 14.60 |  |  |
| 5206139087492 | 145-55167 | CONJUNCTION RAIL UNIVERSAL 4 LINES STRAIGHT BLACK<br>ΣΥΝΔΕΣΜΟΣ ΡΑΓΑΣ UNIVERSAL 4 ΓΡΑΜΜΩΝ ΕΥΘΕΙΑΣ ΜΑΥΡΟΣ |  | 1/1 | PRICE (€) |       |  |  |
|               |           |   |  |     |           | 14.60 |  |  |



|               |           |   |  |     |           |       |  |  |
|---------------|-----------|---|--|-----|-----------|-------|--|--|
|               |           |   |  |     |           |       |  |  |
| 5206139087607 | 145-55168 | FLEXIBLE L-SHAPE CONJUNCTION RAIL UNIVERSAL 4 LINES WHITE<br>ΜΕΤΑΒΛΗΤΟΣ ΣΥΝΔΕΣΜΟΣ ΡΑΓΑΣ 4 ΓΡΑΜΜΩΝ ΓΩΝΙΑΣ "L" ΛΕΥΚΟΣ |  | 1/1 | PRICE (€) |       |  |  |
|               |           |   |  |     |           | 16.75 |  |  |
| 5206139087645 | 145-55169 | FLEXIBLE L-SHAPE CONJUNCTION RAIL UNIVERSAL 4 LINES BLACK<br>ΜΕΤΑΒΛΗΤΟΣ ΣΥΝΔΕΣΜΟΣ ΡΑΓΑΣ 4 ΓΡΑΜΜΩΝ ΓΩΝΙΑΣ "L" ΜΑΥΡΟΣ |  | 1/1 | PRICE (€) |       |  |  |
|               |           |   |  |     |           | 16.75 |  |  |

TRACK LIGHT ACCESSORIES • ΑΞΕΣΟΥΑΡ ΣΠΟΤ ΡΑΓΑΣ

PRODUCTION MATERIAL: ALUMINIUM & PVC  
ΥΛΙΚΟ ΚΑΤΑΣΚΕΥΗΣ: ΑΛΟΥΜΙΝΙΟ & PVC



|               |           |   |  |     |           |       |  |  |
|---------------|-----------|---|--|-----|-----------|-------|--|--|
|               |           |   |  |     |           |       |  |  |
| 5206139088383 | 145-55170 | CONJUNCTION RAIL UNIVERSAL 4 LINES ANGLE 90° WHITE<br>ΣΥΝΔΕΣΜΟΣ ΡΑΓΑΣ UNIVERSAL 4 ΓΡΑΜΜΩΝ ΓΩΝΙΑΣ 90° ΛΕΥΚΟΣ |  | 1/1 | PRICE (€) |       |  |  |
|               |           |   |  |     |           | 11.45 |  |  |
| 5206139088390 | 145-55171 | CONJUNCTION RAIL UNIVERSAL 4 LINES ANGLE 90° BLACK<br>ΣΥΝΔΕΣΜΟΣ ΡΑΓΑΣ UNIVERSAL 4 ΓΡΑΜΜΩΝ ΓΩΝΙΑΣ 90° ΜΑΥΡΟΣ |  | 1/1 | PRICE (€) |       |  |  |
|               |           |   |  |     |           | 11.45 |  |  |



|               |           |   |  |     |           |       |  |  |
|---------------|-----------|---|--|-----|-----------|-------|--|--|
|               |           |   |  |     |           |       |  |  |
| 5206139088406 | 145-55172 | CONJUNCTION RAIL UNIVERSAL 4 LINES TYPE "CROSS" WHITE<br>ΣΥΝΔΕΣΜΟΣ ΡΑΓΑΣ UNIVERSAL 4 ΓΡΑΜΜΩΝ ΣΤΑΥΡΟΣ ΛΕΥΚΟΣ |  | 1/1 | PRICE (€) |       |  |  |
|               |           |   |  |     |           | 26.85 |  |  |
| 5206139088444 | 145-55173 | CONJUNCTION RAIL UNIVERSAL 4 LINES TYPE "CROSS" BLACK<br>ΣΥΝΔΕΣΜΟΣ ΡΑΓΑΣ UNIVERSAL 4 ΓΡΑΜΜΩΝ ΣΤΑΥΡΟΣ ΜΑΥΡΟΣ |  | 1/1 | PRICE (€) |       |  |  |
|               |           |   |  |     |           | 26.85 |  |  |



|               |           |   |  |     |           |       |  |  |
|---------------|-----------|---|--|-----|-----------|-------|--|--|
|               |           |   |  |     |           |       |  |  |
| 5206139088482 | 145-55174 | CONJUNCTION RAIL UNIVERSAL 4 LINES SPIRAL ANGLE WHITE<br>ΣΥΝΔΕΣΜΟΣ ΡΑΓΑΣ UNIVERSAL 4 ΓΡΑΜΜΩΝ ΓΩΝΙΑΣ ΣΠΙΡΑΛ ΛΕΥΚΟΣ |  | 1/1 | PRICE (€) |       |  |  |
|               |           |   |  |     |           | 21.50 |  |  |
| 5206139088567 | 145-55175 | CONJUNCTION RAIL UNIVERSAL 4 LINES SPIRAL ANGLE BLACK<br>ΣΥΝΔΕΣΜΟΣ ΡΑΓΑΣ UNIVERSAL 4 ΓΡΑΜΜΩΝ ΓΩΝΙΑΣ ΣΠΙΡΑΛ ΜΑΥΡΟΣ |  | 1/1 | PRICE (€) |       |  |  |
|               |           |   |  |     |           | 21.50 |  |  |



|               |           |   |  |     |           |       |  |  |
|---------------|-----------|---|--|-----|-----------|-------|--|--|
|               |           |   |  |     |           |       |  |  |
| 5206139088581 | 145-55176 | CONJUNCTION RAIL UNIVERSAL 4 LINES TYPE "T" WHITE<br>ΣΥΝΔΕΣΜΟΣ ΡΑΓΑΣ UNIVERSAL 4 ΓΡΑΜΜΩΝ ΤΑΦ ΛΕΥΚΟΣ |  | 1/1 | PRICE (€) |       |  |  |
|               |           |   |  |     |           | 19.20 |  |  |
| 5206139088598 | 145-55177 | CONJUNCTION RAIL UNIVERSAL 4 LINES TYPE "T" BLACK<br>ΣΥΝΔΕΣΜΟΣ ΡΑΓΑΣ UNIVERSAL 4 ΓΡΑΜΜΩΝ ΤΑΦ ΜΑΥΡΟΣ |  | 1/1 | PRICE (€) |       |  |  |
|               |           |   |  |     |           | 19.20 |  |  |



|               |           |   |  |       |           |       |
|---------------|-----------|---|--|-------|-----------|-------|
|               |           |   |  |       |           |       |
| 5207227071973 | 145-55180 | ADAPTOR RAIL 4 WIRE WITH WIRE WHITE<br>ΑΝΤΑΠΤΟΡΑΣ ΡΑΓΑΣ 4 ΓΡΑΜΜΩΝ ΜΕ ΚΑΛΩΔΙΟ ΛΕΥΚΟΣ |  | 1/100 | PRICE (€) |       |
|               |           |   |  |       |           | 13.25 |
| 5207227071980 | 145-55181 | ADAPTOR RAIL 4 WIRE WITH WIRE BLACK<br>ΑΝΤΑΠΤΟΡΑΣ ΡΑΓΑΣ 4 ΓΡΑΜΜΩΝ ΜΕ ΚΑΛΩΔΙΟ ΜΑΥΡΟΣ |  | 1/100 | PRICE (€) |       |
|               |           |   |  |       |           | 13.25 |



|               |           |  |  |     |           |      |  |  |
|---------------|-----------|--|--|-----|-----------|------|--|--|
|               |           |  |  |     |           |      |  |  |
| 5206139088604 | 145-55178 | RAIL UNIVERSAL 4 LINES TERMINAL WHITE<br>ΤΕΡΜΑΤΙΚΟ ΡΑΓΑΣ UNIVERSAL 4 ΓΡΑΜΜΩΝ ΛΕΥΚΟ |  | 1/1 | PRICE (€) |      |  |  |
|               |           |  |  |     |           | 0.80 |  |  |
| 5206139088628 | 145-55179 | RAIL UNIVERSAL 4 LINES TERMINAL BLACK<br>ΤΕΡΜΑΤΙΚΟ ΡΑΓΑΣ UNIVERSAL 4 ΓΡΑΜΜΩΝ ΜΑΥΡΟ |  | 1/1 | PRICE (€) |      |  |  |
|               |           |  |  |     |           | 0.80 |  |  |

TRACK LIGHT • ΣΠΟΤ ΡΑΓΑΣ

PRODUCTION MATERIAL: ALUMINIUM & PLASTIC  
ΥΛΙΚΟ ΚΑΤΑΣΚΕΥΗΣ: ΑΛΟΥΜΙΝΙΟ & ΠΛΑΣΤΙΚΟ

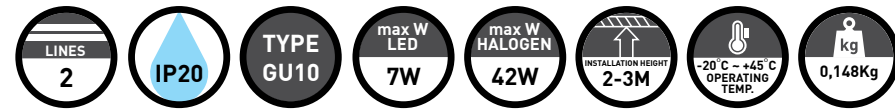

|               |           |   |      |           |
|---------------|-----------|---|------|-----------|
| 5206139079565 | 145-55050 | SPOT LIGHT UNIVERSAL 2 LINES ALUMINIUM 4cm WHITE ø34mm<br>ΣΠΟΤ ΡΑΓΑΣ UNIVERSAL 2 ΓΡΑΜΜΩΝ ΑΛΟΥΜΙΝΙΟΥ 4cm ΛΕΥΚΟ ø34mm       | 1/20 | PRICE (€) |
|               |           |   |      | 16.25     |
| 5207227008450 | 145-55060 | SPOT LIGHT UNIVERSAL 2 LINES ALUMINIUM SHORT 4cm BLACK ø34mm<br>ΣΠΟΤ ΡΑΓΑΣ UNIVERSAL 2 ΓΡΑΜΜΩΝ ΑΛΟΥΜΙΝΙΟΥ 4cm ΜΑΥΡΟ ø34mm | 1/20 | PRICE (€) |
|               |           |   |      | 16.25     |



White Box with Sticker PACKING

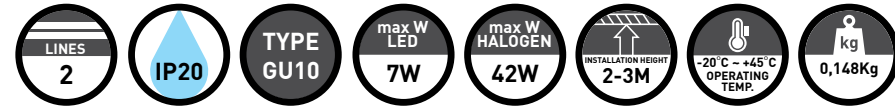

|               |           |  |      |           |
|---------------|-----------|--|------|-----------|
| 5206139079541 | 145-55051 | TRACK LIGHT UNIVERSAL 2 LINES ALUMINIUM 4cm WHITE ø34mm<br>ΣΠΟΤ ΡΑΓΑΣ UNIVERSAL 2 ΓΡΑΜΜΩΝ ΑΛΟΥΜΙΝΙΟΥ 4cm ΛΕΥΚΟ ø34mm | 1/20 | PRICE (€) |
|               |           |  |      | 16.25     |
| 5207227008474 | 145-55061 | TRACK LIGHT UNIVERSAL 2 LINES ALUMINIUM 4cm BLACK ø34mm<br>ΣΠΟΤ ΡΑΓΑΣ UNIVERSAL 2 ΓΡΑΜΜΩΝ ΑΛΟΥΜΙΝΙΟΥ 4cm ΜΑΥΡΟ ø34mm | 1/20 | PRICE (€) |
|               |           |  |      | 16.25     |



White Box with Sticker PACKING

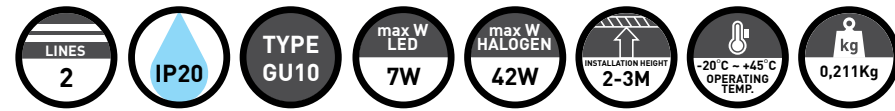

|               |           |  |      |           |
|---------------|-----------|--|------|-----------|
| 5206139079558 | 145-55052 | TRACK LIGHT UNIVERSAL 2 LINES ALUMINIUM 12cm WHITE ø35mm<br>ΣΠΟΤ ΡΑΓΑΣ UNIVERSAL 2 ΓΡΑΜΜΩΝ ΑΛΟΥΜΙΝΙΟΥ 12cm ΛΕΥΚΟ ø35mm | 1/20 | PRICE (€) |
|               |           |  |      | 17.85     |
| 5207227008498 | 145-55062 | TRACK LIGHT UNIVERSAL 2 LINES ALUMINIUM 12cm BLACK ø35mm<br>ΣΠΟΤ ΡΑΓΑΣ UNIVERSAL 2 ΓΡΑΜΜΩΝ ΑΛΟΥΜΙΝΙΟΥ 12cm ΜΑΥΡΟ ø35mm | 1/20 | PRICE (€) |
|               |           |  |      | 17.85     |



White Box with Sticker PACKING

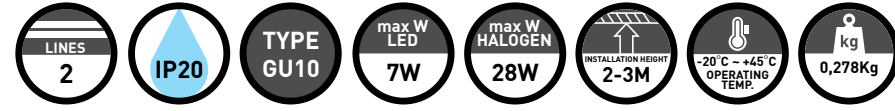

|               |           |  |      |           |
|---------------|-----------|--|------|-----------|
| 5207227065774 | 145-55053 | TRACK LIGHT 2 LINE WHITE ø60x100mm<br>ΣΠΟΤ ΡΑΓΑΣ 2 ΓΡΑΜΜΩΝ ΛΕΥΚΟ ø60x100mm | 1/24 | PRICE (€) |
|               |           |  |      | 26.85     |
| 5207227065811 | 145-55063 | TRACK LIGHT 2 LINE BLACK ø60x100mm<br>ΣΠΟΤ ΡΑΓΑΣ 2 ΓΡΑΜΜΩΝ ΜΑΥΡΟ ø60x100mm | 1/24 | PRICE (€) |
|               |           |  |      | 26.85     |



White Box with Sticker PACKING

TRACK LIGHT • ΣΠΟΤ ΡΑΓΑΣ

PRODUCTION MATERIAL: ALUMINIUM & PLASTIC  
ΥΛΙΚΟ ΚΑΤΑΣΚΕΥΗΣ: ΑΛΟΥΜΙΝΙΟ & ΠΛΑΣΤΙΚΟ

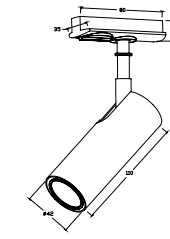

|               |           |  |      |           |
|---------------|-----------|--|------|-----------|
| 5207227065798 | 145-55054 | TRACK LIGHT 2 LINE GU10 WHITE ø42x110mm<br>ΣΠΟΤ ΡΑΓΑΣ 2 ΓΡΑΜΜΩΝ GU10 ΛΕΥΚΟ ø42x110mm | 1/24 | PRICE (€) |
|               |           |  |      | 22.45     |
| 5207227065828 | 145-55064 | TRACK LIGHT 2 LINE GU10 BLACK ø42x110mm<br>ΣΠΟΤ ΡΑΓΑΣ 2 ΓΡΑΜΜΩΝ GU10 ΜΑΥΡΟ ø42x110mm | 1/24 | PRICE (€) |
|               |           |  |      | 22.45     |



White Box with Sticker PACKING

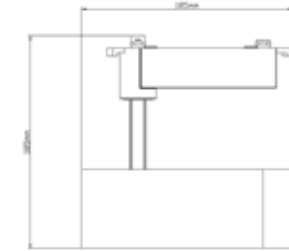

PRODUCTION MATERIAL: ALUMINIUM & PLASTIC  
ΥΛΙΚΟ ΚΑΤΑΣΚΕΥΗΣ: ΑΛΟΥΜΙΝΙΟ & ΠΛΑΣΤΙΚΟ



|               |                     |            |        |              |       |          |           |        |       |           |        |                 |         |                               |
|---------------|---------------------|------------|--------|--------------|-------|----------|-----------|--------|-------|-----------|--------|-----------------|---------|-------------------------------|
| VOLT          | 170-265V<br>50-60Hz | BEAM ANGLE | 35°    | PF           | >0.5  | Ra (CRI) | >80       | ON-OFF | 15000 | LIFE TIME | 50000h | START TIME min: | 0.5 sec | -20°C ~ +45°C OPERATING TEMP. |
| BARCODE       | CODE                | WATT       | KELVIN | LUMEN / WATT | COLOR | PACKING  | PRICE (€) |        |       |           |        |                 |         |                               |
| 5207227067471 | 145-55080           | 20W        | 4000K  | 85 lm/watt   | WHITE | 1/30     | 38.80     |        |       |           |        |                 |         |                               |
| 5207227067495 | 145-55081           | 20W        | 4000K  | 85 lm/watt   | BLACK | 1/30     | 38.80     |        |       |           |        |                 |         |                               |



White Box with Sticker PACKING



ø40x368x36mm



|               |                    |            |        |              |       |          |           |        |       |           |        |                 |         |                               |
|---------------|--------------------|------------|--------|--------------|-------|----------|-----------|--------|-------|-----------|--------|-----------------|---------|-------------------------------|
| VOLT          | 85-265V<br>50-60Hz | BEAM ANGLE | 30°    | PF           | >0.9  | Ra (CRI) | >85       | ON-OFF | 15000 | LIFE TIME | 30000h | START TIME min: | 0.5 sec | -20°C ~ +45°C OPERATING TEMP. |
| BARCODE       | CODE               | WATT       | KELVIN | LUMEN / WATT | COLOR | PACKING  | PRICE (€) |        |       |           |        |                 |         |                               |
| 5207227013898 | 145-55036          | 3W         | 4000K  | 90 lm/watt   | WHITE | 1/36     | 19.85     |        |       |           |        |                 |         |                               |
| 5207227013911 | 145-55037          | 3W         | 4000K  | 90 lm/watt   | BLACK | 1/36     | 19.85     |        |       |           |        |                 |         |                               |

PRODUCTION MATERIAL: ALUMINIUM & PVC  
ΥΛΙΚΟ ΚΑΤΑΣΚΕΥΗΣ: ΑΛΟΥΜΙΝΙΟ & PVC

FLEXIBLE UNIVERSAL



White Box with Sticker PACKING

## RAIL UNIVERSAL & ACCESSORIES • ΡΑΓΑ UNIVERSAL & ΑΞΕΣΟΥΑΡ

PRODUCTION MATERIAL: **ALUMINIUM & PVC**  
ΥΛΙΚΟ ΚΑΤΑΣΚΕΥΗΣ: **ΑΛΟΥΜΙΝΙΟ & PVC**

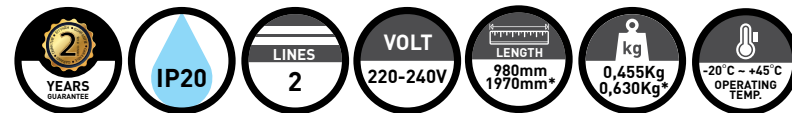
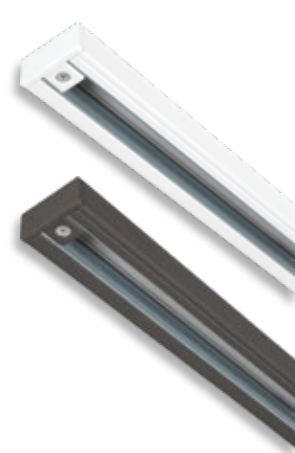

| Code          | Color      | Description  | Quantity | Price (€) |
|---------------|------------|--|----------|-----------|
| 5206139079671 | 145-55130  | RAIL UNIVERSAL 2 LINES WHITE 35x20x980mm<br>ΡΑΓΑ UNIVERSAL 2 ΓΡΑΜΜΩΝ ΛΕΥΚΗ 35x20x980mm   | 1/20     | 12.85     |
| 5206139079688 | 145-55131  | RAIL UNIVERSAL 2 LINES BLACK 35x20x980mm<br>ΡΑΓΑ UNIVERSAL 2 ΓΡΑΜΜΩΝ ΜΑΥΡΗ 35x20x980mm   | 1/20     | 12.85     |
| 5206139079695 | 145-55132* | RAIL UNIVERSAL 2 LINES WHITE 35x16x1970mm<br>ΡΑΓΑ UNIVERSAL 2 ΓΡΑΜΜΩΝ ΛΕΥΚΗ 35x16x1970mm | 1/20     | 22.60     |
| 5206139079701 | 145-55133* | RAIL UNIVERSAL 2 LINES BLACK 35x16x1970mm<br>ΡΑΓΑ UNIVERSAL 2 ΓΡΑΜΜΩΝ ΜΑΥΡΗ 35x16x1970mm | 1/20     | 22.60     |

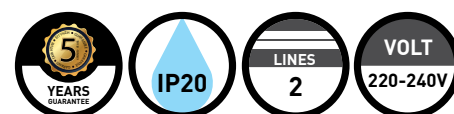

| Code          | Color     | Description  | Quantity | Price (€) |
|---------------|-----------|--|----------|-----------|
| 5206139079718 | 145-55134 | POWER RAIL UNIVERSAL 2 LINES WHITE / 0.052 Kg<br>ΤΡΟΦΟΔΟΣΙΑ ΡΑΓΑΣ UNIVERSAL 2 ΓΡΑΜΜΩΝ ΛΕΥΚΗ / 0.052 Kg | 1/1      | 5.95      |
| 5206139079725 | 145-55135 | POWER RAIL UNIVERSAL 2 LINES BLACK / 0.052 Kg<br>ΤΡΟΦΟΔΟΣΙΑ ΡΑΓΑΣ UNIVERSAL 2 ΓΡΑΜΜΩΝ ΜΑΥΡΗ / 0.052 Kg | 1/1      | 5.95      |



| Code          | Color     | Description   | Quantity | Price (€) |
|---------------|-----------|---|----------|-----------|
| 5206139079732 | 145-55136 | CONJUNCTION RAIL UNIVERSAL 2 LINES STRAIGHT WHITE / 0.027 Kg<br>ΣΥΝΔΕΣΜΟΣ ΡΑΓΑΣ UNIVERSAL 2 ΓΡΑΜΜΩΝ ΕΥΘΕΙΑΣ ΛΕΥΚΟΣ / 0.027 Kg     | 1/1      | 5.95      |
| 5206139079749 | 145-55137 | CONJUNCTION RAIL UNIVERSAL 2 LINES STRAIGHT BLACK / 0.027 Kg<br>ΣΥΝΔΕΣΜΟΣ ΡΑΓΑΣ UNIVERSAL 2 ΓΡΑΜΜΩΝ ΕΥΘΕΙΑΣ ΜΑΥΡΟΣ / 0.027 Kg     | 1/1      | 5.95      |
| 5206139079756 | 145-55138 | CONJUNCTION RAIL UNIVERSAL 2 LINES ANGLE 90° WHITE / 0.027 Kg<br>ΣΥΝΔΕΣΜΟΣ ΡΑΓΑΣ UNIVERSAL 2 ΓΡΑΜΜΩΝ ΓΩΝΙΑΣ 90° ΛΕΥΚΟΣ / 0.027 Kg | 1/1      | 3.45      |
| 5206139079763 | 145-55139 | CONJUNCTION RAIL UNIVERSAL 2 LINES ANGLE 90° BLACK / 0.027 Kg<br>ΣΥΝΔΕΣΜΟΣ ΡΑΓΑΣ UNIVERSAL 2 ΓΡΑΜΜΩΝ ΓΩΝΙΑΣ 90° ΜΑΥΡΟΣ / 0.027 Kg | 1/1      | 3.45      |



| Code          | Color     | Description   | Quantity | Price (€) |
|---------------|-----------|---|----------|-----------|
| 5206139079855 | 145-55140 | CONJUNCTION RAIL UNIVERSAL 2 LINES TYPE "CROSS" WHITE / 0.040 Kg<br>ΣΥΝΔΕΣΜΟΣ ΡΑΓΑΣ UNIVERSAL 2 ΓΡΑΜΜΩΝ ΣΤΑΥΡΟΣ ΛΕΥΚΟΣ / 0.040 Kg | 1/1      | 5.55      |
| 5206139079862 | 145-55141 | CONJUNCTION RAIL UNIVERSAL 2 LINES TYPE "CROSS" BLACK / 0.040 Kg<br>ΣΥΝΔΕΣΜΟΣ ΡΑΓΑΣ UNIVERSAL 2 ΓΡΑΜΜΩΝ ΣΤΑΥΡΟΣ ΜΑΥΡΟΣ / 0.040 Kg | 1/1      | 5.55      |
| 5206139079893 | 145-55144 | CONJUNCTION RAIL UNIVERSAL 2 LINES TYPE "T" WHITE / 0.033 Kg<br>ΣΥΝΔΕΣΜΟΣ ΡΑΓΑΣ UNIVERSAL 2 ΓΡΑΜΜΩΝ ΤΑΦ ΛΕΥΚΟΣ / 0.033 Kg         | 1/1      | 4.20      |
| 5206139079909 | 145-55145 | CONJUNCTION RAIL UNIVERSAL 2 LINES TYPE "T" BLACK / 0.033 Kg<br>ΣΥΝΔΕΣΜΟΣ ΡΑΓΑΣ UNIVERSAL 2 ΓΡΑΜΜΩΝ ΤΑΦ ΜΑΥΡΟΣ / 0.033 Kg         | 1/1      | 4.20      |

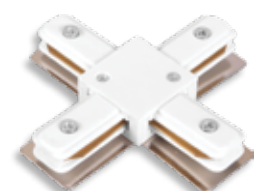

| Code          | Color     | Description   | Quantity | Price (€) |
|---------------|-----------|---|----------|-----------|
| 5206139079879 | 145-55142 | CONJUNCTION RAIL UNIVERSAL 2 LINES SPIRAL ANGLE WHITE / 0.113 Kg<br>ΣΥΝΔΕΣΜΟΣ ΡΑΓΑΣ UNIVERSAL 2 ΓΡΑΜΜΩΝ ΓΩΝΙΑΣ ΣΠΙΡΑΛ ΛΕΥΚΟΣ / 0.113 Kg | 1/1      | 17.40     |
| 5206139079886 | 145-55143 | CONJUNCTION RAIL UNIVERSAL 2 LINES SPIRAL ANGLE BLACK / 0.113 Kg<br>ΣΥΝΔΕΣΜΟΣ ΡΑΓΑΣ UNIVERSAL 2 ΓΡΑΜΜΩΝ ΓΩΝΙΑΣ ΣΠΙΡΑΛ ΜΑΥΡΟΣ / 0.113 Kg | 1/1      | 17.40     |



| Code          | Color     | Description  | Quantity | Price (€) |
|---------------|-----------|--|----------|-----------|
| 5206139079916 | 145-55146 | RAIL UNIVERSAL 2 LINES TERMINAL WHITE / 0.006 Kg<br>ΤΕΡΜΑΤΙΚΟ ΡΑΓΑΣ UNIVERSAL 2 ΓΡΑΜΜΩΝ ΛΕΥΚΟ / 0.006 Kg | 1/1      | 2.15      |
| 5206139079923 | 145-55147 | RAIL UNIVERSAL 2 LINES TERMINAL BLACK / 0.006 Kg<br>ΤΕΡΜΑΤΙΚΟ ΡΑΓΑΣ UNIVERSAL 2 ΓΡΑΜΜΩΝ ΜΑΥΡΟ / 0.006 Kg | 1/1      | 2.15      |

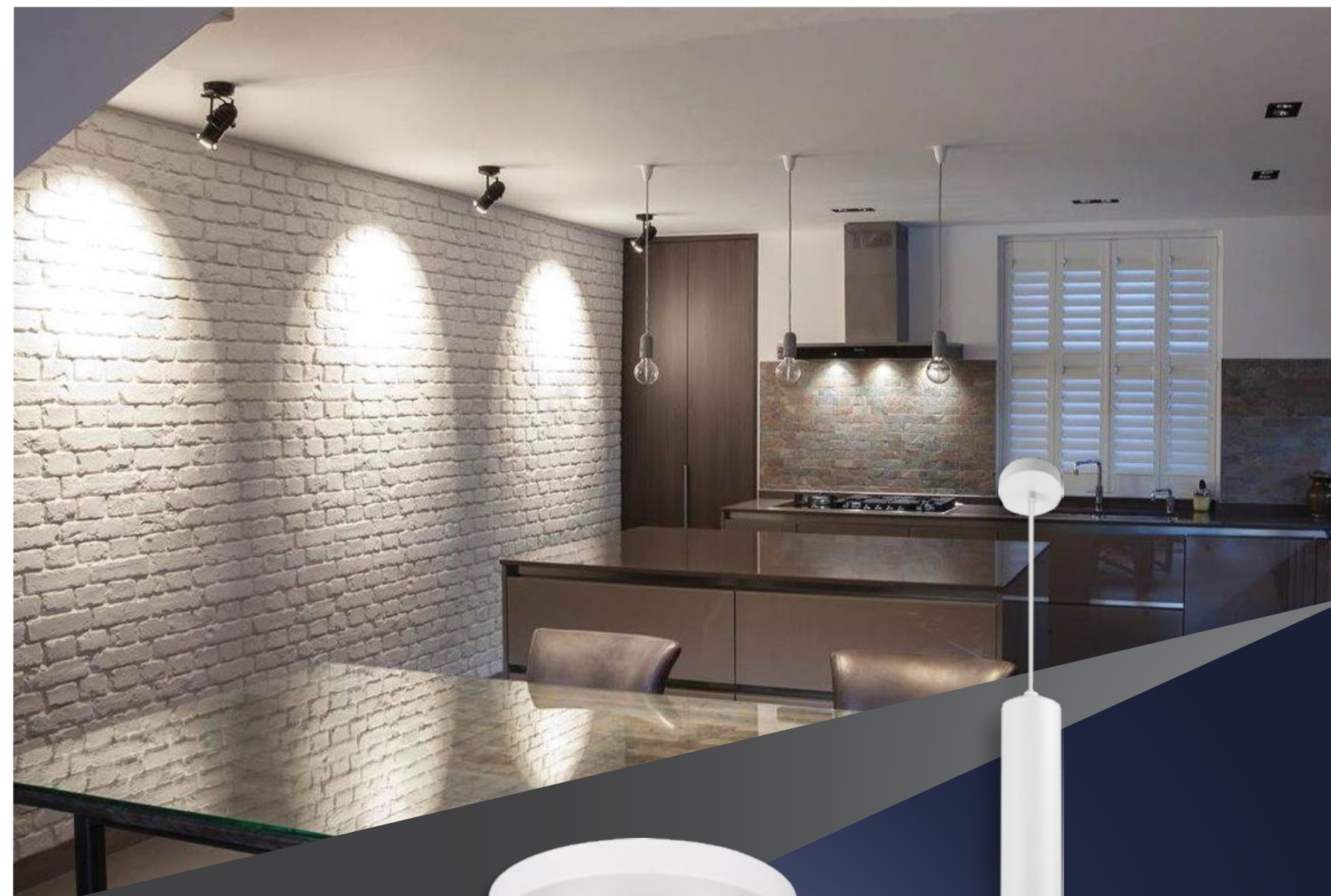

### Σποτ Εξωτερικά LED

για Επαγγελματική Χρήση

### Ceiling Spots LED

for Professional use

Ιδανικοί για χρήση σε χώρους όπως:

- Κατοικίες
- Καταστήματα
- Εμπορικά Κέντρα
- Αποθήκες
- Βιοτεχνικούς Χώρους
- Βιομηχανικούς Χώρους
- Μοτέλ
- Ξενοδοχεία
- Αίθουσες Διδασκαλίας
- Εκθεσιακούς Χώρους
- Μουσεία
- Αρχιτεκτονικές Δομές
- Δημόσιες Εγκαταστάσεις

Ideal for use in places as:

- Residences
- Stores
- Shopping Malls
- Warehouses
- Business Areas
- Industrial Areas
- Motels
- Hotels
- Teaching Rooms
- Exhibitions
- Museums
- Architectural Structures
- Public Facilities

CEILING SPOT ROSETTE • ΣΠΟΤ ΟΡΟΦΗΣ ΡΟΖΕΤΑ

PRODUCTION MATERIAL: **STEEL**  
ΥΛΙΚΟ ΚΑΤΑΣΚΕΥΗΣ: **ΑΤΣΑΛΙ**



2 YEARS WARRANTY  
IP20  
TYPE GU10  
max W LED 7W  
max W HALOGEN 28W  
-20°C ~ +45°C OPERATING TEMP.  
0,287Kg

5207227065514 145-25000 CEILING SPOT ROSETTE SINGLE SLIM WHITE 80x12.5x115mm ΣΠΟΤ ΟΡΟΦΗΣ ΡΟΖΕΤΑ ΜΟΝΗ SLIM ΛΕΥΚΗ 80x12.5x115mm 1/24



PRICE (€)  
16.75

5207227065538 145-25001 CEILING SPOT ROSETTE SINGLE SLIM BLACK 80x12.5x115mm ΣΠΟΤ ΟΡΟΦΗΣ ΡΟΖΕΤΑ ΜΟΝΗ SLIM ΜΑΥΡΗ 80x12.5x115mm 1/24

PRICE (€)  
16.75



2 YEARS WARRANTY  
IP20  
TYPE GU10  
max W LED 7W  
max W HALOGEN 28W  
-20°C ~ +45°C OPERATING TEMP.  
0,620Kg

5207227065552 145-25002 CEILING SPOT ROSETTE DOUBLE SLIM WHITE 18x18x115mm ΣΠΟΤ ΟΡΟΦΗΣ ΡΟΖΕΤΑ ΔΙΠΛΗ SLIM ΛΕΥΚΗ 18x18x115mm 1/12



PRICE (€)  
33.40

5207227065576 145-25003 CEILING SPOT ROSETTE DOUBLE SLIM BLACK 18x18x115mm ΣΠΟΤ ΟΡΟΦΗΣ ΡΟΖΕΤΑ ΔΙΠΛΗ SLIM ΜΑΥΡΗ 18x18x115mm 1/12

PRICE (€)  
33.40



2 YEARS WARRANTY  
IP20  
TYPE GU10  
max W LED 7W  
max W HALOGEN 28W  
-20°C ~ +45°C OPERATING TEMP.  
0,943Kg

5207227065590 145-25004 CEILING SPOT ROSETTE TRIPLE SLIM WHITE 24x24x115mm ΣΠΟΤ ΟΡΟΦΗΣ ΡΟΖΕΤΑ ΤΡΙΠΛΗ SLIM ΛΕΥΚΗ 24x24x115mm 1/6



PRICE (€)  
48.60

5207227065613 145-25005 CEILING SPOT ROSETTE TRIPLE SLIM BLACK 24x24x115mm ΣΠΟΤ ΟΡΟΦΗΣ ΡΟΖΕΤΑ ΤΡΙΠΛΗ SLIM ΜΑΥΡΗ 24x24x115mm 1/6

PRICE (€)  
48.60

PRODUCTION MATERIAL: **ALUMINIUM & STEEL**  
ΥΛΙΚΟ ΚΑΤΑΣΚΕΥΗΣ: **ΑΛΟΥΜΙΝΙΟ & ΑΤΣΑΛΙ**



2 YEARS WARRANTY  
IP20  
TYPE GU10  
max W LED 7W  
max W HALOGEN 28W  
-20°C ~ +45°C OPERATING TEMP.  
0,394Kg

5207227065712 145-25010 CEILING SPOT ROSETTE SINGLE WHITE/ BLACK 10x12x115mm ΣΠΟΤ ΟΡΟΦΗΣ ΡΟΖΕΤΑ ΜΟΝΗ ΛΕΥΚΗ/ ΜΑΥΡΗ 10x12x115mm 1/24



PRICE (€)  
28.15



2 YEARS WARRANTY  
IP20  
TYPE GU10  
max W LED 7W  
max W HALOGEN 28W  
-20°C ~ +45°C OPERATING TEMP.  
0,770Kg

5207227065736 145-25011 CEILING SPOT ROSETTE DOUBLE WHITE/ BLACK 18x18x115mm ΣΠΟΤ ΟΡΟΦΗΣ ΡΟΖΕΤΑ ΔΙΠΛΗ ΛΕΥΚΗ/ ΜΑΥΡΗ 18x18x115mm 1/12



PRICE (€)  
54.60



2 YEARS WARRANTY  
IP20  
TYPE GU10  
max W LED 7W  
max W HALOGEN 28W  
-20°C ~ +45°C OPERATING TEMP.  
1,043Kg

5207227065750 145-25012 CEILING SPOT ROSETTE TRIPLE WHITE/ BLACK 24x24x115mm ΣΠΟΤ ΟΡΟΦΗΣ ΡΟΖΕΤΑ ΤΡΙΠΛΗ ΛΕΥΚΗ/ ΜΑΥΡΗ 24x24x115mm 1/6



PRICE (€)  
79.60

CEILING SPOT BAR • ΣΠΟΤ ΟΡΟΦΗΣ ΜΠΑΡΑ

PRODUCTION MATERIAL: **ALUMINIUM & STEEL**  
ΥΛΙΚΟ ΚΑΤΑΣΚΕΥΗΣ: **ΑΛΟΥΜΙΝΙΟ & ΑΤΣΑΛΙ**



2 YEARS WARRANTY  
IP20  
TYPE GU10  
max W LED 7W  
max W HALOGEN 28W  
-20°C ~ +45°C OPERATING TEMP.  
0,433Kg

5207227065637 145-25006 SPOT BAR SINGLE WHITE/ BLACK 11,5x7x115mm ΣΠΟΤ ΜΠΑΡΑ ΜΟΝΗ ΛΕΥΚΗ/ ΜΑΥΡΗ 11,5x7x115mm 1/24



PRICE (€)  
28.15



2 YEARS WARRANTY  
IP20  
TYPE GU10  
max W LED 7W  
max W HALOGEN 28W  
-20°C ~ +45°C OPERATING TEMP.  
0,850Kg

5207227065651 145-25007 SPOT BAR DOUBLE WHITE/ BLACK 30x7x115mm ΣΠΟΤ ΜΠΑΡΑ ΔΙΠΛΗ ΛΕΥΚΗ/ ΜΑΥΡΗ 30x7x115mm 1/12



PRICE (€)  
54.60



2 YEARS WARRANTY  
IP20  
TYPE GU10  
max W LED 7W  
max W HALOGEN 28W  
-20°C ~ +45°C OPERATING TEMP.  
1,372Kg

5207227065675 145-25008 SPOT BAR TRIPLE WHITE/ BLACK 52x7x115mm ΣΠΟΤ ΜΠΑΡΑ ΤΡΙΠΛΗ ΛΕΥΚΗ/ ΜΑΥΡΗ 52x7x115mm 1/12



PRICE (€)  
79.60



2 YEARS WARRANTY  
IP20  
TYPE GU10  
max W LED 7W  
max W HALOGEN 28W  
-20°C ~ +45°C OPERATING TEMP.  
1,640Kg

5207227065699 145-25009 SPOT BAR QUAD WHITE/ BLACK 72x7x115mm ΣΠΟΤ ΜΠΑΡΑ ΤΕΤΡΑΠΛΗ ΛΕΥΚΗ/ ΜΑΥΡΗ 72x7x115mm 1/6



PRICE (€)  
106.80

CEILING LED SPOT LIGHT • ΣΠΟΤ ΟΡΟΦΗΣ ΚΙΝΗΤΟ

PRODUCTION MATERIAL: **ALUMINIUM**  
ΥΛΙΚΟ ΚΑΤΑΣΚΕΥΗΣ: **ΑΛΟΥΜΙΝΙΟ**



IP20  
A+ ENERGY CLASS  
VOLT 170-265V 50-60Hz  
KELVIN 4000K  
LUMENS 85/W  
CLASS II  
INSTALLATION HEIGHT 3-4M  
COB 1313\*1919

PF >0.5  
Ra >80  
IK 08  
15000 ON-OFF  
50000h LIFE TIME  
START TIME min: 0.5 sec  
-10°C ~ +50°C OPERATING TEMP.



| BARCODE       | CODE       | WATT | AMPERAGE | BEAM ANGLE | WEIGHT   | COLOR | PACKING | PRICE (€) |
|---------------|------------|------|----------|------------|----------|-------|---------|-----------|
| 5207227067204 | 145-25200* | 10W  | 90mA     | 35°        | 1,190 Kg | WHITE | 1/40    | 24.60     |
| 5207227067228 | 145-25201* | 10W  | 90mA     | 35°        | 1,190 Kg | BLACK | 1/40    | 24.60     |
| 5207227067242 | 145-25202  | 18W  | 160mA    | 35°        | 1,390 Kg | WHITE | 1/30    | 27.60     |
| 5207227067266 | 145-25203  | 18W  | 160mA    | 35°        | 1,390 Kg | BLACK | 1/30    | 27.60     |

SPOT WALL LIGHT • ΣΠΟΤ ΤΟΙΧΟΥ

PRODUCTION MATERIAL: **ALUMINIUM**  
ΥΛΙΚΟ ΚΑΤΑΣΚΕΥΗΣ: **ΑΛΟΥΜΙΝΙΟ**

**NEW!**

2 YEARS WARRANTY

IP20

TYPE GU10

max W LED 7W

max W HALOGEN 28W

-20°C - +50°C OPERATING TEMP.

0,385Kg

White Box with Sticker PACKING

|               |           |  |      |           |       |
|---------------|-----------|--|------|-----------|-------|
| 5207227065996 | 145-25013 | CEILING LIGHT CYLINDER ø80x100 WHITE<br>ΦΩΤΙΣΤΙΚΟ ΚΥΛΙΝΔΡΟΣ ΟΡΟΦΗΣ ø80x100 ΛΕΥΚΟ | 1/20 | PRICE (€) | 24.85 |
| 5207227066016 | 145-25014 | CEILING LIGHT CYLINDER ø80x100 BLACK<br>ΦΩΤΙΣΤΙΚΟ ΚΥΛΙΝΔΡΟΣ ΟΡΟΦΗΣ ø80x100 ΜΑΥΡΟ | 1/20 | PRICE (€) | 24.85 |

**NEW!**

2 YEARS WARRANTY

IP20

TYPE GU10

max W LED 7W

max W HALOGEN 28W

-20°C - +50°C OPERATING TEMP.

0,470Kg

White Box with Sticker PACKING

|               |           |  |      |           |       |
|---------------|-----------|--|------|-----------|-------|
| 5207227066030 | 145-25015 | CEILING LIGHT SQUARE WHITE 83x83x110mm<br>ΦΩΤΙΣΤΙΚΟ ΤΕΤΡΑΓΩΝΟ ΟΡΟΦΗΣ ΛΕΥΚΟ 83x83x110mm | 1/20 | PRICE (€) | 26.30 |
| 5207227066054 | 145-25016 | CEILING LIGHT SQUARE BLACK 83x83x110mm<br>ΦΩΤΙΣΤΙΚΟ ΤΕΤΡΑΓΩΝΟ ΟΡΟΦΗΣ ΜΑΥΡΟ 83x83x110mm | 1/20 | PRICE (€) | 26.30 |

**NEW!**

2 YEARS WARRANTY

IP20

TYPE GU10

max W LED 7W

max W HALOGEN 28W

-20°C - +50°C OPERATING TEMP.

0,340Kg

White Box with Sticker PACKING

|               |           |  |      |           |       |
|---------------|-----------|--|------|-----------|-------|
| 5207227066078 | 145-25017 | CEILING LIGHT CYLINDER MOVEABLE WHITE ø70x160<br>ΦΩΤΙΣΤΙΚΟ ΚΙΝΗΤΟ ΚΥΛΙΝΔΡΟΣ ΟΡΟΦΗΣ ΛΕΥΚΟ ø70x160 | 1/30 | PRICE (€) | 34.85 |
| 5207227066092 | 145-25018 | CEILING LIGHT CYLINDER MOVEABLE BLACK ø70x160<br>ΦΩΤΙΣΤΙΚΟ ΚΙΝΗΤΟ ΚΥΛΙΝΔΡΟΣ ΟΡΟΦΗΣ ΜΑΥΡΟ ø70x160 | 1/30 | PRICE (€) | 34.85 |

**NEW!**

2 YEARS WARRANTY

IP20

TYPE GU10

max W LED 7W

max W HALOGEN 28W

-20°C - +50°C OPERATING TEMP.

0,370Kg

White Box with Sticker PACKING

|               |           |  |      |           |       |
|---------------|-----------|--|------|-----------|-------|
| 5207227066115 | 145-25019 | SPOT WALL LIGHT SINGLE ROUND WHITE ø60x120x135mm<br>ΣΠΟΤ ΤΟΙΧΟΥ ΜΟΝΟ ΣΤΡΟΓΓΥΛΟ ΛΕΥΚΟ ø60x120x135mm | 1/20 | PRICE (€) | 26.55 |
| 5207227066139 | 145-25020 | SPOT WALL LIGHT SINGLE ROUND BLACK ø60x120x135mm<br>ΣΠΟΤ ΤΟΙΧΟΥ ΜΟΝΟ ΣΤΡΟΓΓΥΛΟ ΜΑΥΡΟ ø60x120x135mm | 1/20 | PRICE (€) | 26.55 |

**NEW!**

2 YEARS WARRANTY

IP20

TYPE GU10

max W LED 7W

max W HALOGEN 28W

-20°C - +50°C OPERATING TEMP.

0,505 Kg

White Box with Sticker PACKING

|               |           |   |      |           |       |
|---------------|-----------|---|------|-----------|-------|
| 5207227066153 | 145-25021 | SPOT WALL LIGHT SINGLE SQUARE WHITE 120x60x135mm<br>ΣΠΟΤ ΤΟΙΧΟΥ ΜΟΝΟ ΤΕΤΡΑΓΩΝΟ ΛΕΥΚΟ 120x60x135mm | 1/20 | PRICE (€) | 29.65 |
| 5207227066177 | 145-25022 | SPOT WALL LIGHT SINGLE SQUARE BLACK 120x60x135mm<br>ΣΠΟΤ ΤΟΙΧΟΥ ΜΟΝΟ ΤΕΤΡΑΓΩΝΟ ΜΑΥΡΟ 120x60x135mm | 1/20 | PRICE (€) | 29.65 |

SPOT SURFACE MOVEABLE • ΣΠΟΤ ΚΙΝΗΤΑ ΕΙΣΩΤΕΡΙΚΑ

PRODUCTION MATERIAL: **ALUMINIUM**  
ΥΛΙΚΟ ΚΑΤΑΣΚΕΥΗΣ: **ΑΛΟΥΜΙΝΙΟ**

ARISTON

**NEW!**

145-25210

145-25212

IP20

A+++ ENERGY CLASS

VOLT 85-260V 50-60Hz

600mA

CLASS I

COB

INSTALLATION HEIGHT 2-3M

0,230Kg 0,210Kg\*

GROUNDING

2 YEARS WARRANTY

White Box with Sticker PACKING

BEAM ANGLE 25°

PF >0.5

Ra >70

IK 06

15000 ON-OFF

20000h LIFE TIME

START TIME min: 0.5 sec

-10°C - +40°C OPERATING TEMP.

| BARCODE       | CODE       | WATT | KELVIN | DIMENSIONS | LUMEN / WATT | COLOR | PACKING | PRICE (€) |
|---------------|------------|------|--------|------------|--------------|-------|---------|-----------|
| 5207227072208 | 145-25210  | 3W   | 3000K  | 75x120mm   | 65 lm/watt   | WHITE | 1/50    | 34.25     |
| 5207227072222 | 145-25211  | 3W   | 3000K  | 75x120mm   | 65 lm/watt   | BLACK | 1/50    | 34.25     |
| 5207227072246 | 145-25212* | 3W   | 3000K  | 75x135mm   | 65 lm/watt   | WHITE | 1/50    | 35.85     |
| 5207227072260 | 145-25213* | 3W   | 3000K  | 75x135mm   | 65 lm/watt   | BLACK | 1/50    | 35.85     |

**NEW!**

PRODUCTION MATERIAL: **ALUMINIUM**  
ΥΛΙΚΟ ΚΑΤΑΣΚΕΥΗΣ: **ΑΛΟΥΜΙΝΙΟ**

IP20

A+ ENERGY CLASS

VOLT 170-265V 50-60Hz

4000K

LUMENS 85/W

CLASS II

INSTALLATION HEIGHT 3-4M

COB 1919

2 YEARS WARRANTY

White Box with Sticker PACKING

BEAM ANGLE 90°

PF >0.5

Ra >80

IK 08

15000 ON-OFF

50000h LIFE TIME

START TIME min: 0.5 sec

-10°C - +50°C OPERATING TEMP.

| BARCODE       | CODE      | WATT | AMPERAGE | BEAM ANGLE | WEIGHT   | COLOR | PACKING | PRICE (€) |
|---------------|-----------|------|----------|------------|----------|-------|---------|-----------|
| 5207227067327 | 145-25206 | 15W  | 140mA    | 90°        | 2,270 Kg | WHITE | 1/50    | 34.85     |
| 5207227067341 | 145-25207 | 15W  | 140mA    | 90°        | 2,270 Kg | BLACK | 1/50    | 34.85     |

HANGING CEILING LIGHTS • ΦΩΤΙΣΤΙΚΑ ΚΡΕΜΑΣΤΑ



PRODUCTION MATERIAL: **ALUMINIUM**  
ΥΛΙΚΟ ΚΑΤΑΣΚΕΥΗΣ: **ΑΛΟΥΜΙΝΙΟ**



|               |           |  |      |                           |
|---------------|-----------|--|------|---------------------------|
| 5207227066191 | 145-25500 | HANGING CEILING LIGHT CYLINDER 1M WHITE ø56x300mm<br>ΦΩΤΙΣΤΙΚΟ ΚΡΕΜΑΣΤΟ ΚΥΛΙΝΔΡΟΣ 1M ΛΕΥΚΟ ø56x300mm | 1/20 | PRICE (€)<br><b>39.60</b> |
| 5207227066214 | 145-25501 | HANGING CEILING LIGHT CYLINDER 1M BLACK ø56x300mm<br>ΦΩΤΙΣΤΙΚΟ ΚΡΕΜΑΣΤΟ ΚΥΛΙΝΔΡΟΣ 1M ΜΑΥΡΟ ø56x300mm | 1/20 | PRICE (€)<br><b>39.60</b> |



PRODUCTION MATERIAL: **ALUMINIUM**  
ΥΛΙΚΟ ΚΑΤΑΣΚΕΥΗΣ: **ΑΛΟΥΜΙΝΙΟ**



|               |           |  |      |                           |
|---------------|-----------|--|------|---------------------------|
| 5207227066238 | 145-25502 | HANGING CEILING LIGHT CYLINDER 1M WHITE ø56x400mm<br>ΦΩΤΙΣΤΙΚΟ ΚΡΕΜΑΣΤΟ ΚΥΛΙΝΔΡΟΣ 1M ΛΕΥΚΟ ø56x400mm | 1/10 | PRICE (€)<br><b>46.60</b> |
| 5207227066252 | 145-25503 | HANGING CEILING LIGHT CYLINDER 1M BLACK ø56x400mm<br>ΦΩΤΙΣΤΙΚΟ ΚΡΕΜΑΣΤΟ ΚΥΛΙΝΔΡΟΣ 1M ΜΑΥΡΟ ø56x400mm | 1/10 | PRICE (€)<br><b>46.60</b> |



PRODUCTION MATERIAL: **ALUMINIUM**  
ΥΛΙΚΟ ΚΑΤΑΣΚΕΥΗΣ: **ΑΛΟΥΜΙΝΙΟ**



|               |            |   |      |                           |
|---------------|------------|---|------|---------------------------|
| 5207227066276 | 145-25504  | HANGING CEILING LIGHT CYLINDER 1M BLACK/ GOLD ø65x250mm<br>ΦΩΤΙΣΤΙΚΟ ΚΡΕΜΑΣΤΟ ΚΥΛΙΝΔΡΟΣ 1M ΜΑΥΡΟ/ ΧΡΥΣΟ ø65x250mm | 1/20 | PRICE (€)<br><b>47.85</b> |
| 5207227066290 | 145-25505* | HANGING CEILING LIGHT CYLINDER 1M BLACK/ GOLD ø65x350mm<br>ΦΩΤΙΣΤΙΚΟ ΚΡΕΜΑΣΤΟ ΚΥΛΙΝΔΡΟΣ 1M ΜΑΥΡΟ/ ΧΡΥΣΟ ø65x350mm | 1/10 | PRICE (€)<br><b>56.20</b> |

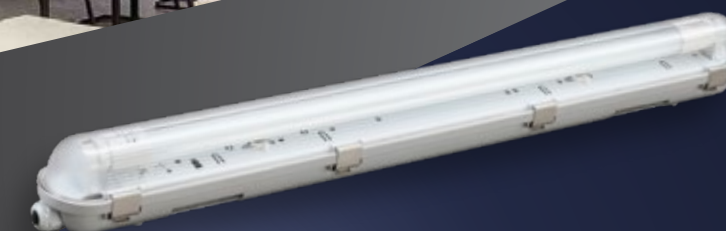

Φωτιστικά Φθορίου LED / Προβολείς / Καμπάνες / Φωτιστικά Δρόμου

Ceiling Fluorescent Lights / Projectors / High Bay Lights / Street Lights

για Επαγγελματική Χρήση

for Professional use

Ιδανικοί για χρήση σε χώρους όπως:

- Κατοικίες
- Καταστήματα
- Εμπορικά Κέντρα
- Αποθήκες
- Βιοτεχνικούς Χώρους
- Βιομηχανικούς Χώρους
- Μοτέλ
- Ξενοδοχεία
- Αίθουσες Διδασκαλίας
- Εκθεσιακούς Χώρους
- Μουσεία
- Αρχιτεκτονικές Δομές
- Δημόσιες Εγκαταστάσεις

Ideal for use in places as:

- Residences
- Stores
- Shopping Malls
- Warehouses
- Business Areas
- Industrial Areas
- Motels
- Hotels
- Teaching Rooms
- Exhibitions
- Museums
- Architectural Structures
- Public Facilities

LED TUBES • ΦΩΤΙΣΤΙΚΑ ΠΑΓΚΟΥ



PRODUCTION MATERIAL: **ABS & PLASTIC**  
 ΥΛΙΚΟ ΚΑΤΑΣΚΕΥΗΣ: **ABS & PLASTIC**  
 WITH MOTION SENSOR / ΜΕ ΑΝΙΧΝΕΥΤΗ ΚΙΝΗΣΗΣ

| BEAM ANGLE<br>H:120°<br>V:60° | DELAY TIME<br>20-30 Sec | SWITCH MODE<br>Auto / On / Off | CONTINUOUS OPERATION<br>6-8 Hrs | 10000<br>ON-OFF | 15000h<br>LIFE TIME | START TIME min:<br>0.5 sec | Double<br>Blister<br>PACKING |           |
|-------------------------------|-------------------------|--------------------------------|---------------------------------|-----------------|---------------------|----------------------------|------------------------------|-----------|
| BARCODE                       | CODE                    | WATT                           | KELVIN                          | TOTAL LUMEN     | DIMENSIONS          | COLOR                      | PACKING                      | PRICE (€) |
| 5206139080813                 | 145-55321               | 1,2W                           | 3000K                           | 80 lm           | 300x45x20mm         | WHITE                      | 1/40                         | 14.30     |



PRODUCTION MATERIAL: **IRON & PLASTIC**  
 ΥΛΙΚΟ ΚΑΤΑΣΚΕΥΗΣ: **ΣΙΔΗΡΟΣ & ΠΛΑΣΤΙΚΟ**  
 CLOSED TYPE WITH LED TAPES /  
 ΚΛΕΙΣΤΟΥ ΤΥΠΟΥ ΜΕ ΤΑΙΝΙΕΣ LED

| BEAM ANGLE<br>120° | PF<br>>0.5 | Ra<br>>70 | 25000<br>ON-OFF | 25000h<br>LIFE TIME | START TIME min:<br>1 sec | -5°C ~ +45°C<br>OPERATING TEMP. | GROUNDING | Color Box<br>PACKING |           |
|--------------------|------------|-----------|-----------------|---------------------|--------------------------|---------------------------------|-----------|----------------------|-----------|
| BARCODE            | CODE       | WATT      | KELVIN          | AMPERAGE            | DIMENSIONS               | WEIGHT                          | COLOR     | PACKING              | PRICE (€) |
| 5207227018688      | 147-55350  | 18W       | 6500K           | 250mA               | 600x61x24mm              | 0.400Kg                         | WHITE     | 1/30                 | 12.60     |
| 5207227018701      | 147-55352  | 36W       | 6500K           | 300mA               | 1200x61x24mm             | 0.400Kg                         | WHITE     | 1/30                 | 15.60     |



PRODUCTION MATERIAL: **PVC & GLASS**  
 ΥΛΙΚΟ ΚΑΤΑΣΚΕΥΗΣ: **PVC & ΓΥΑΛΙ**

| BEAM ANGLE<br>180° | PF<br>>0.5 | Ra<br>>80 | 15000<br>ON-OFF | 30000h<br>LIFE TIME | START TIME min:<br>3 sec | -20°C ~ +40°C<br>OPERATING TEMP. | Color Box<br>PACKING |         |           |
|--------------------|------------|-----------|-----------------|---------------------|--------------------------|----------------------------------|----------------------|---------|-----------|
| BARCODE            | CODE       | WATT      | KELVIN          | AMPERAGE            | DIMENSIONS               | WEIGHT                           | COLOR                | PACKING | PRICE (€) |
| 5206139041166      | 147-55380  | 5W        | 4000K           | 22mA                | 22x32x317mm              | 0,110 Kg                         | WHITE                | 1/25    | 9.90      |
| 5206139041180      | 147-55381  | 9W        | 4000K           | 40mA                | 22x32x554mm              | 0,180 Kg                         | WHITE                | 1/25    | 11.25     |
| 5206139041210      | 147-55382  | 14W       | 4000K           | 60mA                | 22x32x859mm              | 0,270 Kg                         | WHITE                | 1/25    | 14.85     |
| 5206139041234      | 147-55383  | 18W       | 4000K           | 78mA                | 22x32x117mm              | 0,350 Kg                         | WHITE                | 1/25    | 18.20     |
| 5207227008672      | 147-55384  | 5W        | 6500K           | 22mA                | 22x32x317mm              | 0,110 Kg                         | WHITE                | 1/25    | 9.90      |
| 5207227008702      | 147-55385  | 9W        | 6500K           | 40mA                | 22x32x554mm              | 0,180 Kg                         | WHITE                | 1/25    | 11.25     |
| 5207227008726      | 147-55386  | 14W       | 6500K           | 60mA                | 22x32x859mm              | 0,270 Kg                         | WHITE                | 1/25    | 14.85     |
| 5207227008740      | 147-55387  | 18W       | 6500K           | 78mA                | 22x32x117mm              | 0,350 Kg                         | WHITE                | 1/25    | 18.20     |

BATTEN LUMINAIRES EMPTY • ΦΩΤΙΣΤΙΚΑ ΜΕΤΑΛΛΙΚΑ ΚΕΝΑ



PRODUCTION MATERIAL: **IRON**  
 ΥΛΙΚΟ ΚΑΤΑΣΚΕΥΗΣ: **ΣΙΔΗΡΟΣ**  
 SLIM

|               |           |               |              |         |       |         |           |                                      |
|---------------|-----------|---------------|--------------|---------|-------|---------|-----------|--------------------------------------|
|               |           |               |              |         |       |         |           |                                      |
|               |           |               |              |         |       |         |           |                                      |
| BARCODE       | CODE      | WATT          | DIMENSIONS   | WEIGHT  | COLOR | PACKING | PRICE (€) | Nylon Bag<br>with Sticker<br>PACKING |
| 5207227018725 | 147-56550 | max 9W LED    | 35x18x600mm  | 0.134kg | WHITE | 1/50    | 2.54      |                                      |
| 5207227018749 | 147-56551 | max 18W LED   | 32x16x1200mm | 0.240kg | WHITE | 1/50    | 2.89      |                                      |
| 5207227018763 | 147-56553 | max 2x9W LED  | 40x20x600mm  | 0.205kg | WHITE | 1/32    | 5.58      |                                      |
| 5207227018787 | 147-56554 | max 2x18W LED | 45x25x1200mm | 0.354kg | WHITE | 1/32    | 5.90      |                                      |
| 5207227031595 | 147-56556 | max 24W LED   | 30x45x1500mm | 0.273kg | WHITE | 1/50    | 5.45      |                                      |
| 5207227031625 | 147-56557 | max 2x24W LED | 75x48x1500mm | 0.300kg | WHITE | 1/32    | 7.55      |                                      |



PRODUCTION MATERIAL: **ABS**  
 ΥΛΙΚΟ ΚΑΤΑΣΚΕΥΗΣ: **ABS**

|               |           |               |              |         |       |         |           |                                      |
|---------------|-----------|---------------|--------------|---------|-------|---------|-----------|--------------------------------------|
|               |           |               |              |         |       |         |           |                                      |
|               |           |               |              |         |       |         |           |                                      |
| BARCODE       | CODE      | WATT          | DIMENSIONS   | WEIGHT  | COLOR | PACKING | PRICE (€) | White Box<br>with Sticker<br>PACKING |
| 5206139042521 | 147-56070 | max 9W LED    | 60x40x615mm  | 0.900kg | GREY  | 1/12    | 9.55      |                                      |
| 5206139042545 | 147-56071 | max 18W LED   | 60x40x1230mm | 1.300kg | GREY  | 1/8     | 12.60     |                                      |
| 5206139044471 | 147-56072 | max 24W LED   | 60x40x1525mm | 0.950kg | GREY  | 1/12    | 18.95     |                                      |
| 5206139042552 | 147-56073 | max 2x9W LED  | 60x40x615mm  | 1.700kg | GREY  | 1/8     | 11.85     |                                      |
| 5206139042583 | 147-56074 | max 2x18W LED | 60x40x1230mm | 1.950kg | GREY  | 1/6     | 14.55     |                                      |
| 5206139044488 | 147-56075 | max 2x24W LED | 60x40x1525mm | 2.250kg | GREY  | 1/6     | 22.45     |                                      |

BATTEN LUMINAIRES EMPTY • ΦΩΤΙΣΤΙΚΑ ΜΕΤΑΛΛΙΚΑ ΚΕΝΑ

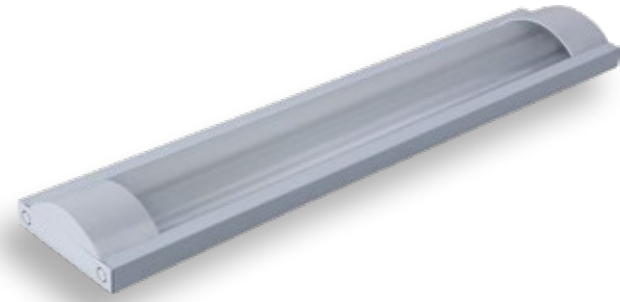

PRODUCTION MATERIAL: **IRON & PLASTIC**  
ΥΛΙΚΟ ΚΑΤΑΣΚΕΥΗΣ: **ΣΙΔΗΡΟΣ & ΠΛΑΣΤΙΚΟ**

EMPTY FOR LED TUBE OVAL/  
ΚΕΝΟ ΟΒΑΛ ΓΙΑ LED TUBE

| BARCODE       | CODE      | WATT      | DIMENSIONS    | WEIGHT   | COLOR | PACKING | PRICE (€) |  |
|---------------|-----------|-----------|---------------|----------|-------|---------|-----------|--|
| 5207227004124 | 147-56020 | max 2x9W  | 600x130x45mm  | 0.500 kg | WHITE | 1/12    | 17.95     |  |
| 5207227004148 | 147-56021 | max 2x18W | 1200x125x42mm | 0.907 kg | WHITE | 1/10    | 18.15     |  |

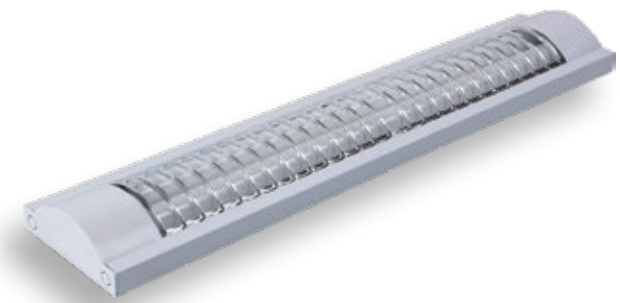

PRODUCTION MATERIAL: **IRON & PLASTIC**  
ΥΛΙΚΟ ΚΑΤΑΣΚΕΥΗΣ: **ΣΙΔΗΡΟΣ & ΠΛΑΣΤΙΚΟ**

EMPTY FOR LED TUBE OVAL WITH GRILLES/  
ΚΕΝΟ ΟΒΑΛ ΜΕ ΓΡΙΛΛΙΕΣ ΓΙΑ LED TUBE

| BARCODE       | CODE      | WATT      | DIMENSIONS    | WEIGHT   | COLOR | PACKING | PRICE (€) |  |
|---------------|-----------|-----------|---------------|----------|-------|---------|-----------|--|
| 5207227004162 | 147-56022 | max 2x9W  | 600x130x48mm  | 0.513 kg | WHITE | 1/12    | 16.85     |  |
| 5207227004186 | 147-56023 | max 2x18W | 1200x125x42mm | 0.911 kg | WHITE | 1/10    | 18.90     |  |



PRODUCTION MATERIAL: **METALLIC**  
ΥΛΙΚΟ ΚΑΤΑΣΚΕΥΗΣ: **ΜΕΤΑΛΛΟ**  
SURFACE WALL MOUNTED  
ΕΞΩΤΕΡΙΚΟ ΔΙΠΛΗΣ ΠΑΡΑΒΟΛΙΚΟΤΗΤΑΣ

| BARCODE       | CODE      | WATT      | DIMENSIONS    | WEIGHT  | COLOR | PACKING | PRICE (€) |  |
|---------------|-----------|-----------|---------------|---------|-------|---------|-----------|--|
| 5206139072764 | 147-56160 | max 2x18W | 365x70x1240mm | 3.500kg | WHITE | 1/2     | 49.60     |  |
| 5207227073847 | 147-56161 | max 4x9W  | 640x70x640mm  | 2.800kg | WHITE | 1/2     | 49.60     |  |

BATTEN LUMINAIRES EMPTY • ΦΩΤΙΣΤΙΚΑ ΜΕΤΑΛΛΙΚΑ ΚΕΝΑ



PRODUCTION MATERIAL: **METALLIC**  
ΥΛΙΚΟ ΚΑΤΑΣΚΕΥΗΣ: **ΜΕΤΑΛΛΟ**  
WITH MAGNETIC BALLAST /  
ΜΕ ΜΑΓΝΗΤΙΚΟ ΜΠΑΛΑΣΤ

| BARCODE       | CODE      | WATT  | DIMENSIONS   | WEIGHT  | COLOR | PACKING | PRICE (€) |  |
|---------------|-----------|-------|--------------|---------|-------|---------|-----------|--|
| 5206139400000 | 147-56000 | 1x18W | 60x40x615mm  | 0.900kg | WHITE | 1/12    | 16.85     |  |
| 5206139400017 | 147-56001 | 1x36W | 60x40x1230mm | 1.300kg | WHITE | 1/8     | 18.65     |  |
| 5206139400024 | 147-56002 | 2x18W | 60x40x615mm  | 0.950kg | WHITE | 1/12    | 19.20     |  |
| 5206139400031 | 147-56003 | 2x36W | 60x40x1230mm | 1.700kg | WHITE | 1/8     | 28.25     |  |
| 5206139400048 | 147-56004 | 1x58W | 60x40x1525mm | 1.950kg | WHITE | 1/6     | 31.75     |  |
| 5206139400055 | 147-56005 | 2x58W | 60x40x1525mm | 2.250kg | WHITE | 1/6     | 43.55     |  |



PRODUCTION MATERIAL: **METALLIC**  
ΥΛΙΚΟ ΚΑΤΑΣΚΕΥΗΣ: **ΜΕΤΑΛΛΟ**  
WITH MECHANICAL BALLAST /  
ΜΕ ΜΗΧΑΝΙΚΟ ΜΠΑΛΑΣΤ

| BARCODE       | CODE      | WATT  | AMPERAGE | DIMENSIONS | WEIGHT  | COLOR | PACKING | PRICE (€) |
|---------------|-----------|-------|----------|------------|---------|-------|---------|-----------|
| 5207227073816 | 147-56050 | 1x32W | 430mA    | ø340x35mm  | 0.982kg | WHITE | 1/2     | 22.65     |
| 5206139470515 | 147-56051 | 1x40W | 430mA    | ø340x35mm  | 0.982kg | WHITE | 1/2     | 22.65     |
| 5206139470522 | 147-56052 | 1x72W | 860mA    | ø340x35mm  | 1.450kg | WHITE | 1/2     | 34.60     |

LINEAR LIGHT FIXTURES • ΦΩΤΙΣΤΙΚΑ ΓΡΑΜΜΙΚΑ LED

**NEW!**



PRODUCTION MATERIAL: **PLASTIC**  
ΥΛΙΚΟ ΚΑΤΑΣΚΕΥΗΣ: ΠΛΑΣΤΙΚΟ

VALUE



| BARCODE       | CODE      | WATT | AMPERAGE | KELVIN | DIMENSIONS   | WEIGHT  | COLOR                  | PACKING | PRICE (€) |
|---------------|-----------|------|----------|--------|--------------|---------|------------------------|---------|-----------|
| 5207227068249 | 147-56610 | 18W  | 80mA     | 6500K  | 58x37x640mm  | 0.150kg | WHITE BASE/MILKY COVER | 1/24    | 19.90     |
| 5207227068263 | 147-56611 | 18W  | 80mA     | 4000K  | 58x37x640mm  | 0.150kg | WHITE BASE/MILKY COVER | 1/24    | 19.90     |
| 5207227071850 | 147-56612 | 18W  | 80mA     | 3000K  | 58x37x640mm  | 0.150kg | WHITE BASE/MILKY COVER | 1/24    | 19.90     |
| 5207227068287 | 147-56613 | 36W  | 162mA    | 6500K  | 58x37x1260mm | 0.300kg | WHITE BASE/MILKY COVER | 1/24    | 29.35     |
| 5207227068300 | 147-56614 | 36W  | 162mA    | 4000K  | 58x37x1260mm | 0.300kg | WHITE BASE/MILKY COVER | 1/24    | 29.35     |
| 5207227071867 | 147-56615 | 36W  | 162mA    | 3000K  | 58x37x1260mm | 0.300kg | WHITE BASE/MILKY COVER | 1/24    | 29.35     |
| 5207227068324 | 147-56616 | 45W  | 205mA    | 6500K  | 58x37x1540mm | 0.400kg | WHITE BASE/MILKY COVER | 1/24    | 36.20     |
| 5207227068348 | 147-56617 | 45W  | 205mA    | 4000K  | 58x37x1540mm | 0.400kg | WHITE BASE/MILKY COVER | 1/24    | 36.20     |
| 5207227071874 | 147-56618 | 45W  | 205mA    | 3000K  | 58x37x1540mm | 0.400kg | WHITE BASE/MILKY COVER | 1/24    | 36.20     |

**NEW!**



PRODUCTION MATERIAL: **NANO PC**  
ΥΛΙΚΟ ΚΑΤΑΣΚΕΥΗΣ: ΝΑΝΟ PC

**NANO PC**

LINEAR LED SLIM / ΓΡΑΜΜΙΚΟ LED SLIM

PRO



| BARCODE       | CODE      | WATT | AMPERAGE | KELVIN | DIMENSIONS   | WEIGHT  | COLOR | PACKING | PRICE (€) |
|---------------|-----------|------|----------|--------|--------------|---------|-------|---------|-----------|
| 5207227068362 | 147-56620 | 18W  | 80mA     | 6500K  | 43x33x625mm  | 0.230kg | MILKY | 1/24    | 19.45     |
| 5207227068386 | 147-56621 | 18W  | 80mA     | 4000K  | 43x33x625mm  | 0.230kg | MILKY | 1/24    | 19.45     |
| 5207227071881 | 147-56622 | 18W  | 80mA     | 3000K  | 43x33x625mm  | 0.230kg | MILKY | 1/24    | 19.45     |
| 5207227068409 | 147-56623 | 24W  | 109mA    | 6500K  | 43x33x1225mm | 0.350kg | MILKY | 1/24    | 27.75     |
| 5207227068423 | 147-56624 | 24W  | 109mA    | 4000K  | 43x33x1225mm | 0.350kg | MILKY | 1/24    | 27.75     |
| 5207227071898 | 147-56625 | 24W  | 109mA    | 3000K  | 43x33x1225mm | 0.350kg | MILKY | 1/24    | 27.75     |
| 5207227068447 | 147-56626 | 36W  | 162mA    | 6500K  | 43x33x1525mm | 0.430kg | MILKY | 1/24    | 35.80     |
| 5207227068461 | 147-56627 | 36W  | 162mA    | 4000K  | 43x33x1525mm | 0.430kg | MILKY | 1/24    | 35.80     |
| 5207227071904 | 147-56628 | 36W  | 162mA    | 3000K  | 43x33x1525mm | 0.430kg | MILKY | 1/24    | 35.80     |

BATTEN LUMINAIRES EMPTY • ΦΩΤΙΣΤΙΚΑ ΚΕΝΑ ΓΙΑ LED TUBES



PRODUCTION MATERIAL: **PLASTIC**  
ΥΛΙΚΟ ΚΑΤΑΣΚΕΥΗΣ: ΠΛΑΣΤΙΚΟ  
WITH INOX CLIPS/  
ME INOX CLIPS



| BARCODE       | CODE      | WATT          | DIMENSIONS    | WEIGHT  | COLOR | PACKING | PRICE (€) |
|---------------|-----------|---------------|---------------|---------|-------|---------|-----------|
| 5206139084279 | 147-56060 | max 9W LED    | 68x74x670mm   | 0.670kg | WHITE | 1/6     | 14.65     |
| 5206139084293 | 147-56061 | max 18W LED   | 68x74x1270mm  | 1.200kg | WHITE | 1/6     | 21.85     |
| 5206139084309 | 147-56062 | max 24W LED   | 68x74x1570mm  | 1.500kg | WHITE | 1/6     | 28.35     |
| 5206139084316 | 147-56063 | max 2x9W LED  | 104x74x670mm  | 0.950kg | WHITE | 1/6     | 17.90     |
| 5206139084323 | 147-56064 | max 2x18W LED | 104x74x1270mm | 1.520kg | WHITE | 1/6     | 27.65     |
| 5206139078131 | 147-56065 | max 2x24W LED | 104x74x1570mm | 1.900kg | WHITE | 1/6     | 33.45     |

**NEW!**



PRODUCTION MATERIAL: **PLASTIC**  
ΥΛΙΚΟ ΚΑΤΑΣΚΕΥΗΣ: ΠΛΑΣΤΙΚΟ  
LINEAR WATERPROOF / ΓΡΑΜΜΙΚΟ ΣΤΕΓΑΝΟ

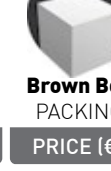

| BARCODE       | CODE       | WATT | AMPERAGE | KELVIN | DIMENSIONS   | WEIGHT  | COLOR                 | PACKING | PRICE (€) |
|---------------|------------|------|----------|--------|--------------|---------|-----------------------|---------|-----------|
| 5207227059568 | 147-56600  | 24W  | 165mA    | 4000K  | 92x60x600mm  | 0.800kg | GREY BASE/MILKY COVER | 1/15    | 32.85     |
| 5207227069864 | 147-56601  | 24W  | 165mA    | 5700K  | 92x60x600mm  | 0.800kg | GREY BASE/MILKY COVER | 1/15    | 32.85     |
| 5207227059582 | 147-56603  | 48W  | 216mA    | 4000K  | 92x60x1200mm | 1.500kg | GREY BASE/MILKY COVER | 1/8     | 65.60     |
| 5207227069871 | 147-56604  | 48W  | 216mA    | 5700K  | 92x60x1200mm | 1.500kg | GREY BASE/MILKY COVER | 1/8     | 65.60     |
| 5207227059605 | 147-56606* | 56W  | 243mA    | 4000K  | 92x60x1500mm | 1.800kg | GREY BASE/MILKY COVER | 1/8     | 77.65     |
| 5207227069888 | 147-56607* | 56W  | 243mA    | 5700K  | 92x60x1500mm | 1.800kg | GREY BASE/MILKY COVER | 1/8     | 77.65     |

PROJECTOR LED SMD • ΠΡΟΒΟΛΕΙΣ LED SMD



PRODUCTION MATERIAL: ALUMINIUM & GLASS  
ΥΛΙΚΟ ΚΑΤΑΣΚΕΥΗΣ: ΑΛΟΥΜΙΝΙΟ & ΓΥΑΛΙ



150W

IP65 ENERGY CLASS A+ LUMENS 85/W INSTALLATION HEIGHT 2M SMD 2835 CLASS II 0,190Kg GROUNDING

VOLT 220-240V 50-60Hz BEAM ANGLE 100° PF >0.8 Ra >70 IK 06 25000 ON-OFF 30000h LIFE TIME START TIME min: 0.5 sec -40°C ~ +50°C OPERATING TEMP.

| BARCODE       | CODE      | WATT | KELVIN | AMPERAGE | COLOR | PACKING | PRICE (€) |
|---------------|-----------|------|--------|----------|-------|---------|-----------|
| 5207227011870 | 147-69400 | 10W  | 6500K  | 50mA     | WHITE | 1/40    | 7.65      |
| 5207227011894 | 147-69401 | 10W  | 4000K  | 50mA     | WHITE | 1/40    | 7.65      |
| 5207227011917 | 147-69402 | 10W  | 3000K  | 50mA     | WHITE | 1/40    | 7.65      |
| 5207227011924 | 147-69403 | 10W  | 6500K  | 50mA     | BLACK | 1/40    | 7.65      |
| 5207227011948 | 147-69404 | 10W  | 4000K  | 50mA     | BLACK | 1/40    | 7.65      |
| 5207227011962 | 147-69405 | 10W  | 3000K  | 50mA     | BLACK | 1/40    | 7.65      |

IP65 ENERGY CLASS A+ LUMENS 95/W INSTALLATION HEIGHT 3M SMD 2835 CLASS II 0,280Kg GROUNDING

VOLT 220-240V 50-60Hz BEAM ANGLE 100° PF >0.8 Ra >70 IK 06 25000 ON-OFF 30000h LIFE TIME START TIME min: 0.5 sec -40°C ~ +50°C OPERATING TEMP.

| BARCODE       | CODE      | WATT | KELVIN | AMPERAGE | COLOR | PACKING | PRICE (€) |
|---------------|-----------|------|--------|----------|-------|---------|-----------|
| 5207227011986 | 147-69410 | 20W  | 6500K  | 100mA    | WHITE | 1/20    | 13.75     |
| 5207227012006 | 147-69411 | 20W  | 4000K  | 100mA    | WHITE | 1/20    | 13.75     |
| 5207227012020 | 147-69412 | 20W  | 3000K  | 100mA    | WHITE | 1/20    | 13.75     |
| 5207227012044 | 147-69413 | 20W  | 6500K  | 100mA    | BLACK | 1/20    | 13.75     |
| 5207227012068 | 147-69414 | 20W  | 4000K  | 100mA    | BLACK | 1/20    | 13.75     |
| 5207227012082 | 147-69415 | 20W  | 3000K  | 100mA    | BLACK | 1/20    | 13.75     |

IP65 ENERGY CLASS A+ LUMENS 95/W INSTALLATION HEIGHT 4M SMD 2835 CLASS II 0,410 Kg GROUNDING

VOLT 220-240V 50-60Hz BEAM ANGLE 100° PF >0.9 Ra >70 IK 06 25000 ON-OFF 30000h LIFE TIME START TIME min: 0.5 sec -40°C ~ +50°C OPERATING TEMP.

| BARCODE       | CODE      | WATT | KELVIN | AMPERAGE | COLOR | PACKING | PRICE (€) |
|---------------|-----------|------|--------|----------|-------|---------|-----------|
| 5207227012105 | 147-69420 | 30W  | 6500K  | 150mA    | WHITE | 1/20    | 18.95     |
| 5207227012129 | 147-69421 | 30W  | 4000K  | 150mA    | WHITE | 1/20    | 18.95     |
| 5207227012143 | 147-69422 | 30W  | 3000K  | 150mA    | WHITE | 1/20    | 18.95     |
| 5207227012167 | 147-69423 | 30W  | 6500K  | 150mA    | BLACK | 1/20    | 18.95     |
| 5207227012181 | 147-69424 | 30W  | 4000K  | 150mA    | BLACK | 1/20    | 18.95     |
| 5207227012204 | 147-69425 | 30W  | 3000K  | 150mA    | BLACK | 1/20    | 18.95     |

PROJECTOR LED SMD • ΠΡΟΒΟΛΕΙΣ LED SMD

160x35x216mm

PRODUCTION MATERIAL: ALUMINIUM & GLASS  
ΥΛΙΚΟ ΚΑΤΑΣΚΕΥΗΣ: ΑΛΟΥΜΙΝΙΟ & ΓΥΑΛΙ



IP65 ENERGY CLASS A+ LUMENS 95/W INSTALLATION HEIGHT 5M SMD 2835 CLASS II GROUNDING -40°C ~ +50°C OPERATING TEMP.

VOLT 220-240V 50-60Hz BEAM ANGLE 100° PF >0.9 Ra >70 IK 06 25000 ON-OFF 30000h LIFE TIME START TIME min: 0.5 sec

| BARCODE       | CODE      | WATT | KELVIN | AMPERAGE | WEIGHT   | COLOR | PACKING | PRICE (€) |
|---------------|-----------|------|--------|----------|----------|-------|---------|-----------|
| 5207227012228 | 147-69430 | 50W  | 6500K  | 250mA    | 0.640 kg | WHITE | 1/10    | 27.65     |
| 5207227012242 | 147-69431 | 50W  | 4000K  | 250mA    | 0.640 kg | WHITE | 1/10    | 27.65     |
| 5207227012266 | 147-69432 | 50W  | 3000K  | 250mA    | 0.640 kg | WHITE | 1/10    | 27.65     |
| 5207227012280 | 147-69433 | 50W  | 6500K  | 250mA    | 0.640 kg | BLACK | 1/10    | 27.65     |
| 5207227012303 | 147-69434 | 50W  | 4000K  | 250mA    | 0.640 kg | BLACK | 1/10    | 27.65     |
| 5207227012327 | 147-69435 | 50W  | 3000K  | 250mA    | 0.640 kg | BLACK | 1/10    | 27.65     |

230x40x310mm

PRODUCTION MATERIAL: ALUMINIUM & GLASS  
ΥΛΙΚΟ ΚΑΤΑΣΚΕΥΗΣ: ΑΛΟΥΜΙΝΙΟ & ΓΥΑΛΙ



IP65 ENERGY CLASS A+ LUMENS 95/W INSTALLATION HEIGHT 7M SMD 2835 CLASS II GROUNDING -40°C ~ +50°C OPERATING TEMP.

VOLT 220-240V 50-60Hz BEAM ANGLE 100° PF >0.9 Ra >70 IK 06 25000 ON-OFF 30000h LIFE TIME START TIME min: 0.5 sec

| BARCODE       | CODE      | WATT | KELVIN | AMPERAGE | WEIGHT  | COLOR | PACKING | PRICE (€) |
|---------------|-----------|------|--------|----------|---------|-------|---------|-----------|
| 5207227012488 | 147-69460 | 100W | 6500K  | 500mA    | 1,500kg | BLACK | 1/5     | 62.35     |
| 5207227012501 | 147-69461 | 100W | 4000K  | 500mA    | 1,500kg | BLACK | 1/5     | 62.35     |
| 5207227012525 | 147-69470 | 150W | 6500K  | 750mA    | 2,900kg | BLACK | 1/5     | 98.65     |
| 5207227012549 | 147-69471 | 150W | 4000K  | 750mA    | 2,900kg | BLACK | 1/5     | 98.65     |



420x50x360mm  
530x55x440mm\*



IP65 ENERGY CLASS A+ LUMENS 105/W INSTALLATION HEIGHT 20M SMD 5730 2835 CLASS II GROUNDING -40°C ~ +50°C OPERATING TEMP.

VOLT 100-240V 50-60Hz BEAM ANGLE 100° PF >0.9 Ra >70 IK 07 25000 ON-OFF 30000h LIFE TIME START TIME min: 0.5 sec

| BARCODE       | CODE       | WATT | KELVIN | AMPERAGE | WEIGHT   | COLOR | PACKING | PRICE (€) |
|---------------|------------|------|--------|----------|----------|-------|---------|-----------|
| 5207227029684 | 147-69480  | 200W | 6500K  | 1A       | 6,150kg  | BLACK | 1/1     | 226.00    |
| 5207227029936 | 147-69481  | 200W | 4000K  | 1A       | 6,150kg  | BLACK | 1/1     | 226.00    |
| 5207227029943 | 147-69483* | 300W | 6500K  | 1.5A     | 10,000kg | BLACK | 1/1     | 348.00    |
| 5207227029950 | 147-69484* | 300W | 4000K  | 1.5A     | 10,000kg | BLACK | 1/1     | 348.00    |



PROJECTOR LED SMD BASE 360°  
• ΠΡΟΒΟΛΕΙΣ LED SMD ΒΑΣΗ 360°

PRODUCTION MATERIAL: ALUMINIUM & GLASS  
ΥΛΙΚΟ ΚΑΤΑΣΚΕΥΗΣ: ΑΛΟΥΜΙΝΙΟ & ΓΥΑΛΙ



150W

113x22x127mm

Color Box PACKING

| BARCODE       | CODE      | WATT | KELVIN | AMPERAGE | COLOR | PACKING | PRICE (€) |
|---------------|-----------|------|--------|----------|-------|---------|-----------|
| 5207227061752 | 147-69310 | 10W  | 6500K  | 50mA     | WHITE | 1/60    | 7.95      |
| 5207227061776 | 147-69311 | 10W  | 4000K  | 50mA     | WHITE | 1/60    | 7.95      |
| 5207227061790 | 147-69312 | 10W  | 3000K  | 50mA     | WHITE | 1/60    | 7.95      |
| 5207227061813 | 147-69313 | 10W  | 6500K  | 50mA     | BLACK | 1/60    | 7.95      |
| 5207227061837 | 147-69314 | 10W  | 4000K  | 50mA     | BLACK | 1/60    | 7.95      |
| 5207227061851 | 147-69315 | 10W  | 3000K  | 50mA     | BLACK | 1/60    | 7.95      |

136x24x162mm

Color Box PACKING

| BARCODE       | CODE      | WATT | KELVIN | AMPERAGE | COLOR | PACKING | PRICE (€) |
|---------------|-----------|------|--------|----------|-------|---------|-----------|
| 5207227061875 | 147-69316 | 20W  | 6500K  | 100mA    | WHITE | 1/40    | 14.25     |
| 5207227061899 | 147-69317 | 20W  | 4000K  | 100mA    | WHITE | 1/40    | 14.25     |
| 5207227061912 | 147-69318 | 20W  | 3000K  | 100mA    | WHITE | 1/40    | 14.25     |
| 5207227061936 | 147-69319 | 20W  | 6500K  | 100mA    | BLACK | 1/40    | 14.25     |
| 5207227061950 | 147-69320 | 20W  | 4000K  | 100mA    | BLACK | 1/40    | 14.25     |
| 5207227061974 | 147-69321 | 20W  | 3000K  | 100mA    | BLACK | 1/40    | 14.25     |

157x25x192mm

Color Box PACKING

| BARCODE       | CODE      | WATT | KELVIN | AMPERAGE | COLOR | PACKING | PRICE (€) |
|---------------|-----------|------|--------|----------|-------|---------|-----------|
| 5207227061998 | 147-69322 | 30W  | 6500K  | 150mA    | WHITE | 1/20    | 19.65     |
| 5207227062018 | 147-69323 | 30W  | 4000K  | 150mA    | WHITE | 1/20    | 19.65     |
| 5207227062032 | 147-69324 | 30W  | 3000K  | 150mA    | WHITE | 1/20    | 19.65     |
| 5207227062056 | 147-69325 | 30W  | 6500K  | 150mA    | BLACK | 1/20    | 19.65     |
| 5207227062070 | 147-69326 | 30W  | 4000K  | 150mA    | BLACK | 1/20    | 19.65     |
| 5207227062094 | 147-69327 | 30W  | 3000K  | 150mA    | BLACK | 1/20    | 19.65     |

PROJECTOR LED SMD BASE 360° • ΠΡΟΒΟΛΕΙΣ LED SMD ΒΑΣΗ 360°

PRODUCTION MATERIAL: ALUMINIUM & GLASS  
ΥΛΙΚΟ ΚΑΤΑΣΚΕΥΗΣ: ΑΛΟΥΜΙΝΙΟ & ΓΥΑΛΙ



185x26x227mm

Color Box PACKING

| BARCODE       | CODE      | WATT | KELVIN | AMPERAGE | COLOR | PACKING | PRICE (€) |
|---------------|-----------|------|--------|----------|-------|---------|-----------|
| 5207227062117 | 147-69328 | 50W  | 6500K  | 250mA    | WHITE | 1/20    | 28.15     |
| 5207227062131 | 147-69329 | 50W  | 4000K  | 250mA    | WHITE | 1/20    | 28.15     |
| 5207227062155 | 147-69330 | 50W  | 3000K  | 250mA    | WHITE | 1/20    | 28.15     |
| 5207227062179 | 147-69331 | 50W  | 6500K  | 250mA    | BLACK | 1/20    | 28.15     |
| 5207227062193 | 147-69332 | 50W  | 4000K  | 250mA    | BLACK | 1/20    | 28.15     |
| 5207227062216 | 147-69333 | 50W  | 3000K  | 250mA    | BLACK | 1/20    | 28.15     |

245x33x316mm

Color Box PACKING

| BARCODE       | CODE      | WATT | KELVIN | AMPERAGE | COLOR | PACKING | PRICE (€) |
|---------------|-----------|------|--------|----------|-------|---------|-----------|
| 5207227062230 | 147-69350 | 100W | 6500K  | 500mA    | BLACK | 1/10    | 63.75     |
| 5207227062254 | 147-69351 | 100W | 4000K  | 500mA    | BLACK | 1/10    | 63.75     |
| 5207227062278 | 147-69352 | 100W | 3000K  | 500mA    | BLACK | 1/10    | 63.75     |

308x33x396mm

Color Box PACKING

| BARCODE       | CODE      | WATT | KELVIN | AMPERAGE | COLOR | PACKING | PRICE (€) |
|---------------|-----------|------|--------|----------|-------|---------|-----------|
| 5207227062292 | 147-69353 | 150W | 6500K  | 750mA    | BLACK | 1/4     | 98.90     |
| 5207227062315 | 147-69354 | 150W | 4000K  | 750mA    | BLACK | 1/4     | 98.90     |
| 5207227062339 | 147-69355 | 150W | 3000K  | 750mA    | BLACK | 1/4     | 98.90     |



PROJECTOR LED SMD WITH ROTATED MOVEMENT DETECTOR • ΠΡΟΒΟΛΕΙΣ LED SMD ΜΕ ΠΕΡΙΣΤΡΕΦΟΜΕΝΟ ΑΝΙΧΝΕΥΤΗ ΚΙΝΗΣΗΣ

PRODUCTION MATERIAL: ALUMINIUM & PC  
ΥΛΙΚΟ ΚΑΤΑΣΚΕΥΗΣ: ΑΛΟΥΜΙΝΙΟ & PC



**NEW!**

160x50x115mm

| BARCODE       | CODE      | WATT | KELVIN | AMPERAGE | LUMEN/W     | COLOR | PACKING | PRICE (€) |
|---------------|-----------|------|--------|----------|-------------|-------|---------|-----------|
| 5207227058325 | 147-69630 | 10W  | 6500K  | 50mA     | 105 lm/watt | BLACK | 1/40    | 25.95     |
| 5207227058349 | 147-69631 | 10W  | 4000K  | 50mA     | 105 lm/watt | BLACK | 1/40    | 25.95     |
| 5207227058363 | 147-69632 | 10W  | 3000K  | 50mA     | 95 lm/watt  | BLACK | 1/40    | 25.95     |

180x50x137mm

| BARCODE       | CODE      | WATT | KELVIN | AMPERAGE | LUMEN/W     | COLOR | PACKING | PRICE (€) |
|---------------|-----------|------|--------|----------|-------------|-------|---------|-----------|
| 5207227058387 | 147-69633 | 20W  | 6500K  | 100mA    | 105 lm/watt | BLACK | 1/20    | 33.15     |
| 5207227058400 | 147-69634 | 20W  | 4000K  | 100mA    | 105 lm/watt | BLACK | 1/20    | 33.15     |
| 5207227058424 | 147-69635 | 20W  | 3000K  | 100mA    | 95 lm/watt  | BLACK | 1/20    | 33.15     |

215x50x180mm

| BARCODE       | CODE      | WATT | KELVIN | AMPERAGE | LUMEN/W     | COLOR | PACKING | PRICE (€) |
|---------------|-----------|------|--------|----------|-------------|-------|---------|-----------|
| 5207227058448 | 147-69636 | 30W  | 6500K  | 150mA    | 105 lm/watt | BLACK | 1/20    | 39.85     |
| 5207227058462 | 147-69637 | 30W  | 4000K  | 150mA    | 105 lm/watt | BLACK | 1/20    | 39.85     |
| 5207227058486 | 147-69638 | 30W  | 3000K  | 150mA    | 95 lm/watt  | BLACK | 1/20    | 39.85     |

250x50x227mm

| BARCODE       | CODE      | WATT | KELVIN | AMPERAGE | LUMEN/W     | COLOR | PACKING | PRICE (€) |
|---------------|-----------|------|--------|----------|-------------|-------|---------|-----------|
| 5207227058509 | 147-69642 | 50W  | 6500K  | 250mA    | 105 lm/watt | BLACK | 1/10    | 52.65     |
| 5207227058523 | 147-69643 | 50W  | 4000K  | 250mA    | 105 lm/watt | BLACK | 1/10    | 52.65     |
| 5207227058547 | 147-69644 | 50W  | 3000K  | 250mA    | 95 lm/watt  | BLACK | 1/10    | 52.65     |

PROJECTOR LED SMD WITH MOVEMENT DETECTOR • ΠΡΟΒΟΛΕΙΣ LED SMD ΜΕ ΑΝΙΧΝΕΥΤΗ ΚΙΝΗΣΗΣ

PRODUCTION MATERIAL: ALUMINIUM & PC  
ΥΛΙΚΟ ΚΑΤΑΣΚΕΥΗΣ: ΑΛΟΥΜΙΝΙΟ & PC



160x50x115mm

| BARCODE       | CODE      | WATT | AMPERAGE | DIMENSIONS   | WEIGHT  | COLOR | PACKING | PRICE (€) |
|---------------|-----------|------|----------|--------------|---------|-------|---------|-----------|
| 5207227012341 | 147-69451 | 10W  | 50mA     | 115x135x35mm | 0,317kg | BLACK | 1/40    | 25.60     |
| 5207227012365 | 147-69452 | 20W  | 100mA    | 150x168x35mm | 0,410kg | WHITE | 1/20    | 31.60     |
| 5207227012389 | 147-69453 | 20W  | 100mA    | 150x168x35mm | 0,410kg | BLACK | 1/20    | 31.60     |
| 5207227012402 | 147-69454 | 30W  | 150mA    | 180x180x35mm | 0,550kg | WHITE | 1/20    | 36.70     |
| 5207227012426 | 147-69455 | 30W  | 150mA    | 180x180x35mm | 0,550kg | BLACK | 1/20    | 36.70     |
| 5207227012440 | 147-69456 | 50W  | 250mA    | 206x216x40mm | 0,630kg | WHITE | 1/10    | 49.40     |
| 5207227012464 | 147-69457 | 50W  | 250mA    | 206x216x40mm | 0,630kg | BLACK | 1/10    | 49.40     |

160x50x115mm

| BARCODE       | CODE      | WATT | AMPERAGE | DIMENSIONS   | WEIGHT  | COLOR | PACKING | PRICE (€) |
|---------------|-----------|------|----------|--------------|---------|-------|---------|-----------|
| 5207227033728 | 147-69604 | 10W  | 50mA     | 115x135x35mm | 0,317kg | BLACK | 1/40    | 25.60     |
| 5207227033780 | 147-69613 | 30W  | 150mA    | 180x180x35mm | 0,550kg | WHITE | 1/20    | 36.70     |
| 5207227033803 | 147-69616 | 30W  | 150mA    | 180x180x35mm | 0,550kg | BLACK | 1/20    | 36.70     |
| 5207227033841 | 147-69622 | 50W  | 250mA    | 206x216x40mm | 0,630kg | BLACK | 1/10    | 49.40     |

PROJECTOR LED SMD WITH SENSOR DAY/NIGHT • ΠΡΟΒΟΛΕΙΣ LED SMD ΜΕ SENSOR ΗΜΕΡΑΣ/ΝΥΧΤΑΣ



PRODUCTION MATERIAL: **ALUMINIUM & GLASS**  
ΥΛΙΚΟ ΚΑΤΑΣΚΕΥΗΣ: **ΑΛΟΥΜΙΝΙΟ & ΓΥΑΛΙ**

Lights up automatically when the room light is below 30 LUX /  
Ανάβει αυτόματα όταν το φως του περιβάλλοντα χώρου είναι κάτω από 30 LUX

Switches off automatically when room light is over 50 LUX /  
Σβήνει αυτόματα όταν το φως του περιβάλλοντα χώρου είναι πάνω από 50 LUX

| BARCODE       | CODE      | WATT | AMPERAGE | KELVIN | DIMENSIONS   | WEIGHT  | COLOR     | PACKING | PRICE (€) |
|---------------|-----------|------|----------|--------|--------------|---------|-----------|---------|-----------|
| 5207227067518 | 147-69360 | 20W  | 100mA    | 6500K  | 162x144x28mm | 0,410kg | DARK GREY | 1/30    | 24.65     |
| 5207227067532 | 147-69361 | 20W  | 100mA    | 4200K  | 162x144x28mm | 0,410kg | DARK GREY | 1/30    | 24.65     |
| 5207227067556 | 147-69362 | 30W  | 150mA    | 6500K  | 200x180x28mm | 0,620kg | DARK GREY | 1/20    | 35.55     |
| 5207227067570 | 147-69363 | 30W  | 150mA    | 4200K  | 200x180x28mm | 0,620kg | DARK GREY | 1/20    | 35.55     |
| 5207227067594 | 147-69364 | 50W  | 250mA    | 6500K  | 245x210x31mm | 0,920kg | DARK GREY | 1/10    | 52.00     |
| 5207227067662 | 147-69365 | 50W  | 250mA    | 4200K  | 245x210x31mm | 0,920kg | DARK GREY | 1/10    | 52.00     |

PROJECTOR LED SMD • ΠΡΟΒΟΛΕΙΣ LED SMD



PRODUCTION MATERIAL: **ALUMINIUM & GLASS**  
ΥΛΙΚΟ ΚΑΤΑΣΚΕΥΗΣ: **ΑΛΟΥΜΙΝΙΟ & ΓΥΑΛΙ**

| BARCODE       | CODE      | WATT | AMPERAGE | KELVIN | DIMENSIONS   | WEIGHT  | COLOR | PACKING | PRICE (€) |
|---------------|-----------|------|----------|--------|--------------|---------|-------|---------|-----------|
| 5206139014351 | 147-69270 | 10W  | 50mA     | GREEN  | 127x113x22mm | 0.230kg | BLACK | 1/60    | 13.35     |
| 5206139014368 | 147-69271 | 20W  | 100mA    | GREEN  | 162x136x24mm | 0.350kg | BLACK | 1/40    | 21.65     |

PRODUCTION MATERIAL: **ALUMINIUM & GLASS**  
ΥΛΙΚΟ ΚΑΤΑΣΚΕΥΗΣ: **ΑΛΟΥΜΙΝΙΟ & ΓΥΑΛΙ**



| BARCODE       | CODE      | WATT | AMPERAGE | KELVIN | DIMENSIONS   | WEIGHT | COLOR | PACKING | PRICE (€) |
|---------------|-----------|------|----------|--------|--------------|--------|-------|---------|-----------|
| 5207227068782 | 147-69390 | 50W  | 560mA    | RGB    | 240x210x44mm | 12.6kg | BLACK | 1/10    | 46.60     |

PROJECTOR LED COB • ΠΡΟΒΟΛΕΙΣ LED COB



PRODUCTION MATERIAL: **ALUMINIUM & GLASS**  
ΥΛΙΚΟ ΚΑΤΑΣΚΕΥΗΣ: **ΑΛΟΥΜΙΝΙΟ & ΓΥΑΛΙ**

| BARCODE       | CODE      | WATT | AMPERAGE | KELVIN | DIMENSIONS    | WEIGHT  | COLOR | PACKING | PRICE (€) |
|---------------|-----------|------|----------|--------|---------------|---------|-------|---------|-----------|
| 5207227021299 | 147-69230 | 10W  | 280mA    | 6500K  | 112x85x70mm   | 0,442kg | GREY  | 1/30    | 16.25     |
| 5207227021312 | 147-69236 | 20W  | 560mA    | 6500K  | 178x138x85mm  | 0,867kg | GREY  | 1/15    | 26.25     |
| 5207227021275 | 147-69239 | 30W  | 840mA    | 6500K  | 224x184x105mm | 1,316kg | GREY  | 1/10    | 37.85     |

PROJECTOR LED SMD • ΠΡΟΒΟΛΕΙΣ LED SMD



PRODUCTION MATERIAL: **ALUMINIUM**  
ΥΛΙΚΟ ΚΑΤΑΣΚΕΥΗΣ: **ΑΛΟΥΜΙΝΙΟ**

| BARCODE       | CODE      | WATT | AMPERAGE | KELVIN | DIMENSIONS   | WEIGHT  | COLOR | PACKING | PRICE (€) |
|---------------|-----------|------|----------|--------|--------------|---------|-------|---------|-----------|
| 5207227070174 | 147-69380 | 10W  | 1A       | 4000K  | 162x147x36mm | 0,610kg | BLACK | 1/40    | 25.60     |
| 5207227070198 | 147-69381 | 20W  | 2A       | 4000K  | 181x162x36mm | 0,750kg | BLACK | 1/20    | 39.60     |
| 5207227070211 | 147-69382 | 30W  | 3A       | 4000K  | 235x205x36mm | 1,250kg | BLACK | 1/10    | 52.60     |

**PROJECTOR LED SMD MOVEABLE • ΠΡΟΒΟΛΕΙΣ LED SMD ΦΟΡΗΤΟΙ**

PRODUCTION MATERIAL: **ALUMINIUM & GLASS**  
ΥΛΙΚΟ ΚΑΤΑΣΚΕΥΗΣ: **ΑΛΟΥΜΙΝΙΟ & ΓΥΑΛΙ**

**NEW!**



IP65 ENERGY CLASS A+ VOLT 220-240V 50-60Hz LUMENS 80/W SMD 2835 CLASS I GROUNDING

BEAM ANGLE 120° PF >0.9 Ra >80 IK 07 15000 ON-OFF 30000h LIFE TIME START TIME min: 0.5 sec -25°C ~ +45°C OPERATING TEMP.

| BARCODE       | CODE      | WATT | AMPERAGE | KELVIN | DIMENSIONS    | WEIGHT | COLOR | PACKING | PRICE (€) |
|---------------|-----------|------|----------|--------|---------------|--------|-------|---------|-----------|
| 5207227068744 | 147-69370 | 10W  | 48mA     | 4000K  | 146x164x240mm | 18kg   | BLACK | 1/20    | 24.85     |
| 5207227068768 | 147-69372 | 30W  | 145mA    | 4000K  | 189x183x280mm | 14kg   | BLACK | 1/10    | 39.80     |

White Box with Sticker PACKING

**PROJECTOR LED COB RECHARGEABLE • ΠΡΟΒΟΛΕΙΣ LED COB ΕΠΑΝΑΦΟΡΤΙΖΟΜΕΝΟΙ**

PRODUCTION MATERIAL: **ALUMINIUM & PLASTIC & IRON**  
ΥΛΙΚΟ ΚΑΤΑΣΚΕΥΗΣ: **ΑΛΟΥΜΙΝΙΟ & ΠΛΑΣΤΙΚΟ & ΣΙΔΗΡΟΣ**

BATTERY TYPE: 18650 Lithium 3,7V  
Charging cable: 8,4V 1A



IP65 ENERGY CLASS A+ VOLT 100-240V 50-60Hz LUMENS 85/W COB 30 charging time 3 Hrs discharge time 4/5 Hrs

BEAM ANGLE 120° PF >0.6 Ra >70 IK 08 25000 ON-OFF 25000h LIFE TIME START TIME min: 3 sec -20°C ~ +50°C OPERATING TEMP.

| BARCODE       | CODE      | WATT | AMPERAGE | LUMENS | DIMENSIONS    | WEIGHT  | COLOR  | PACKING | PRICE (€) |
|---------------|-----------|------|----------|--------|---------------|---------|--------|---------|-----------|
| 5206139050212 | 147-69240 | 10W  | 260mA    | 4000K  | 265x135x126mm | 0,950kg | YELLOW | 1/20    | 40.60     |
| 5206139050236 | 147-69241 | 20W  | 260mA    | 4000K  | 298x160x184mm | 1,500kg | YELLOW | 1/10    | 69.60     |

CAR ADAPTOR

Color Box PACKING

**BASE FOR LED PROJECTOR • ΒΑΣΗ ΓΙΑ ΠΡΟΒΟΛΕΙΣ LED**

PRODUCTION MATERIAL: **ALUMINIUM**  
ΥΛΙΚΟ ΚΑΤΑΣΚΕΥΗΣ: **ΑΛΟΥΜΙΝΙΟ**



White Box with Sticker PACKING

| BARCODE       | CODE      | DESCRIPTION   | WEIGHT   | PACKING | PRICE (€) |
|---------------|-----------|---|----------|---------|-----------|
| 5206139044891 | 147-22422 | BASE FOR LED PROJECTOR 3 LEGS 10-50W YELLOW 960x1500mm / 1.000 kg<br>ΒΑΣΗ ΓΙΑ ΠΡΟΒΟΛΕΙΣ LED ΜΕ ΤΡΙΠΟΔΑ 10-50W ΚΙΤΡΙΝΗ 960x1500mm / 1.000 kg | 1.000 kg | 1/6     | 30.90     |
| 5206139044914 | 147-22420 | BASE FOR LED PROJECTOR 20W YELLOW 265x205x75mm / 0.500 kg<br>ΒΑΣΗ ΓΙΑ ΠΡΟΒΟΛΕΙΣ LED 20W ΚΙΤΡΙΝΗ 265x205x75mm / 0.500 kg                     | 0.500 kg | 1/20    | 7.70      |
| 5206139044945 | 147-22421 | BASE FOR LED PROJECTOR 50W YELLOW 345x280x105mm / 1.020 kg<br>ΒΑΣΗ ΓΙΑ ΠΡΟΒΟΛΕΙΣ LED 50W ΚΙΤΡΙΝΗ 345x280x105mm / 1.020 kg                   | 1.020 kg | 1/20    | 13.85     |

**PROJECTOR LED SMD SOLAR • ΠΡΟΒΟΛΕΑΣ LED SMD ΗΛΙΑΚΟΣ**

PRODUCTION MATERIAL: **ALUMINIUM & GLASS**  
ΥΛΙΚΟ ΚΑΤΑΣΚΕΥΗΣ: **ΑΛΟΥΜΙΝΙΟ & ΓΥΑΛΙ**

BATTERY TYPE: Lithium: 3.2V 10000mAh  
SOLAR PANEL SIZE: 350x280x17mm

**NEW!**



IP65 ENERGY CLASS A+ VOLT 6V DC LUMENS 85/W SMD 2835 charging time 5-8 Hrs discharge time 10-20 Hrs 25°C ~ +45°C OPERATING TEMP.

BEAM ANGLE 120° PF >0.8 Ra >80 IK 07 15000 ON-OFF 30000h LIFE TIME START TIME min: 0.5 sec INSTALLATION HEIGHT 5-8M

| BARCODE       | CODE      | WATT | AMPERAGE | KELVIN | DIMENSIONS    | WEIGHT | COLOR | PACKING | PRICE (€) |
|---------------|-----------|------|----------|--------|---------------|--------|-------|---------|-----------|
| 5207227013188 | 147-69590 | 20W  | 50mA     | 4000K  | 190x450x219mm | 16,0kg | BLACK | 1/5     | 96.60     |

White Box with Sticker PACKING

**PROJECTOR LED SMD SOLAR • ΠΡΟΒΟΛΕΑΣ LED SMD ΗΛΙΑΚΟΣ**

PRODUCTION MATERIAL: **ALUMINIUM & GLASS**  
ΥΛΙΚΟ ΚΑΤΑΣΚΕΥΗΣ: **ΑΛΟΥΜΙΝΙΟ & ΓΥΑΛΙ**

BATTERY TYPE: Lithium: 3.2V 20000mAh  
SOLAR PANEL SIZE: 350x350x17mm

**NEW!**



IP65 ENERGY CLASS A+ VOLT 6V DC LUMENS 85/W SMD 2835 charging time 5-8 Hrs discharge time 10-20 Hrs 25°C ~ +45°C OPERATING TEMP.

BEAM ANGLE 120° PF >0.8 Ra >80 IK 07 15000 ON-OFF 30000h LIFE TIME START TIME min: 0.5 sec INSTALLATION HEIGHT 5-8M

| BARCODE       | CODE      | WATT | AMPERAGE | KELVIN | DIMENSIONS    | WEIGHT | COLOR | PACKING | PRICE (€) |
|---------------|-----------|------|----------|--------|---------------|--------|-------|---------|-----------|
| 5207227068805 | 147-69592 | 50W  | 100mA    | 4000K  | 228x460x315mm | 22,0kg | BLACK | 1/5     | 134.00    |

White Box with Sticker PACKING

**PROJECTOR LED SMD SOLAR • ΠΡΟΒΟΛΕΑΣ LED SMD ΗΛΙΑΚΟΣ**

PRODUCTION MATERIAL: **ALUMINIUM & GLASS**  
ΥΛΙΚΟ ΚΑΤΑΣΚΕΥΗΣ: **ΑΛΟΥΜΙΝΙΟ & ΓΥΑΛΙ**

BATTERY TYPE: LifePO4: 3.2V 2400mAh  
SOLAR PANEL SIZE: 340x570x25mm

WITH MOVEMENT DETECTOR & DETECTION DISTANCE 6-8m  
ΜΕ ΑΝΙΧΝΕΥΤΗ ΚΙΝΗΣΗΣ & ΑΠΟΣΤΑΣΗ ΑΝΙΧΝΕΥΣΗΣ 6-8m

**NEW!**



IP66 ENERGY CLASS A+ VOLT 5V DC LUMENS 85/W SMD 5630 charging time 4-5 Hrs discharge time 10-20 Hrs 25°C ~ +45°C OPERATING TEMP.

BEAM ANGLE 120° PF >0.8 Ra >80 IK 07 15000 ON-OFF 30000h LIFE TIME START TIME min: 0.5 sec INSTALLATION HEIGHT 5-8M

| BARCODE       | CODE      | WATT | AMPERAGE | KELVIN | DIMENSIONS   | WEIGHT | COLOR | PACKING | PRICE (€) |
|---------------|-----------|------|----------|--------|--------------|--------|-------|---------|-----------|
| 5207227068836 | 147-69593 | 30W  | 50mA     | 6500K  | 80x275x210mm | 32,5kg | WHITE | 1/6     | 179.60    |

White Box with Sticker PACKING

**EXTENSION CORD 2m FOR 147-69590 PROJECTOR LED SMD SOLAR**  
**ΠΡΟΕΚΤΑΣΗ ΚΑΛΩΔΙΟΥ 2m ΓΙΑ 147-69590 ΠΡΟΒΟΛΕΑΣ LED SMD ΗΛΙΑΚΟΣ**

PRODUCTION MATERIAL: **COPPER & PVC**  
ΥΛΙΚΟ ΚΑΤΑΣΚΕΥΗΣ: **ΧΑΛΚΟΣ & PVC**



White Box with Sticker PACKING

| BARCODE       | CODE      | DESCRIPTION  | WEIGHT | PACKING | PRICE (€) |
|---------------|-----------|--|--------|---------|-----------|
| 5207227029530 | 147-13252 | EXTENSION CORD 2m FOR 147-69590 PROJECTOR LED SMD SOLAR<br>ΠΡΟΕΚΤΑΣΗ ΚΑΛΩΔΙΟΥ 2m ΓΙΑ 147-69590 ΠΡΟΒΟΛΕΑΣ LED SMD ΗΛΙΑΚΟΣ | 1/500  | 1/500   | 6.65      |

PROJECTOR LED SMD MODULAR • ΠΡΟΒΟΛΕΙΣ LED SMD MODULAR

PRODUCTION MATERIAL: **ALUMINIUM**  
ΥΛΙΚΟ ΚΑΤΑΣΚΕΥΗΣ: **ΑΛΟΥΜΙΝΙΟ**



| BARCODE       | CODE      | WATT | AMPERAGE            | KELVIN | DIMENSIONS     | COLOR | PACKING | PRICE (€) |  |
|---------------|-----------|------|---------------------|--------|----------------|-------|---------|-----------|--|
| 5207227035319 | 146-69100 | 250W | 115V/2,2A-230V/1,1A | 5700K  | 483x296x1345mm | BLACK | 1/1     | 565.00    |  |
| 5207227035326 | 146-69101 | 250W | 115V/2,2A-230V/1,1A | 4000K  | 483x296x1345mm | BLACK | 1/1     | 565.00    |  |

BRACKET ARMS FOR MODULAR PROJECTORS • ΒΑΣΕΙΣ ΠΡΟΒΟΛΕΑ MODULAR

PRODUCTION MATERIAL: **ALUMINIUM**  
ΥΛΙΚΟ ΚΑΤΑΣΚΕΥΗΣ: **ΑΛΟΥΜΙΝΙΟ**

|  |               |           |   |  |  |  |     |                     |
|--|---------------|-----------|---|--|--|--|-----|---------------------|
|  | 5207227035333 | 146-69110 | BRACKET ARM SINGLE TRUNNION 250W BLACK<br>ΒΑΣΗ ΠΡΟΒΟΛΕΑ ΜΟΝΗ TRUNNION 250W ΜΑΥΡΗ          |  |  |  | 1/1 | PRICE (€)<br>32.90  |
|  | 5207227035340 | 146-69111 | BRACKET ARM DOUBLE TRUNNION 500W BLACK<br>ΒΑΣΗ ΠΡΟΒΟΛΕΑ ΔΙΠΛΗ TRUNNION 500W ΜΑΥΡΗ         |  |  |  | 1/1 | PRICE (€)<br>282.00 |
|  | 5207227035357 | 146-69112 | BRACKET ARM TRIPLE TRUNNION 750W BLACK<br>ΒΑΣΗ ΠΡΟΒΟΛΕΑ ΤΡΙΠΛΗ TRUNNION 750W ΜΑΥΡΗ        |  |  |  | 1/1 | PRICE (€)<br>318.00 |
|  | 5207227035364 | 146-69113 | BRACKET ARM QUADRUPLE TRUNNION 1000W BLACK<br>ΒΑΣΗ ΠΡΟΒΟΛΕΑ ΤΕΤΡΑΠΛΗ TRUNNION 1000W ΜΑΥΡΗ |  |  |  | 1/1 | PRICE (€)<br>348.00 |

BRACKET ARMS FOR MODULAR PROJECTORS • ΒΑΣΕΙΣ ΠΡΟΒΟΛΕΑ MODULAR

PRODUCTION MATERIAL: **ALUMINIUM**  
ΥΛΙΚΟ ΚΑΤΑΣΚΕΥΗΣ: **ΑΛΟΥΜΙΝΙΟ**

|  |               |           |   |  |  |  |     |                     |
|--|---------------|-----------|---|--|--|--|-----|---------------------|
|  | 5207227035371 | 146-69115 | MOUNT KIT TRIPLE KNUCKLE 750W BLACK<br>ΒΑΣΗ ΤΡΙΠΛΗ KNUCKLE 750W ΜΑΥΡΗ   |  |  |  | 1/1 | PRICE (€)<br>108.00 |
|  | 5207227035388 | 146-69116 | PARKING MOUNT QUADRUPLE LUMOSA TINY 1000W BLACK<br>ΒΑΣΗ ΠΡΟΒΟΛΕΑ ΓΙΑ PARKING ΤΕΤΡΑΠΛΗ LUMOSA TINY 1000W ΜΑΥΡΗ |  |  |  | 1/1 | PRICE (€)<br>196.00 |

LASER FOR ADJUSTMENT MODULAR PROJECTOR • ΛΕΙΖΕΡ ΡΥΘΜΙΣΗΣ ΠΡΟΒΟΛΕΑ

PRODUCTION MATERIAL: **ALUMINIUM**  
ΥΛΙΚΟ ΚΑΤΑΣΚΕΥΗΣ: **ΑΛΟΥΜΙΝΙΟ**

BATTERY TYPE: 16340

|  |               |           |  |  |  |  |  |                     |
|--|---------------|-----------|--|--|--|--|--|---------------------|
|  | 5207227035395 | 146-69117 | LASER FOR ADJUSTMENT MODULAR PROJECTOR 250W<br>ΛΕΙΖΕΡ ΡΥΘΜΙΣΗΣ ΠΡΟΒΟΛΕΑ 250W |  |  |  |  |                     |
|  |               |           |  |  |  |  |  | PRICE (€)<br>146.00 |



RECESSED LED LIGHTS FOR GAS STATIONS • ΦΩΤΙΣΤΙΚΑ ΧΩΝΕΥΤΑ ΜΙΚΤΟΥ ΦΩΤΙΣΜΟΥ ΓΙΑ ΒΕΝΖΙΝΑΔΙΚΑ

**NEW!**  
 PRODUCTION MATERIAL: **SPCC & POLYCARBONATE**  
 ΥΛΙΚΟ ΚΑΤΑΣΚΕΥΗΣ: **SPCC & ΠΟΛΥΚΑΡΒΟΝΙΚΟ**



5 YEARS GUARANTEE

IP65 ENERGY CLASS A++ VOLT 100-240V 50-60Hz LUMENS 130/W mA 1,44A CLASS I GROUNDING Cutting dimension 360x360mm SMD 3030 kg 2,450Kg

BEAM ANGLE 120° Flicker free PF >0.92 Ra >80 IK 07 25000 ON-OFF 50000h LIFE TIME START TIME min: 1 sec INSTALLATION HEIGHT 6-12M -30°C ~ +50°C OPERATING TEMP.

| BARCODE       | CODE      | WATT | KELVIN | DIMENSIONS   | COLOR | PACKING | PRICE (€) |
|---------------|-----------|------|--------|--------------|-------|---------|-----------|
| 5207227059155 | 147-56321 | 75W  | 5000K  | 400x400x76mm | WHITE | 1/1     | 272.00    |

White Box with Sticker PACKING

**NEW!**  
 MOVEMENT DETECTOR / DETECTION DISTANCE 6-12m  
 ΑΝΙΧΝΕΥΤΗΣ ΚΙΝΗΣΗΣ / ΑΠΟΣΤΑΣΗ ΑΝΙΧΝΕΥΣΗΣ 6-12m  
 PRODUCTION MATERIAL: **PLASTIC & METALLIC**  
 ΥΛΙΚΟ ΚΑΤΑΣΚΕΥΗΣ: **ΠΛΑΣΤΙΚΟ & ΜΕΤΑΛΛΟ**



5 YEARS GUARANTEE

IP65 VOLT 220-240V 50-60Hz SENSOR TYPE PIR BEAM ANGLE 220° IK 07 25000 ON-OFF 50000h LIFE TIME START TIME min: 0.5 sec INSTALLATION HEIGHT max 15M -35°C ~ +70°C OPERATING TEMP. MOUNTING BASE 50x50mm

When motion detected, but sufficient daylight, light remains OFF. When motion detected, insufficient daylight, light ON. After the stand-by period, light is OFF.  
 Μόλις ανιχνευθεί κίνηση, σε επαρκές φως της ημέρας, το φως παραμένει σβηστό. Μόλις ανιχνευθεί κίνηση, σε μη επαρκές φως της ημέρας, το φως ανάβει. Μετά το διάστημα αναμονής, το φως σβήνει.

| BARCODE       | CODE      | WATT  | DIMENSIONS | COLOR | PACKING | PRICE (€) |
|---------------|-----------|-------|------------|-------|---------|-----------|
| 5207227059162 | 147-56322 | 1200W | ø80x70mm   | GREY  | 1/1     | 116.00    |

White Box with Sticker PACKING

RECESSED LIGHT LED SMD  
 ΦΩΤΙΣΤΙΚΟ ΧΩΝΕΥΤΟ LED SMD  
 PRODUCTION MATERIAL: **METALLIC**  
 ΥΛΙΚΟ ΚΑΤΑΣΚΕΥΗΣ: **ΜΕΤΑΛΛΙΚΟ**

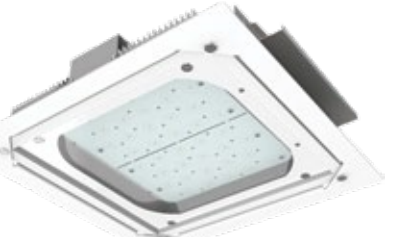

2 YEARS GUARANTEE

IP44 ENERGY CLASS A+ VOLT 220-240V 50-60Hz LUMENS 110/W CLASS II GROUNDING Cutting dimension 360x360mm kg 6,060Kg

BEAM ANGLE 200° Flicker free PF >0.9 Ra >80 IK 08 15000 ON-OFF 50000h LIFE TIME START TIME min: 0.5 sec -15°C ~ +50°C OPERATING TEMP.

| BARCODE       | CODE      | WATT | KELVIN | DIMENSIONS    | COLOR | PACKING | PRICE (€) |
|---------------|-----------|------|--------|---------------|-------|---------|-----------|
| 5207227073861 | 147-56320 | 90W  | 6500K  | 400x400x120mm | WHITE | 1/1     | 435.00    |

Brown Box with Sticker PACKING

PRODUCTION MATERIAL: **METALLIC**  
 ΥΛΙΚΟ ΚΑΤΑΣΚΕΥΗΣ: **ΜΕΤΑΛΛΙΚΟ**



2 YEARS GUARANTEE

IP44 VOLT 220-240V 50-60Hz BEAM ANGLE 120° IK 08 Cutting dimension 560x310mm GROUNDING -20°C ~ +60°C OPERATING TEMP. kg 3,200Kg

| BARCODE       | CODE      | WATT        | DIMENSIONS    | COLOR | PACKING | PRICE (€) |
|---------------|-----------|-------------|---------------|-------|---------|-----------|
| 5207227073854 | 147-56310 | max 60W LED | 330x580x110mm | WHITE | 1/1     | 98.60     |

Brown Box with Sticker PACKING

METAL FLOOD LIGHT HQI • ΠΡΟΒΟΛΕΙΣ ΜΕΤΑΛΛΟΥ HQI

PRODUCTION MATERIAL: **ALUMINIUM**  
 ΥΛΙΚΟ ΚΑΤΑΣΚΕΥΗΣ: **ΑΛΟΥΜΙΝΙΟ**  
 WITH MAGNETIC BALLAST



1 YEAR GUARANTEE

IP65 VOLT 220-240V 50-60Hz BEAM ANGLE 120° TYPE HQI BASE E40 kg 7,500Kg -20°C ~ +45°C OPERATING TEMP. GROUNDING

| BARCODE       | CODE      | WATT | DIMENSIONS    | COLOR | PACKING | PRICE (€) |
|---------------|-----------|------|---------------|-------|---------|-----------|
| 5206139323057 | 147-68305 | 400W | 410x510x135mm | BLACK | 1/2     | 118.00    |
| 5206139323071 | 147-68307 | 250W | 410x510x145mm | BLACK | 1/2     | 114.00    |

Brown Box with Sticker PACKING

EMPTY FLOOD LIGHT • ΠΡΟΒΟΛΕΙΣ ΚΕΝΟΙ

PRODUCTION MATERIAL: **METALLIC**  
 ΥΛΙΚΟ ΚΑΤΑΣΚΕΥΗΣ: **ΜΕΤΑΛΛΙΚΟ**



2 YEARS GUARANTEE

IP65 BEAM ANGLE 200° BASE E40 -25°C ~ +50°C OPERATING TEMP. GROUNDING

| BARCODE       | CODE      | WATT      | DIMENSIONS    | WEIGHT   | COLOR | PACKING | PRICE (€) |
|---------------|-----------|-----------|---------------|----------|-------|---------|-----------|
| 5206139323156 | 147-68315 | max 1000W | 550x470x160mm | 6,900kg  | BLACK | 1/1     | 248.00    |
| 5206139323231 | 147-68323 | max 2000W | 590x495x295mm | 10,200kg | BLACK | 1/1     | 387.00    |

Brown Box with Sticker PACKING

IGNITION SYSTEM • ΣΥΣΤΗΜΑ ΕΝΑΥΣΗΣ

PRODUCTION MATERIAL: **METALLIC & COPPER**  
 ΥΛΙΚΟ ΚΑΤΑΣΚΕΥΗΣ: **ΜΕΤΑΛΛΟ & ΧΑΛΚΟΣ**



2 YEARS GUARANTEE

IP20 VOLT 220-240V 50-60Hz mA 10,30A -25°C ~ +50°C OPERATING TEMP.

| CODE      | WATT  | DIMENSIONS    | WEIGHT   | COLOR | PACKING | PRICE (€) |
|-----------|-------|---------------|----------|-------|---------|-----------|
| 147-50901 | 2000W | 350x120x135mm | 14,200kg | WHITE | 1/1     | 312.00    |
| 147-50903 | 1000W | 350x120x90mm  | 11,900kg | WHITE | 1/1     | 205.00    |

Bulk PACKING

## Horticulture Grow LED Lights Φωτιστικά LED Ανάπτυξης Φυτών

# EUROLAMP®

Pioneers in New Technology !

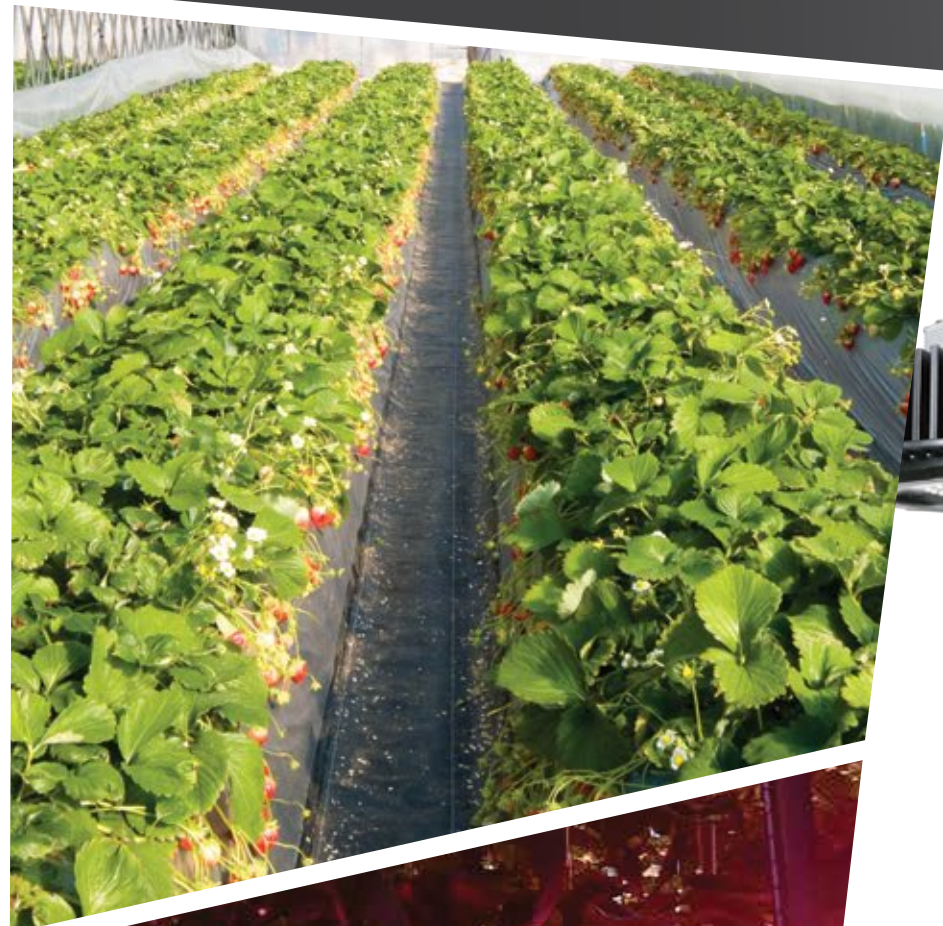

### Horti-Far



#### Applications / Εφαρμογές

- Greenhouses
- High rise vegetables
- Cut flowers
- Potted plants
- Scientific research
- Θερμοκήπια
- Λαχανικά ταχείας ανάπτυξης
- Λουλούδια
- Φυτά σε γλάστρα
- Επιστημονική έρευνα



### Horti-Spec



#### Applications / Εφαρμογές

- Greenhouses
- High rise vegetables
- Cut flowers
- Potted plants
- Scientific research
- Seed breeding
- Θερμοκήπια
- Λαχανικά ταχείας ανάπτυξης
- Λουλούδια
- Φυτά σε γλάστρα
- Επιστημονική έρευνα
- Σποροπαραγωγή



### Horti-Tube



#### Applications / Εφαρμογές

- Greenhouses
- High rise vegetables
- Cut flowers
- Potted plants
- Scientific research
- Seed breeding
- Θερμοκήπια
- Λαχανικά ταχείας ανάπτυξης
- Λουλούδια
- Φυτά σε γλάστρα
- Επιστημονική έρευνα
- Σποροπαραγωγή

Περισσότερες Πληροφορίες: [www.eurolamp.gr](http://www.eurolamp.gr)  
More Informations: [www.eurolampglobal.com](http://www.eurolampglobal.com)

Η **EUROLAMP**, πρωτοπόρος πάντα εταιρεία σε θέματα Τεχνολογίας, έχει την τιμή και την ευχαρίστηση να παρουσιάσει το νέο απόκτημα της συλλογής της:

Την Νέα Σειρά:  
**LED Φωτιστικών Ανάπτυξης Φυτών**

Εξελιγμένα LED chips, καθιστούν τις συνθήκες θερμοκηπίου ιδανικές για την ανάπτυξη των φυτών, μέσω της κατάλληλης ακτινοβολίας που εκπέμπουν στον χώρο. Με δυνατότητα εστίασης σε συγκεκριμένα φάσματα μήκους κύματος, έχουν τη δυνατότητα να καθίστανται ευεργετικά κάθε φορά για το συγκεκριμένο φυτό που καλλιεργείται.

Έτσι, για κάθε καλλιέργεια, είτε ιατρικής κάνναβης, είτε πράσινων λαχανικών ή λουλουδιών, είτε φράουλας ή τομάτας, υπάρχει κάποιο συγκεκριμένο μοντέλο φωτιστικού, που θα αποτελέσει έναν πολύτιμο βοηθό για τον επιχειρηματία.

Τέλος, η EUROLAMP πάντοτε κοντά στον επαγγελματία, θα ανταποκριθεί σε κάθε σας κάλεσμα για υπεύθυνες συμβουλές και προτάσεις, με γνώμονα φυσικά το project που σας ενδιαφέρει.

**EUROLAMP**, as a pioneer company in technology, has the honor and pleasure to present the new acquisition of its collection:

The New Series:  
**Horticulture Grow LED Lights**

The state of the art LED chips that are used, make greenhouse conditions ideal for plant growth, by emitting the appropriate radiation in each space.

By focusing on specific wavelength ranges, they have the potential to become beneficial for each particular plant cultivated.

Thus, for any crop, medicinal hemp, green vegetables, flowers, strawberries or even tomatoes, there is a specific lamp model that will be a valuable assistant to every entrepreneur/professional.

Lastly, EUROLAMP as always, will be close to the professional, by responding to every call for responsible advice and suggestions, focusing each time on the project you are interested in.

STREET LIGHTS LED SMD • ΦΩΤΙΣΤΙΚΑ ΔΡΟΜΟΥ LED SMD

PRODUCTION MATERIAL: ALUMINIUM  
ΥΛΙΚΟ ΚΑΤΑΣΚΕΥΗΣ: ΑΛΟΥΜΙΝΙΟ

STREET LIGHTS LED SMD • ΦΩΤΙΣΤΙΚΑ ΔΡΟΜΟΥ LED SMD

PRODUCTION MATERIAL: ALUMINIUM & PC  
ΥΛΙΚΟ ΚΑΤΑΣΚΕΥΗΣ: ΑΛΟΥΜΙΝΙΟ & PC

CONNECTION HOLE:  $\varnothing$  50mm



146-57000/1/2/3/4/5

CONNECTION HOLE:  $\varnothing$  60mm



146-57006/7/8/9/10/11

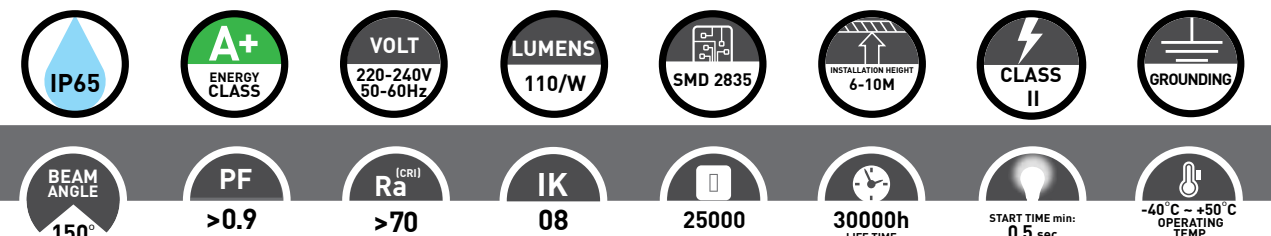

VALUE

2 YEARS WARRANTY

Brown Box with Sticker PACKING

| BARCODE       | CODE      | WATT | AMPERAGE | KELVIN | DIMENSIONS     | WEIGHT  | COLOR | PACKING | PRICE (€) |
|---------------|-----------|------|----------|--------|----------------|---------|-------|---------|-----------|
| 5207227039416 | 146-57000 | 30W  | 150mA    | 6500K  | 322x142x66mm   | 0,550kg | GREY  | 1/1     | 48.80     |
| 5207227039423 | 146-57001 | 30W  | 150mA    | 4000K  | 322x142x66mm   | 0,550kg | GREY  | 1/1     | 48.80     |
| 5207227039430 | 146-57002 | 30W  | 150mA    | 3000K  | 322x142x66mm   | 0,550kg | GREY  | 1/1     | 48.80     |
| 5207227029967 | 146-57003 | 50W  | 250mA    | 6500K  | 402x177x66mm   | 0,950kg | GREY  | 1/1     | 69.30     |
| 5207227029974 | 146-57004 | 50W  | 250mA    | 4000K  | 402x177x66mm   | 0,950kg | GREY  | 1/1     | 69.30     |
| 5207227029974 | 146-57004 | 50W  | 250mA    | 4000K  | 402x177x66mm   | 0,950kg | GREY  | 1/1     | 69.30     |
| 5207227039447 | 146-57005 | 50W  | 250mA    | 3000K  | 402x177x66mm   | 0,950kg | GREY  | 1/1     | 69.30     |
| 5207227029981 | 146-57006 | 70W  | 500mA    | 6500K  | 493x222x67.5mm | 1,600kg | GREY  | 1/1     | 96.60     |
| 5207227029998 | 146-57007 | 70W  | 500mA    | 4000K  | 493x222x67.5mm | 1,600kg | GREY  | 1/1     | 96.60     |
| 5207227039454 | 146-57008 | 70W  | 500mA    | 3000K  | 493x222x67.5mm | 1,600kg | GREY  | 1/1     | 96.60     |
| 5207227030000 | 146-57009 | 100W | 500mA    | 6500K  | 493x222x67.5mm | 1,650kg | GREY  | 1/1     | 129.80    |
| 5207227030017 | 146-57010 | 100W | 500mA    | 4000K  | 493x222x67.5mm | 1,650kg | GREY  | 1/1     | 129.80    |
| 5207227033100 | 146-57011 | 100W | 500mA    | 3000K  | 493x222x67.5mm | 1,650kg | GREY  | 1/1     | 129.80    |



CONNECTION HOLE:  $\varnothing$  60mm

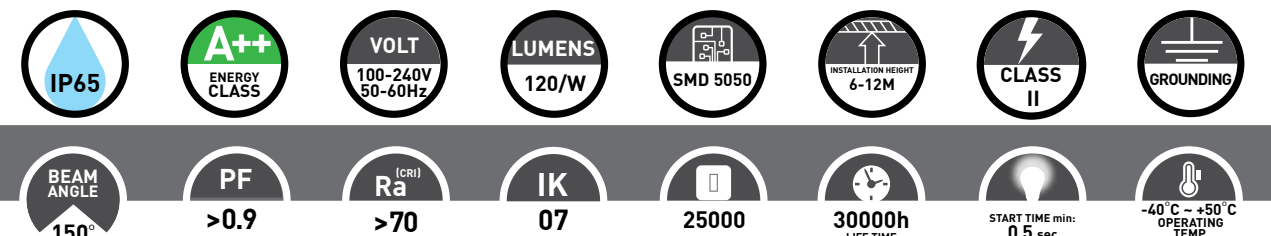

PLUS

3 YEARS WARRANTY

Brown Box with Sticker PACKING

| BARCODE       | CODE      | WATT | AMPERAGE | KELVIN | DIMENSIONS   | WEIGHT  | COLOR | PACKING | PRICE (€) |
|---------------|-----------|------|----------|--------|--------------|---------|-------|---------|-----------|
| 5207227039461 | 146-57026 | 150W | 750mA    | 6500K  | 635x316x80mm | 4,500kg | GREY  | 1/1     | 362.00    |
| 5207227039478 | 146-57027 | 150W | 750mA    | 4000K  | 635x316x80mm | 4,500kg | GREY  | 1/1     | 362.00    |
| 5207227039485 | 146-57028 | 150W | 750mA    | 3000K  | 635x316x80mm | 4,500kg | GREY  | 1/1     | 362.00    |



**NEW!**

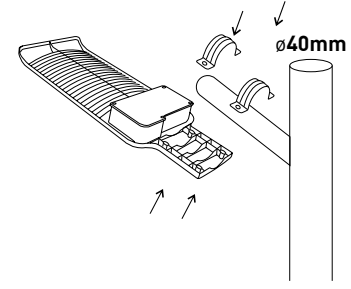

$\varnothing$ 40mm

PLUS

2 YEARS WARRANTY

Brown Box with Sticker PACKING

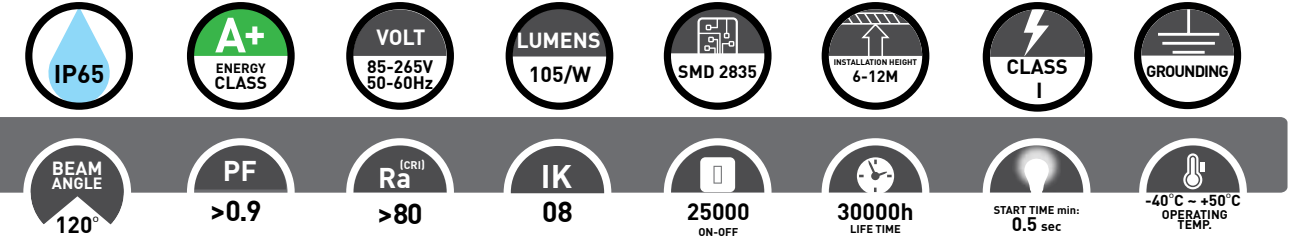

| BARCODE       | CODE      | WATT | AMPERAGE | KELVIN | DIMENSIONS   | WEIGHT  | COLOR | PACKING | PRICE (€) |
|---------------|-----------|------|----------|--------|--------------|---------|-------|---------|-----------|
| 5207227073533 | 146-57030 | 30W  | 200mA    | 6500K  | 330x115x52mm | 0,650kg | GREY  | 1/1     | 46.60     |
| 5207227073540 | 146-57031 | 30W  | 200mA    | 4000K  | 330x115x52mm | 0,650kg | GREY  | 1/1     | 46.60     |
| 5207227073557 | 146-57032 | 30W  | 200mA    | 3000K  | 330x115x52mm | 0,650kg | GREY  | 1/1     | 46.60     |
| 5207227073564 | 146-57033 | 40W  | 220mA    | 6500K  | 350x115x52mm | 0,650kg | GREY  | 1/1     | 66.85     |
| 5207227073571 | 146-57034 | 40W  | 220mA    | 4000K  | 350x115x52mm | 0,650kg | GREY  | 1/1     | 66.85     |
| 5207227073588 | 146-57035 | 40W  | 220mA    | 3000K  | 350x115x52mm | 0,650kg | GREY  | 1/1     | 66.85     |
| 5207227073595 | 146-57036 | 60W  | 300mA    | 6500K  | 430x150x62mm | 1,050kg | GREY  | 1/1     | 88.60     |
| 5207227073601 | 146-57037 | 60W  | 300mA    | 4000K  | 430x150x62mm | 1,050kg | GREY  | 1/1     | 88.60     |
| 5207227073618 | 146-57038 | 60W  | 300mA    | 3000K  | 430x150x62mm | 1,050kg | GREY  | 1/1     | 88.60     |
| 5207227073625 | 146-57039 | 90W  | 450mA    | 6500K  | 450x150x62mm | 1,150kg | GREY  | 1/1     | 123.00    |
| 5207227073632 | 146-57040 | 90W  | 450mA    | 4000K  | 450x150x62mm | 1,150kg | GREY  | 1/1     | 123.00    |
| 5207227073649 | 146-57041 | 90W  | 450mA    | 3000K  | 450x150x62mm | 1,150kg | GREY  | 1/1     | 123.00    |
| 5207227073656 | 146-57042 | 120W | 600mA    | 6500K  | 565x180x72mm | 1,500kg | GREY  | 1/1     | 158.00    |
| 5207227073663 | 146-57043 | 120W | 600mA    | 4000K  | 565x180x72mm | 1,500kg | GREY  | 1/1     | 158.00    |
| 5207227073670 | 146-57044 | 120W | 600mA    | 3000K  | 565x180x72mm | 1,500kg | GREY  | 1/1     | 158.00    |
| 5207227073687 | 146-57045 | 150W | 700mA    | 6500K  | 590x180x72mm | 1,850kg | GREY  | 1/1     | 192.00    |
| 5207227073694 | 146-57046 | 150W | 700mA    | 4000K  | 590x180x72mm | 1,850kg | GREY  | 1/1     | 192.00    |
| 5207227073700 | 146-57047 | 150W | 700mA    | 3000K  | 590x180x72mm | 1,850kg | GREY  | 1/1     | 192.00    |



STREET LIGHTS • ΦΩΤΙΣΤΙΚΑ ΔΡΟΜΟΥ

PRODUCTION MATERIAL: **METALLIC & POLYCARBONATE**  
ΥΛΙΚΟ ΚΑΤΑΣΚΕΥΗΣ: **ΜΕΤΑΛΛΟ & ΠΟΛΥΚΑΡΒΟΝΙΚΟ**

SELF BALLAST  
ΜΙΚΤΟΥ ΦΩΤΙΣΜΟΥ

E27 - E40

E40

550x240x190mm

755x353x276mm

| IP65          | VOLT<br>220-240V<br>50-60Hz | BEAM<br>ANGLE<br>120° | IK<br>06 | -20°C ~ +50°C<br>OPERATING<br>TEMP. | GROUNDING |       |         |           |
|---------------|-----------------------------|-----------------------|----------|-------------------------------------|-----------|-------|---------|-----------|
| BARCODE       | CODE                        | WATT                  | BASEHOLD | DIMENSIONS                          | WEIGHT    | COLOR | PACKING | PRICE (€) |
| 5206139402042 | 147-56204                   | max 30W LED           | E27      | 550x240x190mm                       | 3,600kg   | GREY  | 1/1     | 72.00     |
| 5206139402059 | 147-56205                   | max 58W LED           | E40      | 755x353x276mm                       | 4,100kg   | GREY  | 1/1     | 112.00    |

MERCURY-TYPE WITH CAPACITOR  
ΥΔΡΑΡΓΥΡΟΥ ΜΕ ΠΥΚΝΩΤΗ

| IP65          | VOLT<br>220-240V<br>50-60Hz | TYPE<br>HQL | IK<br>06 | BEAM<br>ANGLE<br>120° | -20°C ~ +50°C<br>OPERATING<br>TEMP. | GROUNDING |         |           |
|---------------|-----------------------------|-------------|----------|-----------------------|-------------------------------------|-----------|---------|-----------|
| BARCODE       | CODE                        | WATT        | BASEHOLD | DIMENSIONS            | WEIGHT                              | COLOR     | PACKING | PRICE (€) |
| 5206139402400 | 147-56240                   | 80W         | E27      | 550x240x190mm         | 3,600kg                             | GREY      | 1/1     | 81.00     |
| 5206139402417 | 147-56241                   | 125W        | E27      | 550x240x190mm         | 3,600kg                             | GREY      | 1/1     | 88.00     |

MERCURY-TYPE WITH CAPACITOR  
ΥΔΡΑΡΓΥΡΟΥ ΜΕ ΠΥΚΝΩΤΗ

| IP65          | VOLT<br>220-240V<br>50-60Hz | TYPE<br>HQL | IK<br>06 | BEAM<br>ANGLE<br>120° | -20°C ~ +50°C<br>OPERATING<br>TEMP. | GROUNDING |         |           |
|---------------|-----------------------------|-------------|----------|-----------------------|-------------------------------------|-----------|---------|-----------|
| BARCODE       | CODE                        | WATT        | BASEHOLD | DIMENSIONS            | WEIGHT                              | COLOR     | PACKING | PRICE (€) |
| 5206139402615 | 147-56261                   | 250W        | E40      | 550x240x190mm         | 4,100kg                             | GREY      | 1/1     | 96.60     |
| 5206139402646 | 147-56264                   | 250W        | E40      | 755x353x276mm         | 5,800kg                             | GREY      | 1/1     | 146.00    |
| 5206139402653 | 147-56265                   | 400W        | E40      | 755x353x276mm         | 6,250kg                             | GREY      | 1/1     | 162.00    |

SODIUM-TYPE WITH CAPACITOR  
ΝΑΤΡΙΟΥ ΜΕ ΠΥΚΝΩΤΗ

| IP65          | VOLT<br>220-240V<br>50-60Hz | TYPE<br>NAV | IK<br>06 | BEAM<br>ANGLE<br>120° | -20°C ~ +50°C<br>OPERATING<br>TEMP. | GROUNDING |         |           |
|---------------|-----------------------------|-------------|----------|-----------------------|-------------------------------------|-----------|---------|-----------|
| BARCODE       | CODE                        | WATT        | BASEHOLD | DIMENSIONS            | WEIGHT                              | COLOR     | PACKING | PRICE (€) |
| 5206139402424 | 147-56242                   | 70W         | E27      | 550x240x190mm         | 3,200kg                             | GREY      | 1/1     | 98.00     |
| 5207227073793 | 147-56246                   | 100W        | E40      | 550x240x190mm         | 3,850kg                             | GREY      | 1/1     | 104.00    |
| 5206139402431 | 147-56243                   | 150W        | E40      | 550x240x190mm         | 3,400kg                             | GREY      | 1/1     | 106.00    |
| 5206139402660 | 147-56266                   | 250W        | E40      | 755x353x276mm         | 5,100kg                             | GREY      | 1/1     | 166.00    |
| 5206139402677 | 147-56267                   | 400W        | E40      | 755x353x276mm         | 6,200kg                             | GREY      | 1/1     | 182.00    |



STREET LIGHTS • ΦΩΤΙΣΤΙΚΑ ΔΡΟΜΟΥ

PRODUCTION MATERIAL: **ALUMINIUM**  
ΥΛΙΚΟ ΚΑΤΑΣΚΕΥΗΣ: **ΑΛΟΥΜΙΝΙΟ**

SELF BALLAST  
ΜΙΚΤΟΥ ΦΩΤΙΣΜΟΥ

| IP65          | VOLT<br>220-240V<br>50-60Hz | BEAM<br>ANGLE<br>200° | IK<br>08 | -20°C ~ +60°C<br>OPERATING<br>TEMP. | GROUNDING | kg<br>3,000Kg |           |
|---------------|-----------------------------|-----------------------|----------|-------------------------------------|-----------|---------------|-----------|
| BARCODE       | CODE                        | WATT                  | BASEHOLD | DIMENSIONS                          | COLOR     | PACKING       | PRICE (€) |
| 5206139402004 | 147-56200                   | max 30W LED           | E27      | 580x275x200mm                       | ALUMINIUM | 1/1           | 82.45     |
| 5206139402011 | 147-56201                   | max 58W LED           | E40      | 690x320x290mm                       | ALUMINIUM | 1/1           | 96.85     |

MERCURY-TYPE WITH CAPACITOR  
ΥΔΡΑΡΓΥΡΟΥ ΜΕ ΠΥΚΝΩΤΗ

| IP65          | VOLT<br>220-240V<br>50-60Hz | TYPE<br>HQL | IK<br>08 | BEAM<br>ANGLE<br>120° | -20°C ~ +60°C<br>OPERATING<br>TEMP. | GROUNDING |         |           |
|---------------|-----------------------------|-------------|----------|-----------------------|-------------------------------------|-----------|---------|-----------|
| BARCODE       | CODE                        | WATT        | BASEHOLD | DIMENSIONS            | WEIGHT                              | COLOR     | PACKING | PRICE (€) |
| 5206139402103 | 147-56210                   | 80W         | E27      | 580x275x200mm         | 3,600kg                             | ALUMINIUM | 1/1     | 98.00     |
| 5206139402110 | 147-56211                   | 125W        | E27      | 580x275x200mm         | 3,600kg                             | ALUMINIUM | 1/1     | 112.00    |
| 5206139402127 | 147-56212                   | 250W        | E40      | 690x320x290mm         | 4,200kg                             | ALUMINIUM | 1/1     | 136.00    |
| 5206139402134 | 147-56213                   | 400W        | E40      | 690x320x290mm         | 4,200kg                             | ALUMINIUM | 1/1     | 156.00    |

SODIUM-TYPE WITH CAPACITOR  
ΝΑΤΡΙΟΥ ΜΕ ΠΥΚΝΩΤΗ

| IP65          | VOLT<br>220-240V<br>50-60Hz | TYPE<br>NAV | IK<br>08 | BEAM<br>ANGLE<br>120° | -20°C ~ +60°C<br>OPERATING<br>TEMP. | GROUNDING |         |           |
|---------------|-----------------------------|-------------|----------|-----------------------|-------------------------------------|-----------|---------|-----------|
| BARCODE       | CODE                        | WATT        | BASEHOLD | DIMENSIONS            | WEIGHT                              | COLOR     | PACKING | PRICE (€) |
| 5206139402301 | 147-56230                   | 70W         | E27      | 580x275x200mm         | 3,600kg                             | ALUMINIUM | 1/1     | 119.00    |
| 5206139402318 | 147-56231                   | 150W        | E40      | 580x275x200mm         | 3,600kg                             | ALUMINIUM | 1/1     | 122.00    |
| 5206139402332 | 147-56233                   | 250W        | E40      | 690x320x290mm         | 4,200kg                             | ALUMINIUM | 1/1     | 166.00    |
| 5206139402349 | 147-56234                   | 400W        | E40      | 690x320x290mm         | 4,200kg                             | ALUMINIUM | 1/1     | 182.00    |

BRACKETS & SPARE GLASSES • ΒΡΑΧΙΟΝΕΣ ΑΛΟΥΜΙΝΙΟΥ ΚΑΙ ΚΑΛΥΜΜΑΤΑ

PRODUCTION MATERIAL: **METALLIC**  
ΥΛΙΚΟ ΚΑΤΑΣΚΕΥΗΣ: **ΜΕΤΑΛΛΙΚΟ**



| kg<br>1,500Kg<br>3,500Kg* | Bulk<br>PACKING   |     |       |
|---------------------------|---|-----|-------|
| PRICE (€)                 | PRICE (€)   |     |       |
| 5206139394101 147-22410   | BRACKET FOR STREET LIGHT Φ42 1m "ERIBAN"<br>ΒΡΑΧΙΟΝΕΣ 1M Φ42 "ERIBAN" | 1/5 | 20.60 |
| 5207227072352 147-22411*  | BRACKET FOR STREET LIGHT 1m Φ60 "ERIBAN"<br>ΒΡΑΧΙΟΝΕΣ 1M Φ60 "ERIBAN" | 1/1 | 39.60 |



PRODUCTION MATERIAL: **ABS**  
ΥΛΙΚΟ ΚΑΤΑΣΚΕΥΗΣ: **ABS**

| kg<br>0,270Kg<br>0,320Kg* | Brown Box<br>with Sticker<br>PACKING  |     |       |
|---------------------------|---|-----|-------|
| PRICE (€)                 | PRICE (€)   |     |       |
| 5207227073779 147-99300   | SPARE CLASS ELITE (147-56290 & 147-56294) CLEAR<br>ΚΑΠΑΚΙΑ ΓΙΑ ΦΩΤΙΣΤΙΚΟ ΔΡΟΜΟΥ (147-56290 & 147-56294) CLEAR | 1/1 | 19.95 |
| 5207227073786 147-99301*  | SPARE CLASS ELITE (147-56291) CLEAR<br>ΚΑΠΑΚΙΑ ΓΙΑ ΦΩΤΙΣΤΙΚΟ ΔΡΟΜΟΥ (147-56291) CLEAR                         | 1/1 | 28.60 |

HIGH BAY LED SMD • ΚΑΜΠΑΝΕΣ LED SMD

PRODUCTION MATERIAL: **ALUMINIUM**  
ΥΛΙΚΟ ΚΑΤΑΣΚΕΥΗΣ: **ΑΛΟΥΜΙΝΙΟ**

UFO



| BARCODE       | CODE      | WATT | AMPERAGE | KELVIN | DIMENSIONS | WEIGHT  | COLOR | PACKING | PRICE (€) |
|---------------|-----------|------|----------|--------|------------|---------|-------|---------|-----------|
| 5207227028502 | 145-67100 | 50W  | 0.250A   | 6500K  | ø220x117mm | 0,700kg | BLACK | 1/1     | 78.60     |
| 5207227028519 | 145-67101 | 50W  | 0.250A   | 4000K  | ø220x117mm | 0,700kg | BLACK | 1/1     | 78.60     |
| 5207227028533 | 145-67103 | 100W | 0.500A   | 6500K  | ø280x130mm | 1,200kg | BLACK | 1/1     | 119.80    |
| 5207227028540 | 145-67104 | 100W | 0.500A   | 4000K  | ø280x130mm | 1,200kg | BLACK | 1/1     | 119.80    |
| 5207227028564 | 145-67106 | 150W | 0.750A   | 6500K  | ø360x140mm | 1,700kg | BLACK | 1/1     | 178.80    |
| 5207227028571 | 145-67107 | 150W | 0.750A   | 4000K  | ø360x140mm | 1,700kg | BLACK | 1/1     | 178.80    |
| 5207227028595 | 145-67109 | 200W | 1A       | 6500K  | ø420x160mm | 2,400kg | BLACK | 1/1     | 234.85    |
| 5207227028601 | 145-67110 | 200W | 1A       | 4000K  | ø420x160mm | 2,400kg | BLACK | 1/1     | 234.85    |

HIGH BAY LED SMD • ΚΑΜΠΑΝΕΣ LED SMD

PRODUCTION MATERIAL: **ALUMINIUM**  
ΥΛΙΚΟ ΚΑΤΑΣΚΕΥΗΣ: **ΑΛΟΥΜΙΝΙΟ**

UFO



| BARCODE       | CODE      | WATT | AMPERAGE | KELVIN | DIMENSIONS | WEIGHT  | COLOR | PACKING | PRICE (€) |
|---------------|-----------|------|----------|--------|------------|---------|-------|---------|-----------|
| 5207227073717 | 145-67123 | 100W | 0.500A   | 6500K  | ø280x130mm | 1,200kg | BLACK | 1/1     | 136.00    |
| 5207227073724 | 145-67124 | 100W | 0.500A   | 4000K  | ø280x130mm | 1,200kg | BLACK | 1/1     | 136.00    |
| 5207227073731 | 145-67126 | 150W | 0.750A   | 6500K  | ø360x145mm | 1,700kg | BLACK | 1/1     | 206.00    |
| 5207227073748 | 145-67127 | 150W | 0.750A   | 4000K  | ø360x145mm | 1,700kg | BLACK | 1/1     | 206.00    |
| 5207227073755 | 145-67129 | 200W | 1A       | 6500K  | ø420x160mm | 2,400kg | BLACK | 1/1     | 262.00    |
| 5207227073762 | 145-67130 | 200W | 1A       | 4000K  | ø420x160mm | 2,400kg | BLACK | 1/1     | 262.00    |

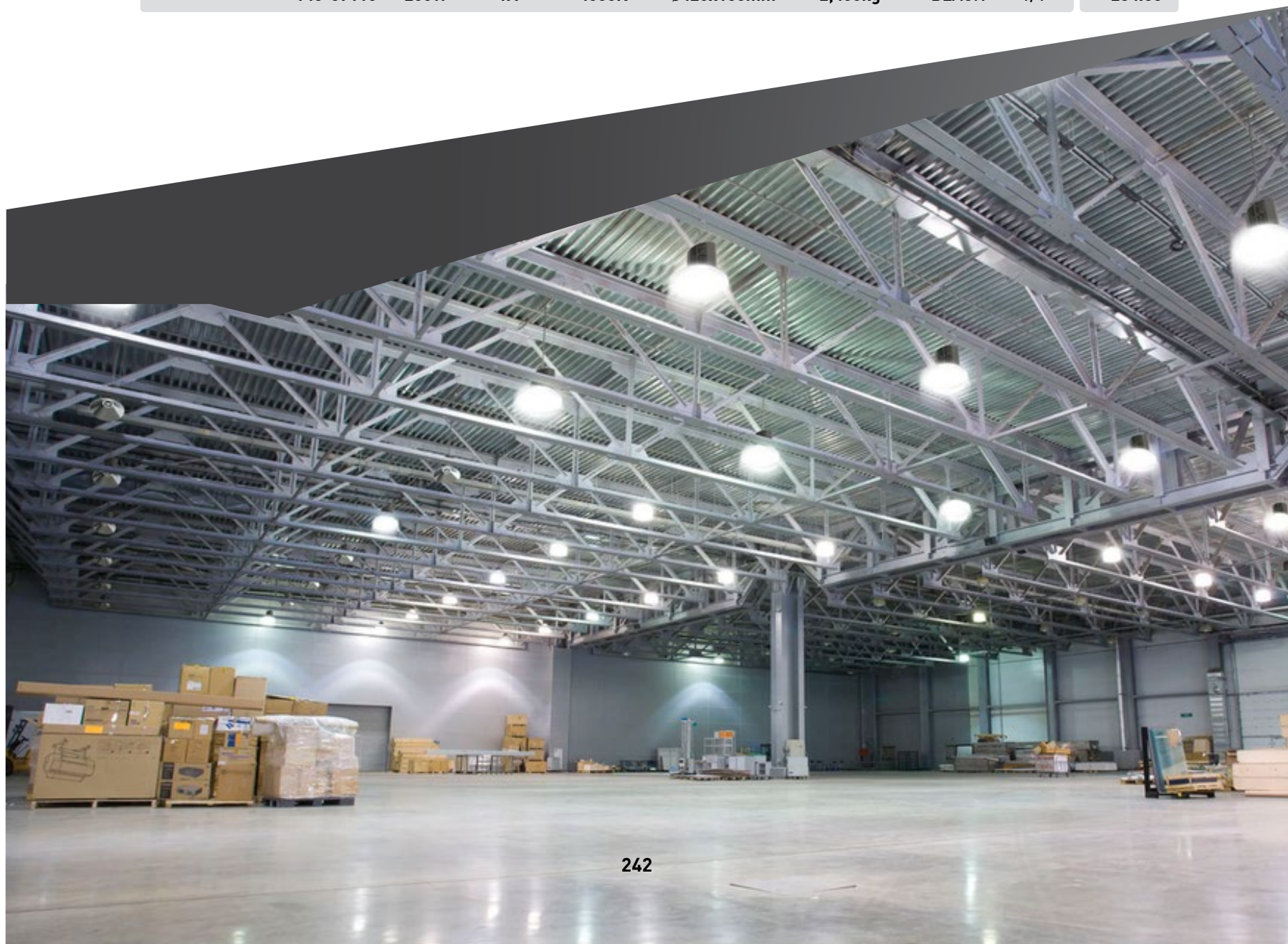



HIGH BAY LED SMD • ΚΑΜΠΑΝΕΣ LED SMD  
 PRODUCTION MATERIAL: ALUMINIUM / ALUMINIUM & PLASTIC  
 ΥΛΙΚΟ ΚΑΤΑΣΚΕΥΗΣ: ΑΛΟΥΜΙΝΙΟ / ΑΛΟΥΜΙΝΙΟ ΚΑΙ ΠΛΑΣΤΙΚΟ

POLYCARBONATE / G.BOX / HANGING BASE



White Box  
with Sticker  
PACKING



WATT  
max 58W  
LED

BASE  
E40

BEAM  
ANGLE  
60°

-20°C ~ +45°C  
OPERATING  
TEMP.

GROUNDING

| BARCODE       | CODE      | WATT        | DIMENSIONS | WEIGHT  | COLOR     | PACKING | PRICE (€) |
|---------------|-----------|-------------|------------|---------|-----------|---------|-----------|
| 5206139360014 | 147-67001 | max 58W LED | ø420x460mm | 3,200kg | CLEAR     | 1/1     | 88.20     |
| 5206139360038 | 147-67003 | max 58W LED | ø420x420mm | 2,100kg | ALUMINIUM | 1/1     | 48.80     |
| 5206139360021 | 147-67002 | max 58W LED | ø480x420mm | 2,750kg | ALUMINIUM | 1/1     | 43.60     |
| 5206139360083 | 147-67008 | max 58W LED | ø480x675mm | 3,700kg | ALUMINIUM | 1/1     | 74.80     |



Brown Box  
with Sticker  
PACKING

|               |           |   |     |           |
|---------------|-----------|---|-----|-----------|
| 5206139362629 | 147-67262 | PROTECTION GLASS FOR 147-68962,68964 ø480x10mm<br>ΠΡΟΣΤΑΤΕΥΤΙΚΟ ΓΥΑΛΙ ΚΑΜΠΑΝΑΣ ΓΙΑ ΚΩΔΙΚΟ 147-68962-68964 ø480x10mm | 1/5 | PRICE (€) |
|               |           |   |     | 19.65     |



## Φωτιστικά Εσωτερικού Χώρου

Ιδανικοί για χρήση σε χώρους όπως:

- Κατοικίες
- Καταστήματα
- Εμπορικά Κέντρα
- Αποθήκες
- Βιοτεχνικούς Χώρους
- Βιομηχανικούς Χώρους
- Μοτέλ
- Ξενοδοχεία
- Αίθουσες Διδασκαλίας
- Εκθεσιακούς Χώρους
- Μουσεία
- Αρχιτεκτονικές Δομές
- Δημόσιες Εγκαταστάσεις

## Indoor Lighting

Ideal for use in places as:

- Residences
- Stores
- Shopping Malls
- Warehouses
- Business Areas
- Industrial Areas
- Motels
- Hotels
- Teaching Rooms
- Exhibitions
- Museums
- Architectural Structures
- Public Facilities

BATHROOM LIGHT FIXTURES • ΦΩΤΙΣΤΙΚΑ ΜΠΑΝΙΟΥ



PRODUCTION MATERIAL: **STAINLESS STEEL & GLASS**  
ΥΛΙΚΟ ΚΑΤΑΣΚΕΥΗΣ: ΑΤΣΑΛΙ & ΓΥΑΛΙ



IP20 WATT max 5W LED BASE G9 -10°C ~ +60°C OPERATING TEMP. GROUNDING

| BARCODE       | CODE      | DIMENSIONS    | WEIGHT  | COLOR        | PACKING | PRICE (€) |
|---------------|-----------|---------------|---------|--------------|---------|-----------|
| 5207227065859 | 145-21000 | ø40x304x85mm  | 0,330kg | NICKEL SATIN | 1/40    | 52.85     |
| 5207227065873 | 145-21001 | ø35x330x90mm  | 0,750kg | NICKEL SATIN | 1/20    | 61.80     |
| 5207227065897 | 145-21002 | ø35x280x135mm | 0,470kg | NICKEL SATIN | 1/30    | 57.60     |



PRODUCTION MATERIAL: **STAINLESS STEEL & PLASTIC**  
ΥΛΙΚΟ ΚΑΤΑΣΚΕΥΗΣ: ΑΤΣΑΛΙ & ΠΛΑΣΤΙΚΟ



IP20 A+++ ENERGY CLASS VOLT 100-240V 50-60Hz LUMENS 70/W 90mA SMD 2835 CLASS I GROUNDING 0,600Kg

BEAM ANGLE 120° PF >0.50 Ra >80 IK 07 15000 ON-OFF 30000h LIFE TIME START TIME min: 0.5 sec -20°C ~ +45°C OPERATING TEMP.

| BARCODE       | CODE      | WATT | KELVIN | DIMENSIONS  | COLOR  | PACKING | PRICE (€) |
|---------------|-----------|------|--------|-------------|--------|---------|-----------|
| 5207227069048 | 145-21003 | 10W  | 4000K  | 450x50x90mm | NICKEL | 1/10    | 54.25     |



PRODUCTION MATERIAL: **IRON & GLASS**  
ΥΛΙΚΟ ΚΑΤΑΣΚΕΥΗΣ: ΣΙΔΗΡΟΣ & ΓΥΑΛΙ



KANALINA

IP20 VOLT 220V WATT max 7W LED WATT max 28W HALOGEN -20°C ~ +60°C OPERATING TEMP. GROUNDING

| BARCODE       | CODE      | BASE    | DIMENSIONS   | WEIGHT   | COLOR        | PACKING | PRICE (€) |
|---------------|-----------|---------|--------------|----------|--------------|---------|-----------|
| 5207227073151 | 145-21012 | 1 x E27 | 250x80x80xmm | 0.580 kg | NICKEL/WHITE | 1/20    | 29.00     |
| 5207227073168 | 145-21013 | 2 x E27 | 400x80x80mm  | 0.980 kg | NICKEL/WHITE | 1/12    | 47.20     |



BATHROOM LIGHT FIXTURES • ΦΩΤΙΣΤΙΚΑ ΜΠΑΝΙΟΥ

PRODUCTION MATERIAL: **IRON & GLASS**  
ΥΛΙΚΟ ΚΑΤΑΣΚΕΥΗΣ: ΣΙΔΗΡΟΣ & ΓΥΑΛΙ

MIRA



IP20 VOLT 220V WATT max 7W LED WATT max 28W HALOGEN -20°C ~ +60°C OPERATING TEMP. GROUNDING

| BARCODE       | CODE      | BASE    | DIMENSIONS  | WEIGHT   | COLOR        | PACKING | PRICE (€) |
|---------------|-----------|---------|-------------|----------|--------------|---------|-----------|
| 5207227073175 | 145-21014 | 1 x E14 | 80x300x60mm | 0.500 kg | NICKEL/WHITE | 1/20    | 48.80     |
| 5207227073199 | 145-21016 | 1 x E14 | 80x300x60mm | 0.500 kg | NICKEL/WHITE | 1/20    | 48.80     |

PRODUCTION MATERIAL: **IRON & GLASS**  
ΥΛΙΚΟ ΚΑΤΑΣΚΕΥΗΣ: ΣΙΔΗΡΟΣ & ΓΥΑΛΙ

MIRA



IP20 VOLT 220V WATT max 7W LED WATT max 28W HALOGEN -20°C ~ +60°C OPERATING TEMP. GROUNDING

| BARCODE       | CODE      | BASE    | DIMENSIONS   | WEIGHT   | COLOR        | PACKING | PRICE (€) |
|---------------|-----------|---------|--------------|----------|--------------|---------|-----------|
| 5207227073182 | 145-21015 | 2 x E14 | 200x130x80mm | 0.900 kg | NICKEL/WHITE | 1/20    | 71.20     |
| 5207227073205 | 145-21017 | 2 x E14 | 200x130x80mm | 0.900 kg | NICKEL/WHITE | 1/20    | 71.20     |

PRODUCTION MATERIAL: **IRON & GLASS**  
ΥΛΙΚΟ ΚΑΤΑΣΚΕΥΗΣ: ΣΙΔΗΡΟΣ & ΓΥΑΛΙ



IP20 VOLT 220V WATT max 7W LED WATT max 28W HALOGEN -20°C ~ +60°C OPERATING TEMP. GROUNDING

| BARCODE       | CODE      | BASE    | DIMENSIONS    | WEIGHT   | COLOR        | PACKING | PRICE (€) |
|---------------|-----------|---------|---------------|----------|--------------|---------|-----------|
| 5207227073212 | 145-21018 | 1 x E27 | 290x100x100mm | 0.820 kg | NICKEL/WHITE | 1/20    | 35.60     |
| 5207227073229 | 145-21019 | 2 x E27 | 400x100x100mm | 1.400 kg | NICKEL/WHITE | 1/12    | 44.50     |
| 5207227073236 | 145-21020 | 1 x E27 | 300x100x80mm  | 0.950 kg | NICKEL WHITE | 1/20    | 44.50     |

BATHROOM LIGHT FIXTURE • ΦΩΤΙΣΤΙΚΑ ΜΠΑΝΙΟΥ

PRODUCTION MATERIAL: **STAINLESS STEEL & ACRYLIC**  
ΥΛΙΚΟ ΚΑΤΑΣΚΕΥΗΣ: **ΑΤΣΑΛΙ & ΑΚΡΥΛΙΚΟ**



IRON 1

| BARCODE       | CODE      | WATT | AMPERAGE | KELVIN | DIMENSIONS  | WEIGHT  | COLOR  | PACKING | PRICE (€) |
|---------------|-----------|------|----------|--------|-------------|---------|--------|---------|-----------|
| 5207227065910 | 145-21100 | 6W   | 280mA    | 4000K  | 440x70x40mm | 0,390kg | NICKEL | 1/20    | 47.80     |
| 5207227065934 | 145-21101 | 8W   | 280mA    | 4000K  | 570x70x40mm | 0,450kg | NICKEL | 1/20    | 52.55     |

PRODUCTION MATERIAL: **ALUMINIUM & ACRYLIC**  
ΥΛΙΚΟ ΚΑΤΑΣΚΕΥΗΣ: **ΑΛΟΥΜΙΝΙΟ & ΑΚΡΥΛΙΚΟ**



IRON 2

| BARCODE       | CODE      | WATT | AMPERAGE | KELVIN | DIMENSIONS  | WEIGHT  | COLOR  | PACKING | PRICE (€) |
|---------------|-----------|------|----------|--------|-------------|---------|--------|---------|-----------|
| 5207227065958 | 145-21102 | 6W   | 280mA    | 4000K  | 450x55x40mm | 0,240kg | NICKEL | 1/20    | 42.65     |
| 5207227065972 | 145-21103 | 8W   | 280mA    | 4000K  | 590x55x40mm | 0,290kg | NICKEL | 1/20    | 52.30     |

PRODUCTION MATERIAL: **ALUMINIUM & PLASTIC**  
ΥΛΙΚΟ ΚΑΤΑΣΚΕΥΗΣ: **ΑΛΟΥΜΙΝΙΟ & ΠΛΑΣΤΙΚΟ**



IRON 3

| BARCODE       | CODE      | WATT | AMPERAGE | KELVIN | DIMENSIONS  | WEIGHT  | COLOR  | PACKING | PRICE (€) |
|---------------|-----------|------|----------|--------|-------------|---------|--------|---------|-----------|
| 5207227063176 | 145-21104 | 10W  | 80mA     | 4000K  | 605x65x54mm | 0,568kg | NICKEL | 1/12    | 51.60     |

BATHROOM LIGHT FIXTURE • ΦΩΤΙΣΤΙΚΑ ΜΠΑΝΙΟΥ

PRODUCTION MATERIAL: **ALUMINIUM & PLASTIC**  
ΥΛΙΚΟ ΚΑΤΑΣΚΕΥΗΣ: **ΑΛΟΥΜΙΝΙΟ & ΠΛΑΣΤΙΚΟ**



IRON 4

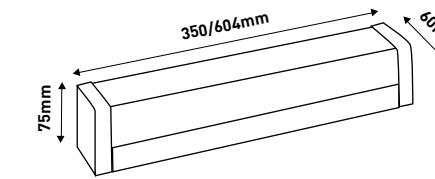

| BARCODE       | CODE      | WATT | AMPERAGE | KELVIN | DIMENSIONS  | WEIGHT  | COLOR      | PACKING | PRICE (€) |
|---------------|-----------|------|----------|--------|-------------|---------|------------|---------|-----------|
| 5207227063190 | 145-21105 | 8W   | 70mA     | 4000K  | 350x75x60mm | 0,479kg | NICKEL MAT | 1/12    | 42.20     |
| 5207227063213 | 145-21106 | 16W  | 130mA    | 4000K  | 604x75x60mm | 0,742kg | NICKEL MAT | 1/12    | 58.50     |

PRODUCTION MATERIAL: **ALUMINIUM & PLASTIC**  
ΥΛΙΚΟ ΚΑΤΑΣΚΕΥΗΣ: **ΑΛΟΥΜΙΝΙΟ & ΠΛΑΣΤΙΚΟ**



IRON 5

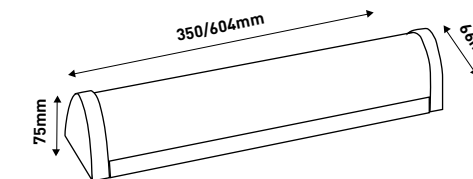

| BARCODE       | CODE      | WATT | AMPERAGE | KELVIN | DIMENSIONS  | WEIGHT  | COLOR      | PACKING | PRICE (€) |
|---------------|-----------|------|----------|--------|-------------|---------|------------|---------|-----------|
| 5207227063237 | 145-21107 | 8W   | 70mA     | 4000K  | 350x75x66mm | 0,438kg | NICKEL MAT | 1/12    | 40.60     |
| 5207227063251 | 145-21108 | 16W  | 130mA    | 4000K  | 604x75x66mm | 0,706kg | NICKEL MAT | 1/12    | 56.65     |

BATHROOM LIGHT FIXTURES • ΦΩΤΙΣΤΙΚΑ ΜΠΑΝΙΟΥ

PRODUCTION MATERIAL: ALUMINUM & NaNo PC  
ΥΛΙΚΟ ΚΑΤΑΣΚΕΥΗΣ: ΑΛΟΥΜΙΝΙΟ & NaNo PC

**NANO PC** **NEW!**

PLUS 2 YEARS WARRANTY

White Box with Sticker PACKING

| IP44            | A ENERGY CLASS | VOLT 230V 50-60Hz | LUMENS 80/W | SMD 2835 | CLASS II     | 0.218kg          | -20°C ~ +45°C OPERATING TEMP. |           |
|-----------------|----------------|-------------------|-------------|----------|--------------|------------------|-------------------------------|-----------|
| BEAM ANGLE 144° | PF >0.5        | PF >0.5           | Ra >80      | IK 03    | 15000 ON-OFF | 30000h LIFE TIME | START TIME min: 0.5 sec       |           |
| BARCODE         | CODE           | WATT              | AMPERAGE    | KELVIN   | DIMENSIONS   | COLOR            | PACKING                       | PRICE (€) |
| 5207227063114   | 145-21505      | 6W                | 60mA        | 3000K    | 400x116x53mm | NICKEL           | 1/20                          | 36.60     |

PRODUCTION MATERIAL: ALUMINUM & PLASTIC  
ΥΛΙΚΟ ΚΑΤΑΣΚΕΥΗΣ: ΑΛΟΥΜΙΝΙΟ & ΠΛΑΣΤΙΚΟ

**NEW!**

PLUS 2 YEARS WARRANTY

White Box with Sticker PACKING

| IP44            | A ENERGY CLASS | VOLT 230V 50-60Hz | LUMENS 80/W | SMD 2835 | CLASS II     | 0.275kg          | -20°C ~ +45°C OPERATING TEMP. |           |
|-----------------|----------------|-------------------|-------------|----------|--------------|------------------|-------------------------------|-----------|
| BEAM ANGLE 116° | PF >0.5        | PF >0.5           | Ra >80      | IK 03    | 15000 ON-OFF | 30000h LIFE TIME | START TIME min: 0.5 sec       |           |
| BARCODE         | CODE           | WATT              | AMPERAGE    | KELVIN   | DIMENSIONS   | COLOR            | PACKING                       | PRICE (€) |
| 5207227063138   | 145-21506      | 8W                | 80mA        | 3000K    | 400x106x42mm | NICKEL           | 1/20                          | 46.55     |

PRODUCTION MATERIAL: ALUMINUM & PLASTIC  
ΥΛΙΚΟ ΚΑΤΑΣΚΕΥΗΣ: ΑΛΟΥΜΙΝΙΟ & ΠΛΑΣΤΙΚΟ

**NEW!**

PLUS 2 YEARS WARRANTY

White Box with Sticker PACKING

| IP44            | A ENERGY CLASS | VOLT 230V 50-60Hz | LUMENS 80/W | SMD 2835 | CLASS II     | 0.318kg          | -20°C ~ +45°C OPERATING TEMP. |           |
|-----------------|----------------|-------------------|-------------|----------|--------------|------------------|-------------------------------|-----------|
| BEAM ANGLE 116° | PF >0.5        | PF >0.5           | Ra >80      | IK 03    | 15000 ON-OFF | 30000h LIFE TIME | START TIME min: 0.5 sec       |           |
| BARCODE         | CODE           | WATT              | AMPERAGE    | KELVIN   | DIMENSIONS   | COLOR            | PACKING                       | PRICE (€) |
| 5207227063152   | 145-21507      | 8W                | 80mA        | 3000K    | 400x121x42mm | NICKEL           | 1/20                          | 48.55     |

LIGHT FIXTURES TABLEAU • ΦΩΤΙΣΤΙΚΑ ΠΙΝΑΚΟΣ

**NEW!**

PRODUCTION MATERIAL: ALUMINUM, IRON, STAINLESS STEEL & ACRYLIC  
ΥΛΙΚΟ ΚΑΤΑΣΚΕΥΗΣ: ΑΛΟΥΜΙΝΙΟ, ΣΙΔΗΡΟΣ, ΑΤΣΑΛΙ & ΑΚΡΥΛΙΚΟ

PRO 2 YEARS WARRANTY

White Box with Sticker PACKING

| IP20            | A++ ENERGY CLASS | VOLT 100-240V 50-60Hz | LUMENS 60/W | SMD 2835 | CLASS I      | GROUNDING        | 0,750Kg                 |           |
|-----------------|------------------|-----------------------|-------------|----------|--------------|------------------|-------------------------|-----------|
| BEAM ANGLE 120° | PF >0.5          | PF >0.5               | Ra >80      | IK 07    | 15000 ON-OFF | 30000h LIFE TIME | START TIME min: 0.5 sec |           |
| BARCODE         | CODE             | WATT                  | AMPERAGE    | KELVIN   | DIMENSIONS   | COLOR            | PACKING                 | PRICE (€) |
| 5207227068942   | 145-21500        | 10W                   | 90mA        | 3000K    | 480x60x145mm | NICKEL           | 1/10                    | 74.30     |

**NEW!**

PLUS 2 YEARS WARRANTY

White Box with Sticker PACKING

| IP20            | A++ ENERGY CLASS | VOLT 100-240V 50-60Hz | LUMENS 70/W | SMD 2835 | CLASS I      | GROUNDING        | 0,780Kg                 |           |
|-----------------|------------------|-----------------------|-------------|----------|--------------|------------------|-------------------------|-----------|
| BEAM ANGLE 120° | PF >0.5          | PF >0.5               | Ra >80      | IK 07    | 15000 ON-OFF | 30000h LIFE TIME | START TIME min: 0.5 sec |           |
| BARCODE         | CODE             | WATT                  | AMPERAGE    | KELVIN   | DIMENSIONS   | COLOR            | PACKING                 | PRICE (€) |
| 5207227068966   | 145-21501        | 8W                    | 70mA        | 3000K    | 500x70x130mm | SATIN            | 1/10                    | 74.80     |

**NEW!**

PLUS 2 YEARS WARRANTY

White Box with Sticker PACKING

| IP20            | A++ ENERGY CLASS | VOLT 100-240V 50-60Hz | LUMENS 70/W | SMD 2835 | CLASS I      | GROUNDING        | 0,650Kg                 |           |
|-----------------|------------------|-----------------------|-------------|----------|--------------|------------------|-------------------------|-----------|
| BEAM ANGLE 120° | PF >0.5          | PF >0.5               | Ra >80      | IK 07    | 15000 ON-OFF | 30000h LIFE TIME | START TIME min: 0.5 sec |           |
| BARCODE         | CODE             | WATT                  | AMPERAGE    | KELVIN   | DIMENSIONS   | COLOR            | PACKING                 | PRICE (€) |
| 5207227068980   | 145-21502        | 9W                    | 80mA        | 3000K    | 390x50x150mm | WHITE            | 1/10                    | 53.90     |
| 5207227069000   | 145-21503        | 9W                    | 80mA        | 3000K    | 390x50x150mm | BLACK            | 1/10                    | 53.90     |

**NEW!**

PLUS 2 YEARS WARRANTY

White Box with Sticker PACKING

| IP20            | A++ ENERGY CLASS | VOLT 100-240V 50-60Hz | LUMENS 50/W | SMD 2835 | CLASS I       | GROUNDING        | 0,730Kg                 |           |
|-----------------|------------------|-----------------------|-------------|----------|---------------|------------------|-------------------------|-----------|
| BEAM ANGLE 120° | PF >0.5          | PF >0.5               | Ra >80      | IK 07    | 15000 ON-OFF  | 30000h LIFE TIME | START TIME min: 0.5 sec |           |
| BARCODE         | CODE             | WATT                  | AMPERAGE    | KELVIN   | DIMENSIONS    | COLOR            | PACKING                 | PRICE (€) |
| 5207227069024   | 145-21504        | 9W                    | 80mA        | 3000K    | 420x140x170mm | SATIN            | 1/10                    | 64.30     |

LIGHT READING FIXTURES FOR BED • ΑΠΛΙΚΕΣ ΚΡΕΒΑΤΙΟΥ ΑΝΑΓΝΩΣΗΣ



PRODUCTION MATERIAL: **METALLIC & FABRIC**  
ΥΛΙΚΟ ΚΑΤΑΣΚΕΥΗΣ: **ΜΕΤΑΛΛΟ & ΥΦΑΣΜΑ**

FAROS

| IP20          | ENERGY CLASS A | VOLT 85-265V 50-60Hz | LUMENS 85/W | SMD 2835     | CLASS I          | GROUNDING               | 1,500Kg                       | PRO 2 YEARS WARRANTY           |
|---------------|----------------|----------------------|-------------|--------------|------------------|-------------------------|-------------------------------|--------------------------------|
| TYPE LED CREE | FLICKER FREE   | PF >0.9              | Ra >80      | 25000 ON-OFF | 60000h LIFE TIME | START TIME min: 0.5 sec | -35°C ~ +50°C OPERATING TEMP. | White Box with Sticker PACKING |
| BARCODE       | CODE           | WATT                 | AMPERAGE    | KELVIN       | DIMENSIONS       | COLOR                   | PACKING                       | PRICE (€)                      |
| 5207227068157 | 145-22000      | 1xE27 & 3W           | 90mA        | 3000K        | 180x390x190mm    | NICKEL                  | 1/12                          | 96.00                          |



PRODUCTION MATERIAL: **METALLIC & FABRIC**  
ΥΛΙΚΟ ΚΑΤΑΣΚΕΥΗΣ: **ΜΕΤΑΛΛΟ & ΥΦΑΣΜΑ**

LORA

| IP20          | ENERGY CLASS A | VOLT 85-265V 50-60Hz | LUMENS 85/W | SMD 2835     | CLASS I          | GROUNDING               | 1,500Kg                       | PRO 2 YEARS WARRANTY           |
|---------------|----------------|----------------------|-------------|--------------|------------------|-------------------------|-------------------------------|--------------------------------|
| TYPE LED CREE | FLICKER FREE   | PF >0.9              | Ra >80      | 25000 ON-OFF | 60000h LIFE TIME | START TIME min: 0.5 sec | -35°C ~ +50°C OPERATING TEMP. | White Box with Sticker PACKING |
| BARCODE       | CODE           | WATT                 | AMPERAGE    | KELVIN       | DIMENSIONS       | COLOR                   | PACKING                       | PRICE (€)                      |
| 5207227068164 | 145-22001      | 1xE27 & 3W           | 90mA        | 3000K        | 190x440x200mm    | NICKEL                  | 1/12                          | 124.00                         |

LIGHT READING FIXTURES FOR BED • ΑΠΛΙΚΕΣ ΚΡΕΒΑΤΙΟΥ ΑΝΑΓΝΩΣΗΣ



PRODUCTION MATERIAL: **ALUMINIUM, ACRYLIC & IRON**  
ΥΛΙΚΟ ΚΑΤΑΣΚΕΥΗΣ: **ΑΛΟΥΜΙΝΙΟ, ΑΚΡΥΛΙΚΟ & ΣΙΔΗΡΟΣ**

NEFELI

1 USB PORT & PERIMETRIC LED LIGHT  
1 ΘΥΡΑ USB & ΠΕΡΙΜΕΤΡΙΚΟ ΦΩΤΙΣΜΟ LED

| IP20          | ENERGY CLASS A | VOLT 85-265V 50-60Hz | LUMENS 85/W | SMD 2835     | CLASS I          | GROUNDING               | 2,000Kg                       | PRO 2 YEARS WARRANTY           |
|---------------|----------------|----------------------|-------------|--------------|------------------|-------------------------|-------------------------------|--------------------------------|
| TYPE LED CREE | FLICKER FREE   | PF >0.9              | Ra >80      | 25000 ON-OFF | 60000h LIFE TIME | START TIME min: 0.5 sec | -35°C ~ +50°C OPERATING TEMP. | White Box with Sticker PACKING |
| BARCODE       | CODE           | WATT                 | AMPERAGE    | KELVIN       | DIMENSIONS       | COLOR                   | PACKING                       | PRICE (€)                      |
| 5207227068171 | 145-22002      | 8W & 3W              | 330mA       | 3000K        | 300x120x110mm    | WHITE                   | 1/12                          | 136.00                         |



PRODUCTION MATERIAL: **ALUMINIUM, ACRYLIC & IRON**  
ΥΛΙΚΟ ΚΑΤΑΣΚΕΥΗΣ: **ΑΛΟΥΜΙΝΙΟ, ΑΚΡΥΛΙΚΟ & ΣΙΔΗΡΟΣ**

LINA

1 USB PORT & PERIMETRIC LED LIGHT  
1 ΘΥΡΑ USB & ΠΕΡΙΜΕΤΡΙΚΟ ΦΩΤΙΣΜΟ LED

| IP20          | ENERGY CLASS A | VOLT 85-265V 50-60Hz | LUMENS 85/W | SMD 2835     | CLASS I          | GROUNDING               | 1,200Kg                       | PRO 2 YEARS WARRANTY           |
|---------------|----------------|----------------------|-------------|--------------|------------------|-------------------------|-------------------------------|--------------------------------|
| TYPE LED CREE | FLICKER FREE   | PF >0.9              | Ra >80      | 25000 ON-OFF | 60000h LIFE TIME | START TIME min: 0.5 sec | -35°C ~ +50°C OPERATING TEMP. | White Box with Sticker PACKING |
| BARCODE       | CODE           | WATT                 | AMPERAGE    | KELVIN       | DIMENSIONS       | COLOR                   | PACKING                       | PRICE (€)                      |
| 5207227069093 | 145-22004      | 4W & 3W              | 210mA       | 3000K        | 120x135x415mm    | WHITE                   | 1/12                          | 114.00                         |
| 5207227069116 | 145-22005      | 4W & 3W              | 210mA       | 3000K        | 120x135x415mm    | BLACK                   | 1/12                          | 114.00                         |



252



253



LIGHT READING FIXTURES FOR BED • ΑΠΛΙΚΕΣ ΚΡΕΒΑΤΙΟΥ ΑΝΑΓΝΩΣΗΣ



PRODUCTION MATERIAL: **ALUMINIUM & GLASS**  
ΥΛΙΚΟ ΚΑΤΑΣΚΕΥΗΣ: **ΑΛΟΥΜΙΝΙΟ & ΓΥΑΛΙ**

IOLI



| BARCODE       | CODE      | WATT | AMPERAGE | KELVIN | DIMENSIONS  | COLOR | PACKING | PRICE (€) |
|---------------|-----------|------|----------|--------|-------------|-------|---------|-----------|
| 5207227066351 | 145-22066 | 3W   | 300mA    | 3000K  | 80x35x410mm | WHITE | 1/25    | 36.45     |
| 5207227066375 | 145-22067 | 3W   | 300mA    | 3000K  | 80x35x410mm | WHITE | 1/25    | 36.45     |

WALL MOUNTED LED FIXTURES • ΑΠΛΙΚΕΣ ΤΟΙΧΟΥ LED



PRODUCTION MATERIAL: **METALLIC**  
ΥΛΙΚΟ ΚΑΤΑΣΚΕΥΗΣ: **ΜΕΤΑΛΛΙΚΟ**

XENIA



| BARCODE       | CODE      | BASE   | DIMENSIONS  | WEIGHT   | COLOR          | PACKING | PRICE (€) |
|---------------|-----------|--------|-------------|----------|----------------|---------|-----------|
| 5207227068201 | 145-22250 | 2 x G9 | 90x60x310mm | 0.800 kg | WHITE & NICKEL | 1/20    | 72.60     |
| 5207227068218 | 145-22251 | 2 x G9 | 90x60x310mm | 0.800 kg | ANTIQUÉ BRONZE | 1/20    | 72.60     |

WALL MOUNTED LED FIXTURES • ΑΠΛΙΚΕΣ ΤΟΙΧΟΥ LED



PRODUCTION MATERIAL: **METALLIC**  
ΥΛΙΚΟ ΚΑΤΑΣΚΕΥΗΣ: **ΜΕΤΑΛΛΙΚΟ**

ROTA



| BARCODE       | CODE      | BASE | DIMENSIONS    | COLOR                | PACKING | PRICE (€) |
|---------------|-----------|------|---------------|----------------------|---------|-----------|
| 5207227073243 | 145-22300 | E27  | 150x150x200mm | WHITE & NATURAL WOOD | 1/10    | 119.40    |
| 5207227073250 | 145-22301 | E27  | 150x150x200mm | BLACK & NATURAL WOOD | 1/10    | 119.40    |



PRODUCTION MATERIAL: **METALLIC**  
ΥΛΙΚΟ ΚΑΤΑΣΚΕΥΗΣ: **ΜΕΤΑΛΛΙΚΟ**

ZENIA



| BARCODE       | CODE      | BASE   | DIMENSIONS          | WEIGHT   | COLOR          | PACKING | PRICE (€) |
|---------------|-----------|--------|---------------------|----------|----------------|---------|-----------|
| 5207227068225 | 145-22252 | 2 x G9 | 60x60x750mm         | 1.300 kg | ANTIQUÉ BRONZE | 1/10    | 96.80     |
| 5207227073380 | 145-23100 | 2 x G9 | 750x60x900(cable)mm | 1.600 kg | ANTIQUÉ BRONZE | 1/10    | 132.00    |

WALL MOUNTED LED FIXTURES • ΑΠΛΙΚΕΣ ΤΟΙΧΟΥ LED

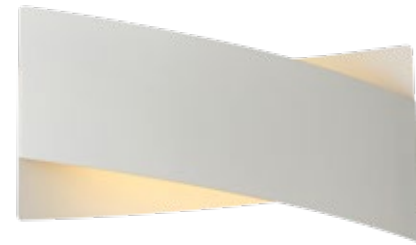

**NEW!**

PRODUCTION MATERIAL: **IRON & ACRYLIC**  
ΥΛΙΚΟ ΚΑΤΑΣΚΕΥΗΣ: **ΣΙΔΗΡΟΣ & ΑΚΡΥΛΙΚΟ**

XL



IP20 ENERGY CLASS A+ VOLT 85-265V 50-60Hz LUMENS 63/W SMD 2835 CLASS I 20°C - +65°C OPERATING TEMP. 0,720Kg

BEAM ANGLE 120° PF >0.5 Ra >80 10000 ON-OFF 5000h LIFE TIME START TIME min: 0.5 sec GROUNDING

| BARCODE       | CODE      | WATT | AMPERAGE | KELVIN | DIMENSIONS   | COLOR | PACKING | PRICE (€) |
|---------------|-----------|------|----------|--------|--------------|-------|---------|-----------|
| 5207227068485 | 145-22200 | 12W  | 460mA    | 3000K  | 250x120x80mm | WHITE | 1/20    | 72.85     |

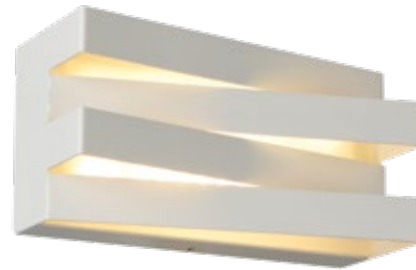

**NEW!**

PRODUCTION MATERIAL: **IRON & ACRYLIC**  
ΥΛΙΚΟ ΚΑΤΑΣΚΕΥΗΣ: **ΣΙΔΗΡΟΣ & ΑΚΡΥΛΙΚΟ**

MYRON



IP20 ENERGY CLASS A+ VOLT 85-265V 50-60Hz LUMENS 63/W SMD 2835 CLASS I 20°C - +65°C OPERATING TEMP. 0,640Kg

BEAM ANGLE 120° PF >0.5 Ra >80 10000 ON-OFF 5000h LIFE TIME START TIME min: 0.5 sec GROUNDING

| BARCODE       | CODE      | WATT | AMPERAGE | KELVIN | DIMENSIONS   | COLOR | PACKING | PRICE (€) |
|---------------|-----------|------|----------|--------|--------------|-------|---------|-----------|
| 5207227068508 | 145-22201 | 12W  | 460mA    | 3000K  | 200x100x80mm | WHITE | 1/20    | 61.55     |
| 5207227068522 | 145-22202 | 12W  | 460mA    | 3000K  | 200x100x80mm | BLACK | 1/20    | 61.55     |

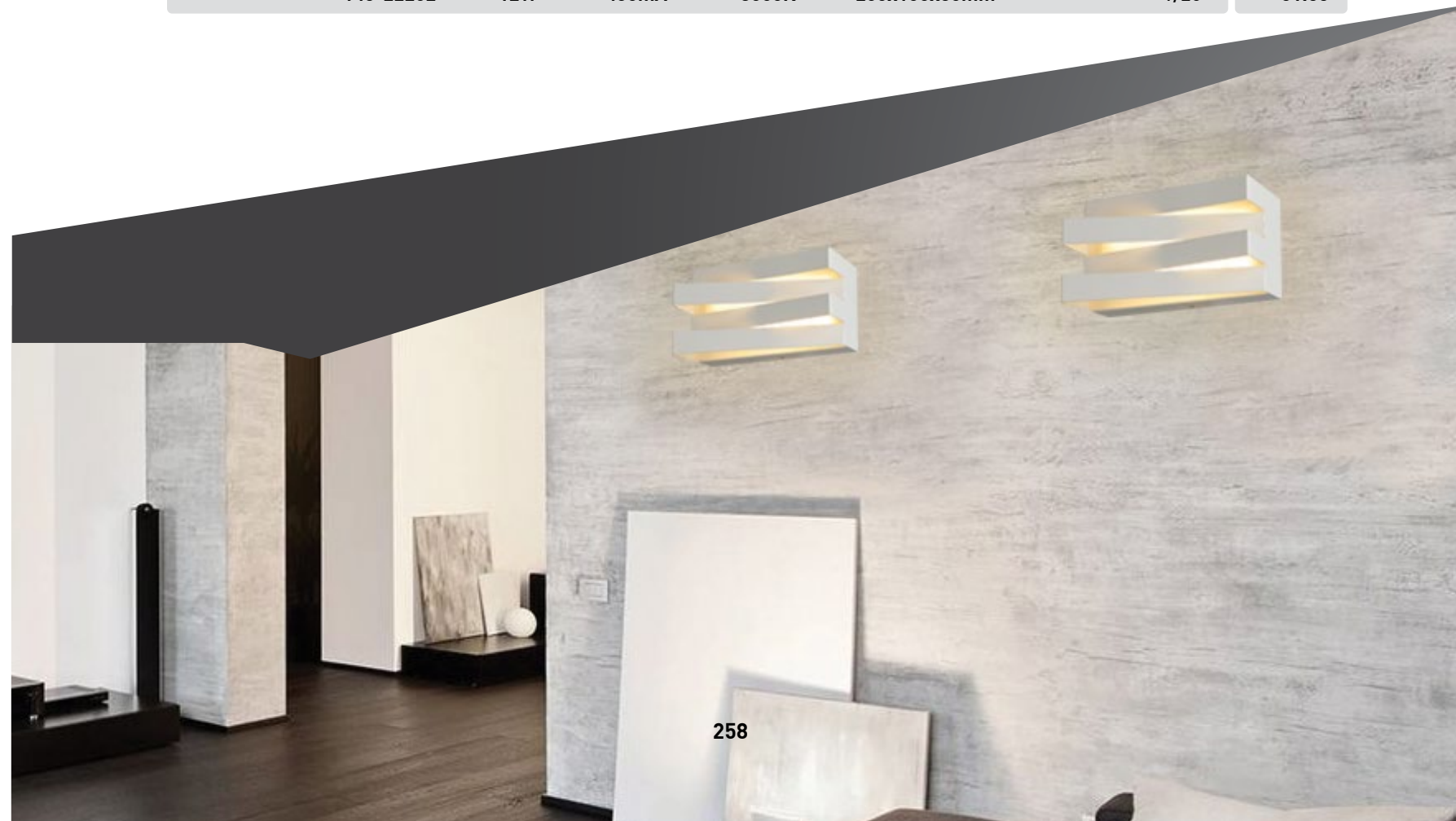

Φωτιστικά Εσωτερικού Χώρου

Indoor Lighting

Ιδανικοί για χρήση σε χώρους όπως:

- Κατοικίες
- Καταστήματα
- Εμπορικά Κέντρα
- Αποθήκες
- Βιοτεχνικούς Χώρους
- Βιομηχανικούς Χώρους
- Μοτέλ
- Ξενοδοχεία
- Αίθουσες Διδασκαλίας
- Εκθεσιακούς Χώρους
- Μουσεία
- Αρχιτεκτονικές Δομές
- Δημόσιες Εγκαταστάσεις

Ideal for use in places as:

- Residences
- Stores
- Shopping Malls
- Warehouses
- Business Areas
- Industrial Areas
- Motels
- Hotels
- Teaching Rooms
- Exhibitions
- Museums
- Architectural Structures
- Public Facilities

WALL MOUNTED LED FIXTURES • ΑΠΛΙΚΕΣ ΤΟΙΧΟΥ LED

PRODUCTION MATERIAL: **IRON & GLASS**  
ΥΛΙΚΟ ΚΑΤΑΣΚΕΥΗΣ: **ΣΙΔΗΡΟΣ & ΓΥΑΛΙ**

ERIS



145-22410

145-22411

145-22412

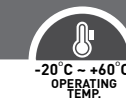

| BARCODE       | CODE      | BASE    | DIMENSIONS   | WEIGHT   | COLOR        | PACKING | PRICE (€) |
|---------------|-----------|---------|--------------|----------|--------------|---------|-----------|
| 5207227073328 | 145-22410 | 1 x E27 | 300x90x160mm | 0.850 kg | WHITE/NICKEL | 1/20    | 21.60     |
| 5207227073335 | 145-22411 | 1 x E27 | ∅300x90mm    | 1.400 kg | WHITE/NICKEL | 1/10    | 29.10     |
| 5207227073342 | 145-22412 | 2 x E27 | ∅400x90mm    | 2.730 kg | WHITE/NICKEL | 1/1     | 49.60     |

WALL MOUNTED LED FIXTURES • ΑΠΛΙΚΕΣ ΤΟΙΧΟΥ LED

PRODUCTION MATERIAL: **IRON & GLASS**  
ΥΛΙΚΟ ΚΑΤΑΣΚΕΥΗΣ: **ΣΙΔΗΡΟΣ & ΓΥΑΛΙ**

LEIA



145-22400

145-22401

145-22402



| BARCODE       | CODE      | BASE    | DIMENSIONS   | WEIGHT   | COLOR        | PACKING | PRICE (€) |
|---------------|-----------|---------|--------------|----------|--------------|---------|-----------|
| 5207227073267 | 145-22400 | 1 x E27 | 300x90x160mm | 0.625 kg | WHITE/NICKEL | 1/20    | 22.60     |
| 5207227073274 | 145-22401 | 1 x E27 | ∅300x90mm    | 1.150 kg | WHITE/NICKEL | 1/10    | 29.80     |
| 5207227073281 | 145-22402 | 2 x E27 | ∅400x90mm    | 2.285 kg | WHITE/NICKEL | 1/20    | 37.60     |

PRODUCTION MATERIAL: **IRON & GLASS**  
ΥΛΙΚΟ ΚΑΤΑΣΚΕΥΗΣ: **ΣΙΔΗΡΟΣ & ΓΥΑΛΙ**

ERIS



145-22413

145-22414

145-22415

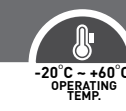
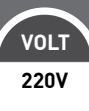

| BARCODE       | CODE      | BASE    | DIMENSIONS   | WEIGHT   | COLOR        | PACKING | PRICE (€) |
|---------------|-----------|---------|--------------|----------|--------------|---------|-----------|
| 5207227073359 | 145-22413 | 1 x E27 | 300x90x160mm | 0.850 kg | HONEY/BRONZE | 1/20    | 21.60     |
| 5207227073366 | 145-22414 | 1 x E27 | ∅300x90mm    | 1.400 kg | HONEY/BRONZE | 1/10    | 29.10     |
| 5207227073373 | 145-22415 | 2 x E27 | ∅400x90mm    | 2.730 kg | HONEY/BRONZE | 1/1     | 49.60     |

PRODUCTION MATERIAL: **IRON & GLASS**  
ΥΛΙΚΟ ΚΑΤΑΣΚΕΥΗΣ: **ΣΙΔΗΡΟΣ & ΓΥΑΛΙ**

PAROS



145-22403

145-22404

145-22405

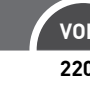

| BARCODE       | CODE      | BASE    | DIMENSIONS   | WEIGHT   | COLOR        | PACKING | PRICE (€) |
|---------------|-----------|---------|--------------|----------|--------------|---------|-----------|
| 5207227073298 | 145-22403 | 1 x E27 | 300x160x90mm | 0.950 kg | WHITE/NICKEL | 1/20    | 21.85     |
| 5207227073304 | 145-22404 | 1 x E27 | ∅300x90mm    | 1.150 kg | WHITE/NICKEL | 1/10    | 29.70     |
| 5207227073311 | 145-22405 | 2 x E27 | ∅400x90mm    | 2.285 kg | WHITE/NICKEL | 1/20    | 36.80     |

GLASS FOR HANGING LIGHTS • ΓΥΑΛΙΑ ΓΙΑ ΦΩΤΙΣΤΙΚΑ ΟΡΟΦΗΣ ΚΡΕΜΑΣΤΑ

PRODUCTION MATERIAL: **GLASS**  
ΥΛΙΚΟ ΚΑΤΑΣΚΕΥΗΣ: **ΓΥΑΛΙ**

TINA

**NEW!**



Nylon Bag  
with Sticker  
PACKING

| BARCODE       | CODE      | DIMENSIONS | WEIGHT   | COLOR | PACKING | PRICE (€) |
|---------------|-----------|------------|----------|-------|---------|-----------|
| 5207227073397 | 145-23200 | ∅30x130mm  | 1.262 kg | WHITE | 4*      | 16.85     |
| 5207227073403 | 145-23201 | ∅40x140mm  | 2.015 kg | WHITE | 3*      | 31.20     |
| 5207227073410 | 145-23202 | ∅30x130mm  | 1.262 kg | HONEY | 4*      | 16.85     |
| 5207227073427 | 145-23203 | ∅40x140mm  | 2.015 kg | HONEY | 3*      | 31.20     |

\* Υποχρεωτική Ποσότητα Κιβωτίου

\* Mandatory Quantity of Carton Box

**NEW!**



Nylon Bag  
with Sticker  
PACKING

| BARCODE       | CODE      | DIMENSIONS | WEIGHT   | COLOR | PACKING | PRICE (€) |
|---------------|-----------|------------|----------|-------|---------|-----------|
| 5207227073434 | 145-23204 | ∅35x140mm  | 1.362 kg | WHITE | 6*      | 24.80     |
| 5207227073441 | 145-23205 | ∅45x160mm  | 2.615 kg | WHITE | 3*      | 46.40     |
| 5207227073458 | 145-23206 | ∅35x140mm  | 1.362 kg | HONEY | 6*      | 24.80     |
| 5207227073465 | 145-23207 | ∅45x160mm  | 2.615 kg | HONEY | 3*      | 46.40     |

\* Υποχρεωτική Ποσότητα Κιβωτίου

\* Mandatory Quantity of Carton Box

HANGING LIGHTS • ΦΩΤΙΣΤΙΚΑ ΟΡΟΦΗΣ ΚΡΕΜΑΣΤΑ

PRODUCTION MATERIAL: **WOOD & METAL**

ΥΛΙΚΟ ΚΑΤΑΣΚΕΥΗΣ: **ΞΥΛΟ & ΜΕΤΑΛΛΟ**

NOSTOS

**NEW!**

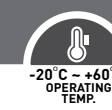
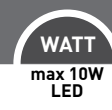

Carton Box  
with Sticker  
PACKING

| BARCODE       | CODE      | BASE    | DIMENSIONS   | WEIGHT   | COLOR                | PACKING | PRICE (€) |
|---------------|-----------|---------|--------------|----------|----------------------|---------|-----------|
| 5207227073472 | 145-23801 | 1 x E27 | 250x90x700mm | 1.500 kg | BLACK & NATURAL WOOD | 1/1     | 79.80     |
| 5207227073489 | 145-23802 | 2 x E27 | 400x90x700mm | 2.000 kg | BLACK & NATURAL WOOD | 1/1     | 147.00    |
| 5207227073496 | 145-23803 | 3 x E27 | 550x90x700mm | 3.000 kg | BLACK & NATURAL WOOD | 1/1     | 183.50    |

PRODUCTION MATERIAL: **WOOD & METAL**

ΥΛΙΚΟ ΚΑΤΑΣΚΕΥΗΣ: **ΞΥΛΟ & ΜΕΤΑΛΛΟ**

OREON

**NEW!**

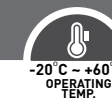
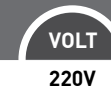

Carton Box  
with Sticker  
PACKING

| BARCODE       | CODE      | BASE    | DIMENSIONS    | WEIGHT   | COLOR                | PACKING | PRICE (€) |
|---------------|-----------|---------|---------------|----------|----------------------|---------|-----------|
| 5207227073502 | 145-23804 | 1 x E27 | 170x170x320mm | 0.500 kg | BLACK & NATURAL WOOD | 1/1     | 76.20     |
| 5207227073519 | 145-23805 | 1 x E27 | 170x170x700mm | 0.500 kg | BLACK & NATURAL WOOD | 1/1     | 78.40     |
| 5207227073526 | 145-23806 | 3 x E27 | 150x550x700mm | 4.500 kg | BLACK & NATURAL WOOD | 1/1     | 234.00    |

LAMPHOLDER • ΝΤΟΥΙ & ΡΟΖΕΤΕΣ

PRODUCTION MATERIAL: **METALLIC, PLASTIC & COPPER**  
ΥΛΙΚΟ ΚΑΤΑΣΚΕΥΗΣ: **ΜΕΤΑΛΛΟ, ΠΛΑΣΤΙΚΟ & ΧΑΛΚΟΣ**



145-23150



145-23151



145-23152



145-23153

ø10x1000mm

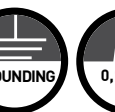
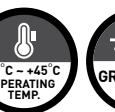
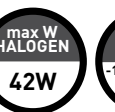
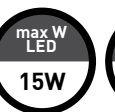

| Barcode       | Model     | Description  | Quantity | Price (€) |
|---------------|-----------|--|----------|-----------|
| 5207227055645 | 147-23150 | LAMPHOLDER IRON CUP PLATE NICKEL WITH CABLE GREEN-BEIGE FULL ΝΤΟΥΙ ΡΟΖΕΤΑ ΝΙΚΕΛ ΜΕ ΚΑΛΩΔΙΟ ΠΡΑΣΙΝΟ-ΜΠΕΖ ΠΛΗΡΕΣ | 1/50     | 15.65     |
| 5207227055652 | 147-23151 | LAMPHOLDER IRON CUP PLATE NICKEL WITH CABLE RED-GREY FULL ΝΤΟΥΙ ΡΟΖΕΤΑ ΝΙΚΕΛ ΜΕ ΚΑΛΩΔΙΟ ΚΟΚΚΙΝΟ-ΓΚΡΙ ΠΛΗΡΕΣ    | 1/50     | 15.65     |
| 5207227055669 | 147-23152 | LAMPHOLDER IRON CUP PLATE BLACK WITH CABLE WHITE-BLACK FULL ΝΤΟΥΙ ΡΟΖΕΤΑ ΜΑΥΡΗ ΜΕ ΚΑΛΩΔΙΟ ΑΣΠΡΟ-ΜΑΥΡΟ ΠΛΗΡΕΣ   | 1/50     | 15.65     |
| 5207227055676 | 147-23153 | LAMPHOLDER IRON CUP PLATE BLACK WITH CABLE GREY-WHITE FULL ΝΤΟΥΙ ΡΟΖΕΤΑ ΜΑΥΡΗ ΜΕ ΚΑΛΩΔΙΟ ΓΚΡΙ-ΑΣΠΡΟ ΠΛΗΡΕΣ     | 1/50     | 15.65     |

HANGING LIGHTS / LAMPSHADE • ΦΩΤΙΣΤΙΚΑ ΟΡΟΦΗΣ ΚΡΕΜΑΣΤΑ / ΣΚΙΑΔΕΣ

PRODUCTION MATERIAL: **METALLIC**  
ΥΛΙΚΟ ΚΑΤΑΣΚΕΥΗΣ: **ΜΕΤΑΛΛΙΚΟ**

SYROS



153-56200



153-56202



153-56204



| Barcode       | Code      | Dimensions | Weight   | Color     | Packing | Price (€) |
|---------------|-----------|------------|----------|-----------|---------|-----------|
| 5206139073969 | 153-56200 | ø300x50mm  | 0,401 kg | BLACK     | 1/20    | 13.15     |
| 5206139073976 | 153-56201 | ø300x50mm  | 0,457 kg | SILVER    | 1/20    | 14.65     |
| 5206139073983 | 153-56202 | ø360x160mm | 0,700kg  | BLACK     | 1/20    | 25.35     |
| 5206139074003 | 153-56203 | ø360x160mm | 0,700kg  | BRONZE    | 1/20    | 26.55     |
| 5206139074010 | 153-56204 | ø360x100mm | 0,627 kg | WHITE MAT | 1/20    | 15.60     |
| 5206139074027 | 153-56205 | ø360x100mm | 0,610 kg | BLACK MAT | 1/20    | 15.60     |

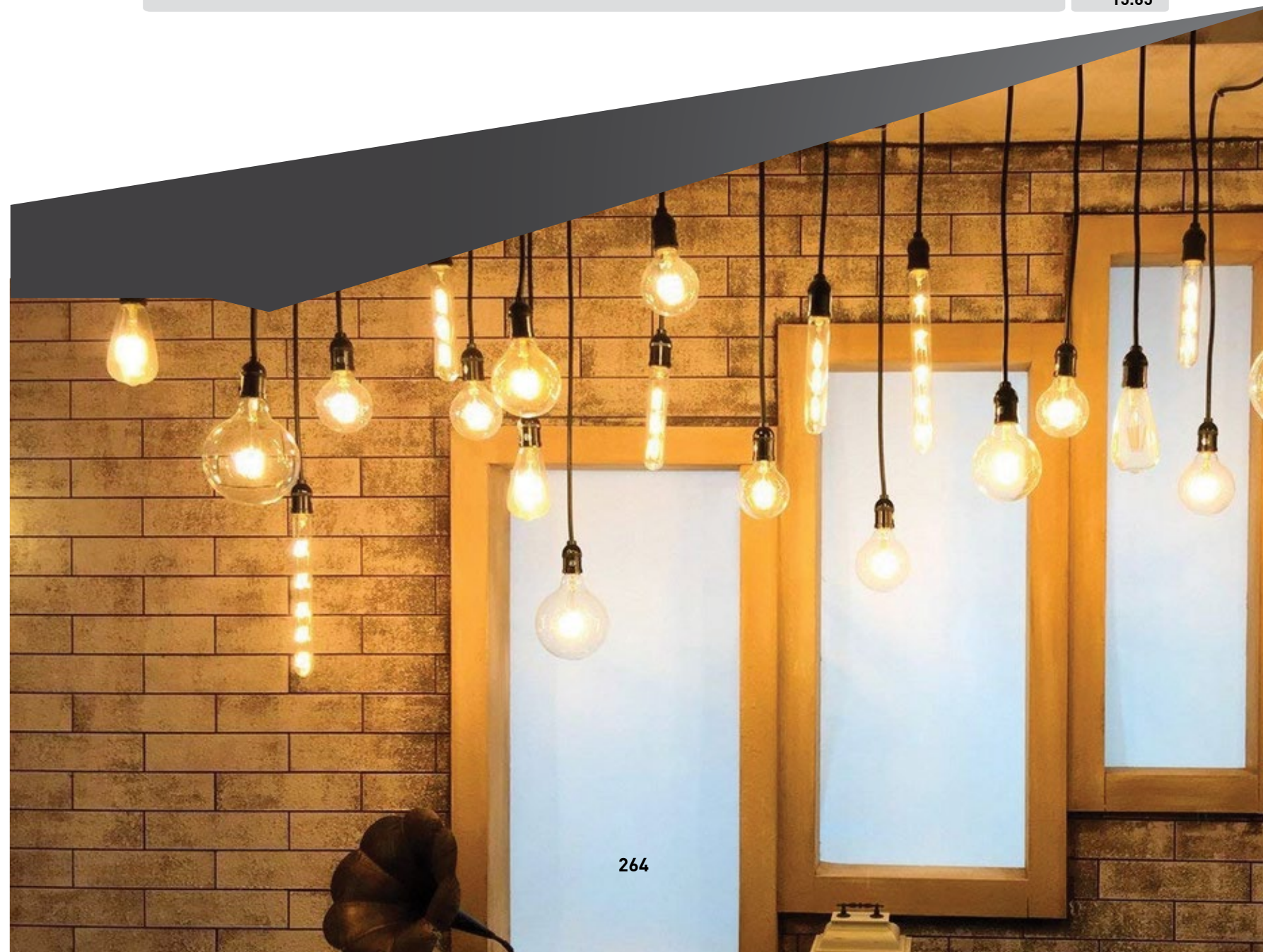

LED DESK LAMP • ΦΩΤΙΣΤΙΚΑ ΓΡΑΦΕΙΟΥ LED

PRODUCTION MATERIAL: **PLASTIC & STEEL**  
ΥΛΙΚΟ ΚΑΤΑΣΚΕΥΗΣ: **ΠΛΑΣΤΙΚΟ & ΑΤΣΑΛΙ**

3 Step Dimming / 3 Επιλογές Έντασης Φωτός:  
100%, 50%, 20%, OFF



| BARCODE       | CODE      | WATT | AMPERAGE | KELVIN | DIMENSIONS    | COLOR | PACKING | PRICE (€) |  |
|---------------|-----------|------|----------|--------|---------------|-------|---------|-----------|--|
| 5206139049094 | 147-55406 | 6W   | 120mA    | 4000K  | 381x115x308mm | BLACK | 1/10    | 36.60     |  |
| 5206139049117 | 147-55407 | 6W   | 120mA    | 4000K  | 381x115x308mm | WHITE | 1/10    | 36.60     |  |



LED DESK LAMP • ΦΩΤΙΣΤΙΚΑ ΓΡΑΦΕΙΟΥ LED

PRODUCTION MATERIAL: **ALUMINIUM & IRON**  
ΥΛΙΚΟ ΚΑΤΑΣΚΕΥΗΣ: **ΑΛΟΥΜΙΝΙΟ & ΣΙΔΗΡΟΣ**

ARISTON 6



| BARCODE       | CODE      | WATT | AMPERAGE | KELVIN | DIMENSIONS   | COLOR | PACKING | PRICE (€) |
|---------------|-----------|------|----------|--------|--------------|-------|---------|-----------|
| 5207227070006 | 147-55472 | 3W   | 600mA    | 3000K  | 100x55x390mm | WHITE | 1/30    | 39.85     |
| 5207227070020 | 147-55473 | 3W   | 600mA    | 3000K  | 100x55x390mm | BLACK | 1/30    | 39.85     |



White Box with Sticker PACKING

PRODUCTION MATERIAL: **ABS**  
ΥΛΙΚΟ ΚΑΤΑΣΚΕΥΗΣ: **ABS**

Charging Time 2 hrs  
Χρόνος Φόρτισης 2 ώρες  
Battery: Lithium 500mAh



| BARCODE       | CODE      | WATT | KELVIN | DIMENSIONS    | COLOR | PACKING | PRICE (€) |  |  |  |
|---------------|-----------|------|--------|---------------|-------|---------|-----------|--|--|--|
| 5207227028793 | 147-55470 | 1,5W | 6000K  | 310x120x100mm | WHITE | 1/32    | 19.25     |  |  |  |



Color Box PACKING

PRODUCTION MATERIAL: **ALUMINIUM & IRON**  
ΥΛΙΚΟ ΚΑΤΑΣΚΕΥΗΣ: **ΑΛΟΥΜΙΝΙΟ & ΣΙΔΗΡΟΣ**

ARISTON 7



| BARCODE       | CODE      | WATT | AMPERAGE | KELVIN | DIMENSIONS   | COLOR | PACKING | PRICE (€) |
|---------------|-----------|------|----------|--------|--------------|-------|---------|-----------|
| 5207227070037 | 147-55474 | 3W   | 600mA    | 3000K  | 100x80x370mm | WHITE | 1/30    | 39.85     |
| 5207227070051 | 147-55475 | 3W   | 600mA    | 3000K  | 100x80x370mm | BLACK | 1/30    | 39.85     |



White Box with Sticker PACKING

PRODUCTION MATERIAL: **ABS**  
ΥΛΙΚΟ ΚΑΤΑΣΚΕΥΗΣ: **ABS**

Charging Time 2 hrs  
Χρόνος Φόρτισης 2 ώρες  
Battery: Lithium 500mAh



| BARCODE       | CODE      | WATT | KELVIN | DIMENSIONS    | COLOR | PACKING | PRICE (€) |  |  |  |
|---------------|-----------|------|--------|---------------|-------|---------|-----------|--|--|--|
| 5207227028809 | 147-55471 | 1,5W | 6000K  | 380x180x105mm | WHITE | 1/45    | 24.20     |  |  |  |



Color Box PACKING



LED DESK LAMP • ΦΩΤΙΣΤΙΚΑ ΓΡΑΦΕΙΟΥ LED



PRODUCTION MATERIAL: **METALLIC & PLASTIC**  
ΥΛΙΚΟ ΚΑΤΑΣΚΕΥΗΣ: **ΜΕΤΑΛΛΟ & ΠΛΑΣΤΙΚΟ**

Function duration 4-8 hrs  
Διάρκεια χρήσης 4-8 ώρες

| BARCODE       | CODE      | WATT | DIMENSIONS   | COLOR | PACKING | PRICE (€) |  |
|---------------|-----------|------|--------------|-------|---------|-----------|--|
| 5206139019097 | 147-55410 | 3W   | 70x145x300mm | WHITE | 1/20    | 29.90     |  |

DESK LAMP • ΦΩΤΙΣΤΙΚΑ ΓΡΑΦΕΙΟΥ



PRODUCTION MATERIAL: **PLASTIC & STEEL**  
ΥΛΙΚΟ ΚΑΤΑΣΚΕΥΗΣ: **ΠΛΑΣΤΙΚΟ & ΑΤΣΑΛΙ**

3 Επιλογές Έντασης Φωτός  
3 Step Dimming

| BARCODE       | CODE      | WATT                   | DIMENSIONS | COLOR | PACKING | PRICE (€) |
|---------------|-----------|------------------------|------------|-------|---------|-----------|
| 5206139050175 | 147-55440 | max 7W LED/25W halogen | φ150x400mm | BLACK | 1/20    | 22.25     |

PRODUCTION MATERIAL: **METAL, PLASTIC & FABRIC**  
ΥΛΙΚΟ ΚΑΤΑΣΚΕΥΗΣ: **ΜΕΤΑΛΛΟ, ΠΛΑΣΤΙΚΟ & ΥΦΑΣΜΑ**



3 Επιλογές Έντασης Φωτός  
3 Step Dimming

Base for Fragrance Oil  
Βάση για Αρωματικό Έλαιο

| BARCODE       | CODE      | WATT                   | DIMENSIONS | COLOR          | PACKING | PRICE (€) |  |
|---------------|-----------|------------------------|------------|----------------|---------|-----------|--|
| 5206139061072 | 153-53000 | max 7W LED/28W halogen | φ150x280mm | NICKEL - BLACK | 1/12    | 26.95     |  |
| 5206139061096 | 153-53001 | max 7W LED/28W halogen | φ150x280mm | NICKEL - WHITE | 1/12    | 26.95     |  |



Φωτιστικά Εξωτερικού Χώρου

για Οικιακή & Επαγγελματική Χρήση

Outdoor Lighting Fixtures

for Domestic & Professional use

Ιδανικοί για χρήση σε χώρους όπως:

- Κατοικίες
- Καταστήματα
- Εμπορικά Κέντρα
- Αποθήκες
- Βιοτεχνικούς Χώρους
- Βιομηχανικούς Χώρους
- Μοτέλ
- Ξενοδοχεία
- Αίθουσες Διδασκαλίας
- Εκθεσιακούς Χώρους
- Μουσεία
- Αρχιτεκτονικές Δομές
- Δημόσιες Εγκαταστάσεις



















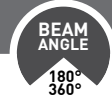

Ideal for use in places as:

- Residences
- Stores
- Shopping Malls
- Warehouses
- Business Areas
- Industrial Areas
- Motels
- Hotels
- Teaching Rooms
- Exhibitions
- Museums
- Architectural Structures
- Public Facilities

LED CEILING LIGHT WITH MOTION SENSOR • ΠΛΑΦΟΝΙΕΡΑ LED ΜΕ ΑΝΙΧΝΕΥΤΗ ΚΙΝΗΣΗΣ

PRODUCTION MATERIAL: **PMMA & IRON**  
ΥΛΙΚΟ ΚΑΤΑΣΚΕΥΗΣ: **PMMA & ΣΙΔΗΡΟΣ**















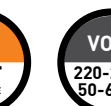
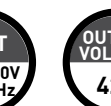





Detection distance / wall: max 15mtr / ceiling: 2mtr - 8mtr  
Stand-by Dimming level: 20% / Detector Day-Night: less 50LUX Delay Time: 3sec to 12min

| BARCODE       | CODE      | WATT | AMPERAGE | KELVIN | DIMENSIONS | COLOR | PACKING | PRICE (€) |
|---------------|-----------|------|----------|--------|------------|-------|---------|-----------|
| 5206139080882 | 145-55300 | 21W  | 600mA    | 4000K  | ø295x95mm  | WHITE | 1/5     | 54.90     |

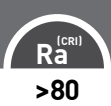
PRODUCTION MATERIAL: **PLASTIC (UV PROOF)**  
ΥΛΙΚΟ ΚΑΤΑΣΚΕΥΗΣ: **ΠΛΑΣΤΙΚΟ (UV PROOF)**









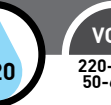
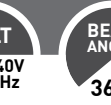

Detection distance wall: max 15mtr / ceiling: 2mtr - 8mtr  
Delay Time: 3sec to 12min

| BARCODE       | CODE      | WATT | AMPERAGE | KELVIN | DIMENSIONS | COLOR | PACKING | PRICE (€) |
|---------------|-----------|------|----------|--------|------------|-------|---------|-----------|
| 5206139080899 | 145-55301 | 16W  | 300mA    | 4000K  | ø300x87mm  | WHITE | 1/5     | 54.60     |

PRODUCTION MATERIAL: **PMMA & IRON**  
ΥΛΙΚΟ ΚΑΤΑΣΚΕΥΗΣ: **PMMA & ΣΙΔΗΡΟΣ**















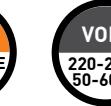



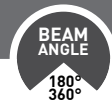

Detection distance 1mtr - 8mtr  
Delay Time: 3sec to 12min

| BARCODE       | CODE      | WATT                   | DIMENSIONS   | COLOR | PACKING | PRICE (€) |
|---------------|-----------|------------------------|--------------|-------|---------|-----------|
| 5206139080936 | 145-55304 | max 8W LED/28W halogen | ø270x103.4mm | WHITE | 1/5     | 36.05     |

PRODUCTION MATERIAL: **PLASTIC (UV PROOF)**  
ΥΛΙΚΟ ΚΑΤΑΣΚΕΥΗΣ: **ΠΛΑΣΤΙΚΟ (UV PROOF)**





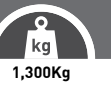











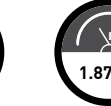

Detection distance wall: max 15mtr / ceiling: 2mtr - 8mtr  
Delay Time: 3sec to 12min

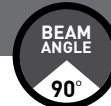
| BARCODE       | CODE      | WATT | AMPERAGE | KELVIN | DIMENSIONS | COLOR | PACKING | PRICE (€) |
|---------------|-----------|------|----------|--------|------------|-------|---------|-----------|
| 5207227021237 | 145-55305 | 16W  | 300mA    | 3000K  | ø300x87mm  | WHITE | 1/5     | 56.65     |

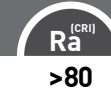
SWIMMING POOL LED LIGHTS • ΦΩΤΙΣΤΙΚΑ ΠΙΣΙΝΑΣ LED

PRODUCTION MATERIAL: **ABS & PLASTIC**  
ΥΛΙΚΟ ΚΑΤΑΣΚΕΥΗΣ: **ABS & ΠΛΑΣΤΙΚΟ**























| BARCODE       | CODE       | WATT | KELVIN | DIMENSIONS | COLOR | PACKING | PRICE (€) |
|---------------|------------|------|--------|------------|-------|---------|-----------|
| 5206139047595 | 145-55900* | 18W  | 6500K  | ø230x58mm  | WHITE | 1/10    | 129.00    |
| 5206139047618 | 145-55901  | 18W  | BLUE   | ø230x58mm  | WHITE | 1/10    | 129.00    |
| 5206139047632 | 145-55902  | 18W  | RGB    | ø230x58mm  | WHITE | 1/10    | 158.00    |
| 5207227059872 | 145-55904* | 18W  | 3000K  | ø230x58mm  | WHITE | 1/10    | 129.00    |

UNDERWATER LIGHT • ΣΠΟΤ ΣΥΝΤΡΙΒΑΝΙΟΥ

PRODUCTION MATERIAL: **STAINLESS STEEL**  
ΥΛΙΚΟ ΚΑΤΑΣΚΕΥΗΣ: **ΑΝΟΞΕΙΔΩΤΟ ΑΤΣΑΛΙ**

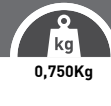

| BARCODE       | CODE      | WATT                   | DIMENSIONS | COLOR | PACKING | PRICE (€) |
|---------------|-----------|------------------------|------------|-------|---------|-----------|
| 5207227014055 | 147-68415 | max 7W LED/33W halogen | ø95x145mm  | STEEL | 1/20    | 36.85     |

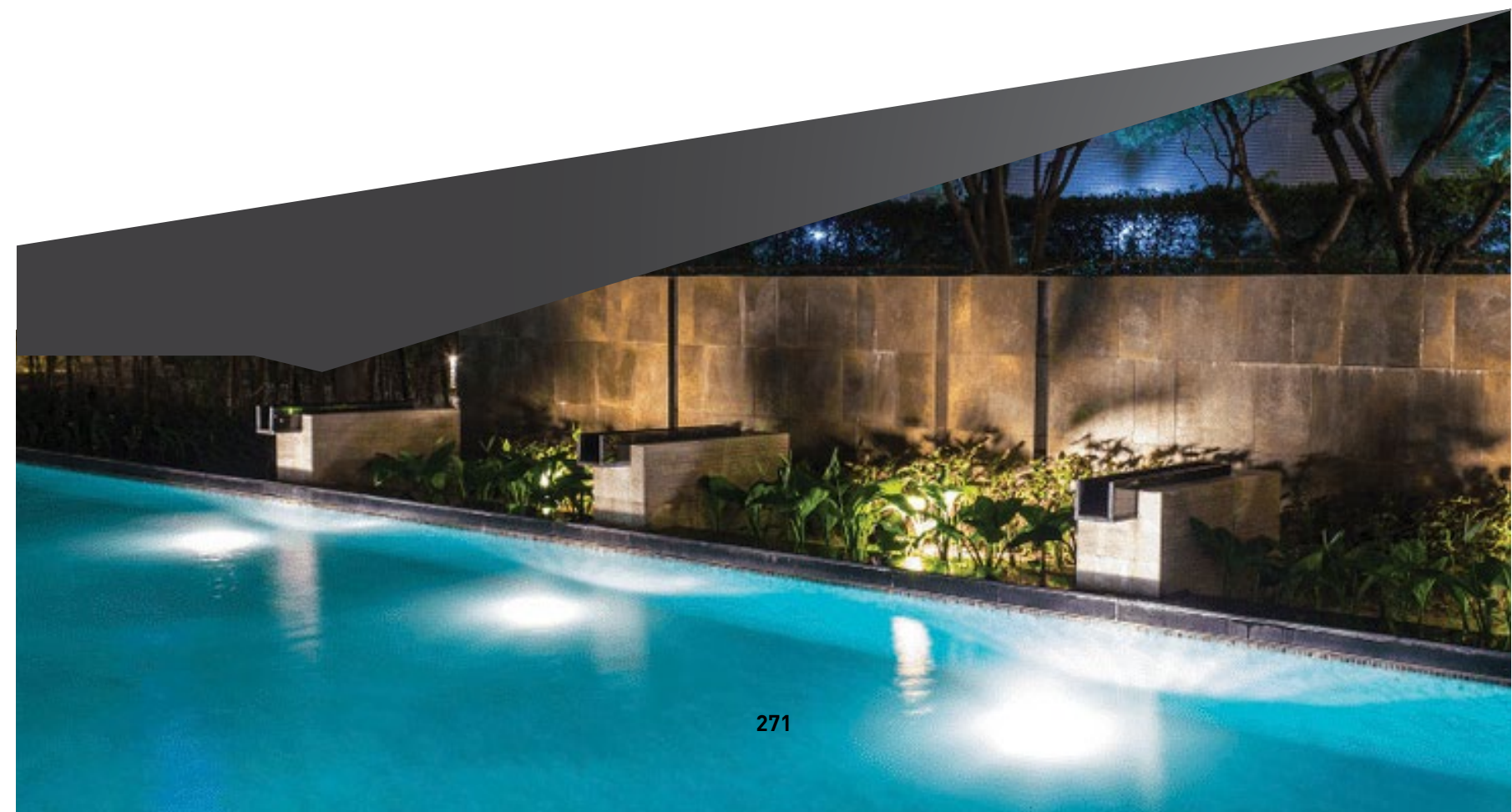

WALL MOUNTED LED FIXTURES • ΦΩΤΙΣΤΙΚΑ ΤΟΙΧΟΥ LED

PRODUCTION MATERIAL: ABS & PLASTIC  
ΥΛΙΚΟ ΚΑΤΑΣΚΕΥΗΣ: ABS & ΠΛΑΣΤΙΚΟ



| BARCODE       | CODE      | WATT | AMPERAGE | KELVIN | DIMENSIONS  | COLOR     | PACKING | PRICE (€) |
|---------------|-----------|------|----------|--------|-------------|-----------|---------|-----------|
| 5207227014543 | 145-52000 | 3W   | 31mA     | 3000K  | 200x80x27mm | WHITE     | 1/20    | 28.80     |
| 5207227014574 | 145-52001 | 3W   | 31mA     | 3000K  | 200x80x27mm | BLACK     | 1/20    | 28.80     |
| 5207227014604 | 145-52002 | 3W   | 31mA     | 3000K  | 200x80x27mm | GREY      | 1/20    | 28.80     |
| 5207227014635 | 145-52003 | 3W   | 31mA     | 3000K  | 200x80x27mm | DARK GREY | 1/20    | 28.80     |



PRODUCTION MATERIAL: ABS & PLASTIC  
ΥΛΙΚΟ ΚΑΤΑΣΚΕΥΗΣ: ABS & ΠΛΑΣΤΙΚΟ

| BARCODE       | CODE      | WATT | AMPERAGE | KELVIN | DIMENSIONS   | COLOR     | PACKING | PRICE (€) |
|---------------|-----------|------|----------|--------|--------------|-----------|---------|-----------|
| 5207227014666 | 145-52004 | 3W   | 28mA     | 3000K  | 125x125x27mm | WHITE     | 1/20    | 26.60     |
| 5207227014697 | 145-52005 | 3W   | 28mA     | 3000K  | 125x125x27mm | BLACK     | 1/20    | 26.60     |
| 5207227014727 | 145-52006 | 3W   | 28mA     | 3000K  | 125x125x27mm | GREY      | 1/20    | 26.60     |
| 5207227014758 | 145-52007 | 3W   | 28mA     | 3000K  | 125x125x27mm | DARK GREY | 1/20    | 26.60     |



PRODUCTION MATERIAL: ABS & PLASTIC  
ΥΛΙΚΟ ΚΑΤΑΣΚΕΥΗΣ: ABS & ΠΛΑΣΤΙΚΟ

| BARCODE       | CODE      | WATT | AMPERAGE | KELVIN | DIMENSIONS  | COLOR     | PACKING | PRICE (€) |
|---------------|-----------|------|----------|--------|-------------|-----------|---------|-----------|
| 5207227014789 | 145-52010 | 3W   | 33mA     | 3000K  | 160x70x33mm | WHITE     | 1/20    | 24.85     |
| 5207227014819 | 145-52012 | 3W   | 33mA     | 3000K  | 160x70x33mm | GREY      | 1/20    | 24.85     |
| 5207227014840 | 145-52013 | 3W   | 33mA     | 3000K  | 160x70x33mm | DARK GREY | 1/20    | 24.85     |

WALL MOUNTED LED FIXTURES • ΦΩΤΙΣΤΙΚΑ ΤΟΙΧΟΥ LED

PRODUCTION MATERIAL: ABS & PLASTIC  
ΥΛΙΚΟ ΚΑΤΑΣΚΕΥΗΣ: ABS & ΠΛΑΣΤΙΚΟ



| BARCODE       | CODE      | WATT | AMPERAGE | KELVIN | DIMENSIONS | COLOR     | PACKING | PRICE (€) |
|---------------|-----------|------|----------|--------|------------|-----------|---------|-----------|
| 5207227014871 | 145-52014 | 3W   | 30mA     | 3000K  | ø135x32mm  | WHITE     | 1/40    | 21.80     |
| 5207227014901 | 145-52015 | 3W   | 30mA     | 3000K  | ø135x32mm  | GREY      | 1/40    | 21.80     |
| 5207227014932 | 145-52016 | 3W   | 30mA     | 3000K  | ø135x32mm  | DARK GREY | 1/40    | 21.80     |



PRODUCTION MATERIAL: ABS & PLASTIC  
ΥΛΙΚΟ ΚΑΤΑΣΚΕΥΗΣ: ABS & ΠΛΑΣΤΙΚΟ

| BARCODE       | CODE      | WATT | AMPERAGE | KELVIN | DIMENSIONS   | COLOR     | PACKING | PRICE (€) |
|---------------|-----------|------|----------|--------|--------------|-----------|---------|-----------|
| 5207227014963 | 145-52017 | 3W   | 30mA     | 3000K  | 120x120x21mm | WHITE     | 1/40    | 21.80     |
| 5207227014994 | 145-52019 | 3W   | 30mA     | 3000K  | 120x120x21mm | GREY      | 1/40    | 21.80     |
| 5207227015021 | 145-52020 | 3W   | 30mA     | 3000K  | 120x120x21mm | DARK GREY | 1/40    | 21.80     |



PRODUCTION MATERIAL: ABS & PLASTIC  
ΥΛΙΚΟ ΚΑΤΑΣΚΕΥΗΣ: ABS & ΠΛΑΣΤΙΚΟ

| BARCODE       | CODE      | WATT | AMPERAGE | KELVIN | DIMENSIONS  | COLOR     | PACKING | PRICE (€) |
|---------------|-----------|------|----------|--------|-------------|-----------|---------|-----------|
| 5207227015052 | 145-52021 | 3W   | 26mA     | 3000K  | 90x32x150mm | WHITE     | 1/40    | 21.80     |
| 5207227015083 | 145-52023 | 3W   | 26mA     | 3000K  | 90x32x150mm | GREY      | 1/40    | 21.80     |
| 5207227015113 | 145-52024 | 3W   | 26mA     | 3000K  | 90x32x150mm | DARK GREY | 1/40    | 21.80     |

WALL MOUNTED LED FIXTURES • ΦΩΤΙΣΤΙΚΑ ΤΟΙΧΟΥ LED

WALL MOUNTED LED FIXTURES • ΦΩΤΙΣΤΙΚΑ ΤΟΙΧΟΥ LED

**NEW!**

PRODUCTION MATERIAL: **PLASTIC**  
ΥΛΙΚΟ ΚΑΤΑΣΚΕΥΗΣ: ΠΛΑΣΤΙΚΟ



PLUS  
2 YEARS WARRANTY

Color Box PACKING

| IP65           | A ENERGY CLASS | VOLT 220-240V 50-60Hz | LUMENS 25/W | SMD 2835 | CLASS II     | 25°C ~ +50°C OPERATING TEMP. | 0,070Kg                 |           |
|----------------|----------------|-----------------------|-------------|----------|--------------|------------------------------|-------------------------|-----------|
| BEAM ANGLE 75° | Flicker free   | PF >0.5               | CR1 Ra >80  | IK 06    | 15000 ON-OFF | 20000h LIFE TIME             | START TIME min: 0.5 sec |           |
| BARCODE        | CODE           | WATT                  | AMPERAGE    | KELVIN   | DIMENSIONS   | COLOR                        | PACKING                 | PRICE (€) |
| 5207227062605  | 145-52100      | 2W                    | 18mA        | 3000K    | 90x120x12mm  | WHITE                        | 1/50                    | 14.35     |

**NEW!**

PRODUCTION MATERIAL: **PP & PLASTIC**  
ΥΛΙΚΟ ΚΑΤΑΣΚΕΥΗΣ: PP & ΠΛΑΣΤΙΚΟ



PLUS  
2 YEARS WARRANTY

Color Box PACKING

| IP54            | A ENERGY CLASS | VOLT 220-240V 50-60Hz | LUMENS 85/W | SMD 2835 | CLASS II     | 25°C ~ +45°C OPERATING TEMP. | 0,141Kg<br>0,162Kg*     |           |
|-----------------|----------------|-----------------------|-------------|----------|--------------|------------------------------|-------------------------|-----------|
| BEAM ANGLE 110° | Flicker free   | PF >0.5               | CR1 Ra >80  | IK 06    | 12500 ON-OFF | 25000h LIFE TIME             | START TIME min: 0.5 sec |           |
| BARCODE         | CODE           | WATT                  | AMPERAGE    | KELVIN   | DIMENSIONS   | COLOR                        | PACKING                 | PRICE (€) |
| 5207227063473   | 145-20010      | 8W                    | 80mA        | 4000K    | 160x90x51mm  | WHITE                        | 1/32                    | 9.45      |
| 5207227063497   | 145-20011      | 8W                    | 80mA        | 3000K    | 160x90x51mm  | WHITE                        | 1/32                    | 9.45      |
| 5207227063510   | 145-20012*     | 12W                   | 120mA       | 4000K    | 205x105x54mm | WHITE                        | 1/32                    | 12.30     |
| 5207227063534   | 145-20013*     | 12W                   | 120mA       | 3000K    | 205x105x54mm | WHITE                        | 1/32                    | 12.30     |

**NEW!**

PRODUCTION MATERIAL: **PLASTIC**  
ΥΛΙΚΟ ΚΑΤΑΣΚΕΥΗΣ: ΠΛΑΣΤΙΚΟ



PLUS  
2 YEARS WARRANTY

Color Box PACKING

| IP65           | A ENERGY CLASS | VOLT 220-240V 50-60Hz | LUMENS 25/W | SMD 2835 | CLASS II     | 25°C ~ +50°C OPERATING TEMP. | 0,080Kg                 |           |
|----------------|----------------|-----------------------|-------------|----------|--------------|------------------------------|-------------------------|-----------|
| BEAM ANGLE 75° | Flicker free   | PF >0.5               | CR1 Ra >80  | IK 06    | 15000 ON-OFF | 20000h LIFE TIME             | START TIME min: 0.5 sec |           |
| BARCODE        | CODE           | WATT                  | AMPERAGE    | KELVIN   | DIMENSIONS   | COLOR                        | PACKING                 | PRICE (€) |
| 5207227062629  | 145-52101      | 3W                    | 27mA        | 3000K    | 120x120x12mm | WHITE                        | 1/50                    | 16.85     |

**NEW!**

PRODUCTION MATERIAL: **PP & PLASTIC**  
ΥΛΙΚΟ ΚΑΤΑΣΚΕΥΗΣ: PP & ΠΛΑΣΤΙΚΟ



PLUS  
2 YEARS WARRANTY

Color Box PACKING

| IP54            | A ENERGY CLASS | VOLT 220-240V 50-60Hz | LUMENS 85/W | SMD 2835 | CLASS II     | 25°C ~ +45°C OPERATING TEMP. | 0,189Kg                 |           |
|-----------------|----------------|-----------------------|-------------|----------|--------------|------------------------------|-------------------------|-----------|
| BEAM ANGLE 110° | Flicker free   | PF >0.5               | CR1 Ra >80  | IK 06    | 12500 ON-OFF | 25000h LIFE TIME             | START TIME min: 0.5 sec |           |
| BARCODE         | CODE           | WATT                  | AMPERAGE    | KELVIN   | DIMENSIONS   | COLOR                        | PACKING                 | PRICE (€) |
| 5207227063558   | 145-20014      | 12W                   | 120mA       | 4000K    | ∅170x50mm    | WHITE                        | 1/20                    | 12.85     |
| 5207227063572   | 145-20015      | 12W                   | 120mA       | 3000K    | ∅170x50mm    | WHITE                        | 1/20                    | 12.85     |
| 5207227063596   | 145-20016      | 18W                   | 170mA       | 4000K    | ∅200x55mm    | WHITE                        | 1/20                    | 17.65     |
| 5207227063619   | 145-20017      | 18W                   | 170mA       | 3000K    | ∅200x55mm    | WHITE                        | 1/20                    | 17.65     |

**NEW!**

PRODUCTION MATERIAL: **PLASTIC**  
ΥΛΙΚΟ ΚΑΤΑΣΚΕΥΗΣ: ΠΛΑΣΤΙΚΟ



PLUS  
2 YEARS WARRANTY

Color Box PACKING

| IP65            | A ENERGY CLASS | VOLT 220-240V 50-60Hz | LUMENS 35/W | SMD 2835 | CLASS II     | 25°C ~ +50°C OPERATING TEMP. | 0,090Kg                 |           |
|-----------------|----------------|-----------------------|-------------|----------|--------------|------------------------------|-------------------------|-----------|
| BEAM ANGLE 115° | Flicker free   | PF >0.5               | CR1 Ra >80  | IK 06    | 15000 ON-OFF | 20000h LIFE TIME             | START TIME min: 0.5 sec |           |
| BARCODE         | CODE           | WATT                  | AMPERAGE    | KELVIN   | DIMENSIONS   | COLOR                        | PACKING                 | PRICE (€) |
| 5207227062643   | 145-52103      | 2W                    | 18mA        | 3000K    | 83x123x35mm  | WHITE                        | 1/50                    | 14.85     |

WALL MOUNTED LED FIXTURES • ΦΩΤΙΣΤΙΚΑ ΤΟΙΧΟΥ LED

WALL MOUNTED LED FIXTURES • ΦΩΤΙΣΤΙΚΑ ΤΟΙΧΟΥ LED

PRODUCTION MATERIAL: **PP & PLASTIC**  
ΥΛΙΚΟ ΚΑΤΑΣΚΕΥΗΣ: **PP & ΠΛΑΣΤΙΚΟ**

**NEW!**



PLUS

2 YEARS WARRANTY

Color Box PACKING

| IP65          | A ENERGY CLASS | VOLT 220-240V 50-60Hz | LUMENS 85/W | SMD 2835 | CLASS II     | 25°C - +45°C OPERATING TEMP. | 0,266Kg                 |           |
|---------------|----------------|-----------------------|-------------|----------|--------------|------------------------------|-------------------------|-----------|
| 110°          | Ticker free    | PF >0.5               | Ra >80      | IK 06    | 12500 ON-OFF | 25000h LIFE TIME             | START TIME min: 0.5 sec |           |
| BARCODE       | CODE           | WATT                  | AMPERAGE    | KELVIN   | DIMENSIONS   | COLOR                        | PACKING                 | PRICE (€) |
| 5207227063633 | 145-20018      | 11W                   | 110mA       | 4000K    | 190x113x42mm | WHITE                        | 1/24                    | 18.90     |
| 5207227063657 | 145-20019      | 11W                   | 110mA       | 3000K    | 190x113x42mm | WHITE                        | 1/24                    | 18.90     |

PRODUCTION MATERIAL: **ABS & PLASTIC**  
ΥΛΙΚΟ ΚΑΤΑΣΚΕΥΗΣ: **ABS & ΠΛΑΣΤΙΚΟ**



PRO

2 YEARS WARRANTY

White Box with Sticker PACKING

| IP65          | A ENERGY CLASS | VOLT 220-240V 50-60Hz | LUMENS 85/W | SMD 2835 | CLASS II      | 25°C - +45°C OPERATING TEMP. | 0,710Kg                 |           |
|---------------|----------------|-----------------------|-------------|----------|---------------|------------------------------|-------------------------|-----------|
| 120°          | Ticker free    | PF >0.8               | Ra >80      | IK 06    | 30000 ON-OFF  | 25000h LIFE TIME             | START TIME min: 0.5 sec |           |
| BARCODE       | CODE           | WATT                  | AMPERAGE    | KELVIN   | DIMENSIONS    | COLOR                        | PACKING                 | PRICE (€) |
| 5207227015502 | 145-52030      | 12W                   | 120mA       | 3000K    | 320x130x132mm | WHITE                        | 1/12                    | 62.45     |
| 5207227015533 | 145-52032      | 12W                   | 120mA       | 3000K    | 320x130x132mm | GREY                         | 1/12                    | 62.45     |

PRODUCTION MATERIAL: **ABS & PLASTIC**  
ΥΛΙΚΟ ΚΑΤΑΣΚΕΥΗΣ: **ABS & ΠΛΑΣΤΙΚΟ**

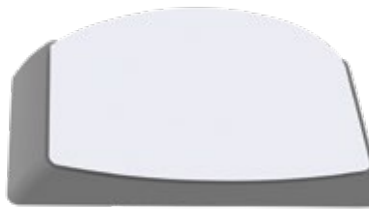

PRO

2 YEARS WARRANTY

White Box with Sticker PACKING

| IP65          | A+ ENERGY CLASS | VOLT 220-240V 50-60Hz | LUMENS 85/W | SMD 2835 | CLASS II      | 25°C - +45°C OPERATING TEMP. | 0,680Kg                 |           |
|---------------|-----------------|-----------------------|-------------|----------|---------------|------------------------------|-------------------------|-----------|
| 120°          | Ticker free     | PF >0.8               | Ra >80      | IK 06    | 30000 ON-OFF  | 25000h LIFE TIME             | START TIME min: 0.5 sec |           |
| BARCODE       | CODE            | WATT                  | AMPERAGE    | KELVIN   | DIMENSIONS    | COLOR                        | PACKING                 | PRICE (€) |
| 5207227015441 | 145-52025       | 12W                   | 120mA       | 3000K    | 320x130x129mm | WHITE                        | 1/12                    | 62.45     |
| 5207227015472 | 145-52027       | 12W                   | 120mA       | 3000K    | 320x130x129mm | GREY                         | 1/12                    | 62.45     |

PRODUCTION MATERIAL: **ABS & PLASTIC**  
ΥΛΙΚΟ ΚΑΤΑΣΚΕΥΗΣ: **ABS & ΠΛΑΣΤΙΚΟ**



PRO

2 YEARS WARRANTY

White Box with Sticker PACKING

| IP65          | A ENERGY CLASS | VOLT 220-240V 50-60Hz | LUMENS 85/W | SMD 2835 | CLASS II     | 25°C - +45°C OPERATING TEMP. | 0,380Kg                 |           |
|---------------|----------------|-----------------------|-------------|----------|--------------|------------------------------|-------------------------|-----------|
| 110°          | Ticker free    | PF >0.8               | Ra >80      | IK 06    | 30000 ON-OFF | 25000h LIFE TIME             | START TIME min: 0.5 sec |           |
| BARCODE       | CODE           | WATT                  | AMPERAGE    | KELVIN   | DIMENSIONS   | COLOR                        | PACKING                 | PRICE (€) |
| 5207227015625 | 145-52040      | 12W                   | 100mA       | 3000K    | 265x99x96mm  | BLACK                        | 1/10                    | 55.60     |
| 5207227015656 | 145-52042      | 12W                   | 100mA       | 3000K    | 265x99x96mm  | GREY                         | 1/10                    | 55.60     |

PRODUCTION MATERIAL: **ABS & PLASTIC**  
ΥΛΙΚΟ ΚΑΤΑΣΚΕΥΗΣ: **ABS & ΠΛΑΣΤΙΚΟ**



PRO

2 YEARS WARRANTY

White Box with Sticker PACKING

| IP65          | A ENERGY CLASS | VOLT 220-240V 50-60Hz | LUMENS 85/W | SMD 2835 | CLASS II      | 25°C - +45°C OPERATING TEMP. | 0,717Kg                 |           |
|---------------|----------------|-----------------------|-------------|----------|---------------|------------------------------|-------------------------|-----------|
| 120°          | Ticker free    | PF >0.8               | Ra >80      | IK 06    | 30000 ON-OFF  | 25000h LIFE TIME             | START TIME min: 0.5 sec |           |
| BARCODE       | CODE           | WATT                  | AMPERAGE    | KELVIN   | DIMENSIONS    | COLOR                        | PACKING                 | PRICE (€) |
| 5207227015564 | 145-52034      | 12W                   | 120mA       | 3000K    | 320x130x129mm | WHITE                        | 1/12                    | 62.45     |
| 5207227015595 | 145-52036      | 12W                   | 120mA       | 3000K    | 320x130x129mm | GREY                         | 1/12                    | 62.45     |

PRODUCTION MATERIAL: **ALUMINIUM & PLASTIC**  
ΥΛΙΚΟ ΚΑΤΑΣΚΕΥΗΣ: **ΑΛΟΥΜΙΝΙΟ & ΠΛΑΣΤΙΚΟ**

WITH COVER ΜΕ ΚΑΛΥΠΤΡΑ

**NEW!**



PRO

2 YEARS WARRANTY

Color Box PACKING

| IP65          | A ENERGY CLASS | VOLT 220-240V 50-60Hz | LUMENS 75/W | SMD 2835 | CLASS II      | 25°C - +45°C OPERATING TEMP. | 0,600Kg 0,710Kg*        |           |
|---------------|----------------|-----------------------|-------------|----------|---------------|------------------------------|-------------------------|-----------|
| 128°          | Ticker free    | PF >0.5               | Ra >80      | IK 06    | 25000 ON-OFF  | 20000h LIFE TIME             | START TIME min: 0.5 sec |           |
| BARCODE       | CODE           | WATT                  | AMPERAGE    | KELVIN   | DIMENSIONS    | COLOR                        | PACKING                 | PRICE (€) |
| 5207227062506 | 145-20200      | 12W                   | 100mA       | 3000K    | ø169x100mm    | BLACK                        | 1/20                    | 44.85     |
| 5207227062520 | 145-20201*     | 12W                   | 100mA       | 3000K    | 160x160x100mm | BLACK                        | 1/20                    | 47.90     |

WALL MOUNTED LED FIXTURES • ΑΠΛΙΚΕΣ ΤΟΙΧΟΥ LED

WALL MOUNTED LED FIXTURES • ΑΠΛΙΚΕΣ ΤΟΙΧΟΥ LED

PRODUCTION MATERIAL: ALUMINIUM & PLASTIC  
ΥΛΙΚΟ ΚΑΤΑΣΚΕΥΗΣ: ΑΛΟΥΜΙΝΙΟ & ΠΛΑΣΤΙΚΟ

WITH COVER  
ΜΕ ΚΑΛΥΠΤΡΑ

**NEW!**

IP65 ENERGY CLASS A VOLT 220-240V 50-60Hz LUMENS 80/W SMD 2835 CLASS II 25°C ~ +45°C OPERATING TEMP. 0,530Kg 0,600Kg\*

BEAM ANGLE 158° Flicker free PF >0.5 Ra >80 IK 06 25000 ON-OFF 20000h LIFE TIME START TIME min: 0.5 sec

| BARCODE       | CODE       | WATT | AMPERAGE | KELVIN | DIMENSIONS    | COLOR | PACKING | PRICE (€) |
|---------------|------------|------|----------|--------|---------------|-------|---------|-----------|
| 5207227062544 | 145-20202  | 12W  | 100mA    | 3000K  | ∅169x100mm    | BLACK | 1/20    | 43.25     |
| 5207227062568 | 145-20203* | 12W  | 100mA    | 3000K  | 160x160x100mm | BLACK | 1/20    | 44.85     |

PRODUCTION MATERIAL: ALUMINIUM & PLASTIC  
ΥΛΙΚΟ ΚΑΤΑΣΚΕΥΗΣ: ΑΛΟΥΜΙΝΙΟ & ΠΛΑΣΤΙΚΟ

WITH ROTATING BASE  
ΜΕ ΠΕΡΙΣΤΡΕΦΟΜΕΝΗ ΒΑΣΗ

**NEW!**

IP54 ENERGY CLASS A VOLT 220-240V 50-60Hz LUMENS 85/W SMD 2835 CLASS I 25°C ~ +45°C OPERATING TEMP. GROUNDING 0,450Kg

BEAM ANGLE 163° Flicker free PF >0.5 Ra >80 IK 08 25000 ON-OFF 30000h LIFE TIME START TIME min: 0.5 sec

| BARCODE       | CODE      | WATT | AMPERAGE | KELVIN | DIMENSIONS   | COLOR     | PACKING | PRICE (€) |
|---------------|-----------|------|----------|--------|--------------|-----------|---------|-----------|
| 5207227062742 | 145-20207 | 8W   | 120mA    | 3000K  | 114x90x105mm | DARK GREY | 1/8     | 63.50     |

PRODUCTION MATERIAL: ALUMINIUM & PLASTIC  
ΥΛΙΚΟ ΚΑΤΑΣΚΕΥΗΣ: ΑΛΟΥΜΙΝΙΟ & ΠΛΑΣΤΙΚΟ

**NEW!**

IP54 ENERGY CLASS A VOLT 220-240V 50-60Hz LUMENS 85/W SMD 2835 CLASS I 25°C ~ +45°C OPERATING TEMP. GROUNDING 1,250Kg 0,625Kg\*

BEAM ANGLE 120° Flicker free PF >0.5 Ra >80 IK 06 25000 ON-OFF 30000h LIFE TIME START TIME min: 0.5 sec

| BARCODE       | CODE       | WATT | AMPERAGE | KELVIN | DIMENSIONS  | COLOR | PACKING | PRICE (€) |
|---------------|------------|------|----------|--------|-------------|-------|---------|-----------|
| 5207227062902 | 145-20204  | 16W  | 140mA    | 3000K  | ∅250x50mm   | BLACK | 1/10    | 85.60     |
| 5207227062919 | 145-20205* | 7W   | 70mA     | 3000K  | 233x77x90mm | BLACK | 1/20    | 58.60     |

PRODUCTION MATERIAL: ALUMINIUM & PLASTIC  
ΥΛΙΚΟ ΚΑΤΑΣΚΕΥΗΣ: ΑΛΟΥΜΙΝΙΟ & ΠΛΑΣΤΙΚΟ

**NEW!**

IP54 ENERGY CLASS A VOLT 220-240V 50-60Hz LUMENS 85/W SMD 2835 CLASS I 25°C ~ +45°C OPERATING TEMP. GROUNDING 0,650Kg

BEAM ANGLE 350° Flicker free PF >0.5 Ra >80 IK 08 25000 ON-OFF 30000h LIFE TIME START TIME min: 0.5 sec

| BARCODE       | CODE      | WATT | AMPERAGE | KELVIN | DIMENSIONS   | COLOR     | PACKING | PRICE (€) |
|---------------|-----------|------|----------|--------|--------------|-----------|---------|-----------|
| 5207227062766 | 145-20208 | 12W  | 180mA    | 3000K  | 220x170x55mm | DARK GREY | 1/8     | 86.75     |

PRODUCTION MATERIAL: ALUMINIUM & PLASTIC  
ΥΛΙΚΟ ΚΑΤΑΣΚΕΥΗΣ: ΑΛΟΥΜΙΝΙΟ & ΠΛΑΣΤΙΚΟ

**NEW!**

IP65 ENERGY CLASS A VOLT 220-240V 50-60Hz LUMENS 85/W SMD 3030 CLASS I 25°C ~ +45°C OPERATING TEMP. GROUNDING 0,650Kg

BEAM ANGLE 102° Flicker free PF >0.5 Ra >80 IK 08 25000 ON-OFF 30000h LIFE TIME START TIME min: 0.5 sec

| BARCODE       | CODE      | WATT | AMPERAGE | KELVIN | DIMENSIONS   | COLOR     | PACKING | PRICE (€) |
|---------------|-----------|------|----------|--------|--------------|-----------|---------|-----------|
| 5207227062728 | 145-20206 | 13W  | 300mA    | 3000K  | 240x55x105mm | DARK GREY | 1/12    | 77.65     |

PRODUCTION MATERIAL: ALUMINIUM & PLASTIC  
ΥΛΙΚΟ ΚΑΤΑΣΚΕΥΗΣ: ΑΛΟΥΜΙΝΙΟ & ΠΛΑΣΤΙΚΟ

**NEW!**

IP54 ENERGY CLASS A VOLT 220-240V 50-60Hz LUMENS 85/W SMD 2835 CLASS I 25°C ~ +45°C OPERATING TEMP. GROUNDING 0,660Kg

BEAM ANGLE 350° Flicker free PF >0.5 Ra >80 IK 08 25000 ON-OFF 30000h LIFE TIME START TIME min: 0.5 sec

| BARCODE       | CODE      | WATT | AMPERAGE | KELVIN | DIMENSIONS   | COLOR     | PACKING | PRICE (€) |
|---------------|-----------|------|----------|--------|--------------|-----------|---------|-----------|
| 5207227062780 | 145-20209 | 12W  | 180mA    | 3000K  | 240x120x45mm | DARK GREY | 1/12    | 85.45     |

WALL MOUNTED LED FIXTURES • ΑΠΛΙΚΕΣ ΤΟΙΧΟΥ LED

PRODUCTION MATERIAL: ALUMINIUM & PLASTIC  
ΥΛΙΚΟ ΚΑΤΑΣΚΕΥΗΣ: ΑΛΟΥΜΙΝΙΟ & ΠΛΑΣΤΙΚΟ

**NEW!**

PRO  
5 YEARS GUARANTEE  
Color Box PACKING

IP54 BASE E27 -25°C ~ +45°C OPERATING TEMP. GROUNDING 0,550Kg

| BARCODE       | CODE      | WATT                      | DIMENSIONS    | COLOR | PACKING | PRICE (€) |
|---------------|-----------|---------------------------|---------------|-------|---------|-----------|
| 5207227062650 | 145-20210 | max 10W LED / 42W Halogen | 220x108x121mm | WHITE | 1/10    | 32.65     |
| 5207227062667 | 145-20211 | max 10W LED / 42W Halogen | 220x108x121mm | BLACK | 1/10    | 32.65     |
| 5207227062674 | 145-20212 | max 10W LED / 42W Halogen | 220x108x121mm | GREY  | 1/10    | 32.65     |

**NEW!**

PRO  
5 YEARS GUARANTEE  
Color Box PACKING

IP54 BASE E27 -25°C ~ +45°C OPERATING TEMP. GROUNDING 0,470Kg

| BARCODE       | CODE      | WATT                      | DIMENSIONS   | COLOR | PACKING | PRICE (€) |
|---------------|-----------|---------------------------|--------------|-------|---------|-----------|
| 5207227062681 | 145-20213 | max 10W LED / 42W Halogen | 220x100x99mm | WHITE | 1/10    | 31.35     |
| 5207227062698 | 145-20214 | max 10W LED / 42W Halogen | 220x100x99mm | BLACK | 1/10    | 31.35     |
| 5207227062704 | 145-20215 | max 10W LED / 42W Halogen | 220x100x99mm | GREY  | 1/10    | 31.35     |

WALL MOUNTED LED FIXTURES • ΑΠΛΙΚΕΣ ΤΟΙΧΟΥ LED

PRODUCTION MATERIAL: ALUMINIUM & PLASTIC  
ΥΛΙΚΟ ΚΑΤΑΣΚΕΥΗΣ: ΑΛΟΥΜΙΝΙΟ & ΠΛΑΣΤΙΚΟ

**NEW!**

PRO  
2 YEARS GUARANTEE  
Color Box PACKING

IP54 ENERGY CLASS A+ VOLT 220-240V 50-60Hz LUMENS 65/W SMD 2835 CLASS I 25°C ~ +45°C OPERATING TEMP. GROUNDING 1,050Kg

BEAM ANGLE 120° Flicker free PF >0.5 Ra >80 IK 06 25000 ON-OFF 35000h LIFE TIME START TIME min: 0.5 sec

| BARCODE       | CODE      | WATT | AMPERAGE | KELVIN | DIMENSIONS   | COLOR | PACKING | PRICE (€) |
|---------------|-----------|------|----------|--------|--------------|-------|---------|-----------|
| 5207227063312 | 145-20216 | 9W   | 70mA     | 3000K  | 240x158x70mm | BLACK | 1/12    | 78.80     |

**NEW!**

PRO  
2 YEARS GUARANTEE  
Color Box PACKING

IP54 ENERGY CLASS A+ VOLT 220-240V 50-60Hz LUMENS 70/W SMD 2835 CLASS I 20°C ~ +45°C OPERATING TEMP. GROUNDING 1,020Kg

BEAM ANGLE 120° Flicker free PF >0.5 Ra >80 IK 07 25000 ON-OFF 35000h LIFE TIME START TIME min: 0.5 sec

| BARCODE       | CODE      | WATT | AMPERAGE | KELVIN | DIMENSIONS   | COLOR | PACKING | PRICE (€) |
|---------------|-----------|------|----------|--------|--------------|-------|---------|-----------|
| 5207227063398 | 145-20220 | 13W  | 113mA    | 3000K  | 240x120x40mm | BLACK | 1/18    | 78.65     |



GUTTER LIGHTS • ΚΑΡΑΒΟΧΕΛΩΝΕΣ



PRODUCTION MATERIAL: **PLASTIC**  
ΥΛΙΚΟ ΚΑΤΑΣΚΕΥΗΣ: **ΠΛΑΣΤΙΚΟ**



| BARCODE       | CODE      | WATT                      | DIMENSIONS   | COLOR | PACKING | PRICE (€) |
|---------------|-----------|---------------------------|--------------|-------|---------|-----------|
| 5206139306005 | 147-55200 | max 10W LED / 28W Halogen | 175x95x120mm | WHITE | 1/30    | 7.25      |

PRODUCTION MATERIAL: **PLASTIC & GLASS**  
ΥΛΙΚΟ ΚΑΤΑΣΚΕΥΗΣ: **ΠΛΑΣΤΙΚΟ & ΓΥΑΛΙ**

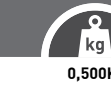
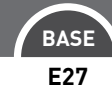

| BARCODE       | CODE      | WATT                      | DIMENSIONS    | COLOR | PACKING | PRICE (€) |
|---------------|-----------|---------------------------|---------------|-------|---------|-----------|
| 5206139306012 | 147-55201 | max 10W LED / 42W Halogen | 205x100x118mm | WHITE | 1/20    | 6.85      |
| 5206139306029 | 147-55202 | max 10W LED / 42W Halogen | 205x100x118mm | BLACK | 1/20    | 6.85      |

PRODUCTION MATERIAL: **ALUMINIUM & GLASS**  
ΥΛΙΚΟ ΚΑΤΑΣΚΕΥΗΣ: **ΑΛΟΥΜΙΝΙΟ & ΓΥΑΛΙ**

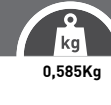

| BARCODE       | CODE      | WATT                      | DIMENSIONS   | COLOR | PACKING | PRICE (€) |
|---------------|-----------|---------------------------|--------------|-------|---------|-----------|
| 5206139304070 | 147-55007 | max 10W LED / 42W Halogen | 210x105x85mm | WHITE | 1/20    | 7.95      |
| 5206139304087 | 147-55008 | max 10W LED / 42W Halogen | 210x105x85mm | BLACK | 1/20    | 7.95      |
| 5206139304797 | 147-55079 | max 10W LED / 42W Halogen | 210x105x85mm | GREY  | 1/20    | 7.95      |

CEILING LIGHTS • ΠΛΑΦΟΝΙΕΡΕΣ ΟΡΟΦΗΣ



PRODUCTION MATERIAL: **ALUMINIUM & GLASS**  
ΥΛΙΚΟ ΚΑΤΑΣΚΕΥΗΣ: **ΑΛΟΥΜΙΝΙΟ & ΓΥΑΛΙ**



| BARCODE       | CODE      | WATT                      | DIMENSIONS | COLOR | PACKING | PRICE (€) |
|---------------|-----------|---------------------------|------------|-------|---------|-----------|
| 5206139304056 | 147-55005 | max 10W LED / 42W Halogen | ∅180x90mm  | WHITE | 1/20    | 7.95      |
| 5206139304063 | 147-55006 | max 10W LED / 42W Halogen | ∅180x90mm  | BLACK | 1/20    | 7.95      |

PRODUCTION MATERIAL: **ALUMINIUM**  
ΥΛΙΚΟ ΚΑΤΑΣΚΕΥΗΣ: **ΑΛΟΥΜΙΝΙΟ**

WITH COVER  
ΜΕ ΚΑΛΥΠΤΡΑ



| BARCODE       | CODE      | WATT                      | DIMENSIONS    | COLOR | PACKING | PRICE (€) |
|---------------|-----------|---------------------------|---------------|-------|---------|-----------|
| 5206139304698 | 147-55069 | max 10W LED / 42W Halogen | 270x130x110mm | GREY  | 1/10    | 19.90     |

PRODUCTION MATERIAL: **ALUMINIUM**  
ΥΛΙΚΟ ΚΑΤΑΣΚΕΥΗΣ: **ΑΛΟΥΜΙΝΙΟ**



| BARCODE       | CODE      | WATT                      | DIMENSIONS    | COLOR | PACKING | PRICE (€) |
|---------------|-----------|---------------------------|---------------|-------|---------|-----------|
| 5206139304704 | 147-55070 | max 10W LED / 42W Halogen | 270x130x100mm | BLACK | 1/10    | 18.80     |
| 5206139304711 | 147-55071 | max 10W LED / 42W Halogen | 270x130x100mm | WHITE | 1/10    | 18.80     |
| 5206139304728 | 147-55072 | max 10W LED / 42W Halogen | 270x130x100mm | GREY  | 1/10    | 18.80     |

WALL LIGHTS • ΑΠΛΙΚΕΣ ΤΟΙΧΟΥ  
 PRODUCTION MATERIAL: **ALUMINIUM & GLASS**  
 ΥΛΙΚΟ ΚΑΤΑΣΚΕΥΗΣ: **ΑΛΟΥΜΙΝΙΟ & ΓΥΑΛΙ**



IP44 BASE E27 -20°C ~ +45°C OPERATING TEMP. GROUNDING 0,610Kg

Color Box PACKING

| BARCODE       | CODE      | WATT                      | DIMENSIONS    | COLOR | PACKING | PRICE (€) |
|---------------|-----------|---------------------------|---------------|-------|---------|-----------|
| 5206139304605 | 147-55060 | max 10W LED / 42W Halogen | 215x150x100mm | WHITE | 1/20    | 12.65     |
| 5206139304612 | 147-55061 | max 10W LED / 42W Halogen | 215x150x100mm | BLACK | 1/20    | 12.65     |
| 5206139304629 | 147-55062 | max 10W LED / 42W Halogen | 215x150x100mm | GREY  | 1/20    | 12.65     |



IP44 BASE E27 -20°C ~ +45°C OPERATING TEMP. GROUNDING 0,690Kg

Color Box PACKING

| BARCODE       | CODE      | WATT                      | DIMENSIONS    | COLOR | PACKING | PRICE (€) |
|---------------|-----------|---------------------------|---------------|-------|---------|-----------|
| 5206139304636 | 147-55063 | max 10W LED / 42W Halogen | 215x150x100mm | WHITE | 1/20    | 12.65     |
| 5206139304643 | 147-55064 | max 10W LED / 42W Halogen | 215x150x100mm | BLACK | 1/20    | 12.65     |
| 5206139304650 | 147-55065 | max 10W LED / 42W Halogen | 215x150x100mm | GREY  | 1/20    | 12.65     |



IP44 BASE E27 -20°C ~ +45°C OPERATING TEMP. GROUNDING 0,710Kg

Color Box PACKING

| BARCODE       | CODE      | WATT                      | DIMENSIONS    | COLOR | PACKING | PRICE (€) |
|---------------|-----------|---------------------------|---------------|-------|---------|-----------|
| 5206139304667 | 147-55066 | max 10W LED / 42W Halogen | 215x150x100mm | WHITE | 1/20    | 12.65     |
| 5206139304674 | 147-55067 | max 10W LED / 42W Halogen | 215x150x100mm | BLACK | 1/20    | 12.65     |
| 5206139304681 | 147-55068 | max 10W LED / 42W Halogen | 215x150x100mm | GREY  | 1/20    | 12.65     |

WALL LIGHTS • ΑΠΛΙΚΕΣ ΤΟΙΧΟΥ

PRODUCTION MATERIAL: **STAINLESS STEEL**  
 ΥΛΙΚΟ ΚΑΤΑΣΚΕΥΗΣ: **ΑΝΟΞΕΙΩΤΟ ΑΤΣΑΛΙ**



IP44 BASE GU10 -20°C ~ +45°C OPERATING TEMP. GROUNDING 0,380Kg 0,580Kg\*

Color Box PACKING

| BARCODE       | CODE       | WATT                     | DIMENSIONS   | COLOR  | PACKING | PRICE (€) |
|---------------|------------|--------------------------|--------------|--------|---------|-----------|
| 5206139044709 | 147-82020  | max 6W LED / 33W Halogen | 92x110x140mm | NICKEL | 1/20    | 27.90     |
| 5206139044723 | 147-82021* | max 6W LED / 33W Halogen | 92x160x160mm | NICKEL | 1/20    | 32.80     |



PRODUCTION MATERIAL: **ALUMINIUM**  
 ΥΛΙΚΟ ΚΑΤΑΣΚΕΥΗΣ: **ΑΛΟΥΜΙΝΙΟ**

IP44 BASE GU10 IK 08 -20°C ~ +50°C OPERATING TEMP. GROUNDING 0,350Kg 0,540Kg\*

Color Box PACKING

| BARCODE       | CODE       | WATT                     | DIMENSIONS  | COLOR | PACKING | PRICE (€) |
|---------------|------------|--------------------------|-------------|-------|---------|-----------|
| 5206139044747 | 147-82022  | max 7W LED / 42W Halogen | 65x95x80mm  | SATIN | 1/20    | 23.85     |
| 5206139044778 | 147-82023* | max 7W LED / 42W Halogen | 65x95x150mm | SATIN | 1/20    | 28.30     |



PRODUCTION MATERIAL: **ALUMINIUM**  
 ΥΛΙΚΟ ΚΑΤΑΣΚΕΥΗΣ: **ΑΛΟΥΜΙΝΙΟ**

IP44 BASE GU10 IK 08 -20°C ~ +50°C OPERATING TEMP. GROUNDING 0,375Kg 0,580Kg\*

Color Box PACKING

| BARCODE       | CODE       | WATT                     | DIMENSIONS  | COLOR | PACKING | PRICE (€) |
|---------------|------------|--------------------------|-------------|-------|---------|-----------|
| 5206139044792 | 147-82024  | max 7W LED / 42W Halogen | 65x92x68mm  | SATIN | 1/20    | 23.85     |
| 5206139044822 | 147-82025* | max 7W LED / 42W Halogen | 65x92x150mm | SATIN | 1/20    | 28.30     |

WALL LIGHTS • ΑΠΛΙΚΕΣ ΤΟΙΧΟΥ

Down

PRODUCTION MATERIAL: **ABS & PLASTIC**  
ΥΛΙΚΟ ΚΑΤΑΣΚΕΥΗΣ: **ABS & ΠΛΑΣΤΙΚΟ**



| BARCODE       | CODE      | WATT                     | DIMENSIONS   | COLOR          | PACKING | PRICE (€) |
|---------------|-----------|--------------------------|--------------|----------------|---------|-----------|
| 5207227015687 | 145-82010 | max 6W LED / 28W Halogen | φ76x99x148mm | WHITE          | 1/20    | 23.20     |
| 5207227015717 | 145-82011 | max 6W LED / 28W Halogen | φ76x99x148mm | BLACK          | 1/20    | 23.20     |
| 5207227015748 | 145-82012 | max 6W LED / 28W Halogen | φ76x99x148mm | GREY           | 1/20    | 23.20     |
| 5207227015779 | 145-82013 | max 6W LED / 28W Halogen | φ76x99x148mm | ANTIQUE BRONZE | 1/20    | 23.20     |

WALL LIGHTS • ΑΠΛΙΚΕΣ ΤΟΙΧΟΥ

Down

PRODUCTION MATERIAL: **ABS & PLASTIC**  
ΥΛΙΚΟ ΚΑΤΑΣΚΕΥΗΣ: **ABS & ΠΛΑΣΤΙΚΟ**



| BARCODE       | CODE      | WATT                     | DIMENSIONS  | COLOR          | PACKING | PRICE (€) |
|---------------|-----------|--------------------------|-------------|----------------|---------|-----------|
| 5207227015144 | 145-82000 | max 6W LED / 28W Halogen | 99x76x148mm | WHITE          | 1/20    | 23.20     |
| 5207227015175 | 145-82001 | max 6W LED / 28W Halogen | 99x76x148mm | BLACK          | 1/20    | 23.20     |
| 5207227015205 | 145-82002 | max 6W LED / 28W Halogen | 99x76x148mm | GREY           | 1/20    | 23.20     |
| 5207227015236 | 145-82003 | max 6W LED / 28W Halogen | 99x76x148mm | DARK GREY      | 1/20    | 23.20     |
| 5207227015267 | 145-82004 | max 6W LED / 28W Halogen | 99x76x148mm | ANTIQUE BRONZE | 1/20    | 23.20     |

Up-Down

PRODUCTION MATERIAL: **ABS & PLASTIC**  
ΥΛΙΚΟ ΚΑΤΑΣΚΕΥΗΣ: **ABS & ΠΛΑΣΤΙΚΟ**



| BARCODE       | CODE      | WATT                     | DIMENSIONS   | COLOR          | PACKING | PRICE (€) |
|---------------|-----------|--------------------------|--------------|----------------|---------|-----------|
| 5207227015809 | 145-82014 | max 6W LED / 28W Halogen | φ76x99x186mm | WHITE          | 1/20    | 30.65     |
| 5207227015830 | 145-82015 | max 6W LED / 28W Halogen | φ76x99x186mm | BLACK          | 1/20    | 30.65     |
| 5207227015861 | 145-82016 | max 6W LED / 28W Halogen | φ76x99x186mm | GREY           | 1/20    | 30.65     |
| 5207227015892 | 145-82017 | max 6W LED / 28W Halogen | φ76x99x186mm | ANTIQUE BRONZE | 1/20    | 30.65     |

Up-Down

PRODUCTION MATERIAL: **ABS & PLASTIC**  
ΥΛΙΚΟ ΚΑΤΑΣΚΕΥΗΣ: **ABS & ΠΛΑΣΤΙΚΟ**



| BARCODE       | CODE      | WATT                     | DIMENSIONS  | COLOR          | PACKING | PRICE (€) |
|---------------|-----------|--------------------------|-------------|----------------|---------|-----------|
| 5207227015298 | 145-82005 | max 6W LED / 28W Halogen | 99x76x186mm | WHITE          | 1/20    | 30.65     |
| 5207227015328 | 145-82006 | max 6W LED / 28W Halogen | 99x76x186mm | BLACK          | 1/20    | 30.65     |
| 5207227015359 | 145-82007 | max 6W LED / 28W Halogen | 99x76x186mm | GREY           | 1/20    | 30.65     |
| 5207227015380 | 145-82008 | max 6W LED / 28W Halogen | 99x76x186mm | DARK GREY      | 1/20    | 30.65     |
| 5207227015410 | 145-82009 | max 6W LED / 28W Halogen | 99x76x186mm | ANTIQUE BRONZE | 1/20    | 30.65     |

WALL LIGHTS • ΑΠΛΙΚΕΣ ΤΟΙΧΟΥ



Down



PRODUCTION MATERIAL: **ALUMINIUM**  
ΥΛΙΚΟ ΚΑΤΑΣΚΕΥΗΣ: **ΑΛΟΥΜΙΝΙΟ**



BASE  
GU10

IK  
06

-20 °C ~ +60 °C  
OPERATING TEMP.

GROUNDING

kg  
0,330Kg

Color Box  
PACKING

| BARCODE       | CODE      | WATT                     | DIMENSIONS | COLOR | PACKING | PRICE (€) |
|---------------|-----------|--------------------------|------------|-------|---------|-----------|
| 5207227072970 | 145-20500 | max 7W LED / 28W Halogen | 68x80x92mm | WHITE | 1/50    | 18.35     |
| 5207227076503 | 145-20501 | max 7W LED / 28W Halogen | 68x80x92mm | BLACK | 1/50    | 18.35     |
| 5207227076510 | 145-20502 | max 7W LED / 28W Halogen | 68x80x92mm | GREY  | 1/50    | 18.35     |



Up-Down



PRODUCTION MATERIAL: **ALUMINIUM**  
ΥΛΙΚΟ ΚΑΤΑΣΚΕΥΗΣ: **ΑΛΟΥΜΙΝΙΟ**



BASE  
GU10

IK  
06

-20 °C ~ +60 °C  
OPERATING TEMP.

GROUNDING

kg  
0,575Kg

Color Box  
PACKING

| BARCODE       | CODE      | WATT                     | DIMENSIONS  | COLOR | PACKING | PRICE (€) |
|---------------|-----------|--------------------------|-------------|-------|---------|-----------|
| 5207227076527 | 145-20503 | max 7W LED / 28W Halogen | 68x150x92mm | WHITE | 1/20    | 25.80     |
| 5207227076534 | 145-20504 | max 7W LED / 28W Halogen | 68x150x92mm | BLACK | 1/20    | 25.80     |
| 5207227076541 | 145-20505 | max 7W LED / 28W Halogen | 68x150x92mm | GREY  | 1/20    | 25.80     |



Down



PRODUCTION MATERIAL: **ALUMINIUM**  
ΥΛΙΚΟ ΚΑΤΑΣΚΕΥΗΣ: **ΑΛΟΥΜΙΝΙΟ**



BASE  
GU10

IK  
06

-20 °C ~ +60 °C  
OPERATING TEMP.

GROUNDING

kg  
0,330Kg

Color Box  
PACKING

| BARCODE       | CODE      | WATT                     | DIMENSIONS | COLOR | PACKING | PRICE (€) |
|---------------|-----------|--------------------------|------------|-------|---------|-----------|
| 5207227076558 | 145-20506 | max 7W LED / 28W Halogen | 67x80x92mm | WHITE | 1/50    | 21.60     |
| 5207227076565 | 145-20507 | max 7W LED / 28W Halogen | 67x80x92mm | BLACK | 1/50    | 21.60     |
| 5207227076572 | 145-20508 | max 7W LED / 28W Halogen | 67x80x92mm | GREY  | 1/50    | 21.60     |

WALL LIGHTS • ΑΠΛΙΚΕΣ ΤΟΙΧΟΥ



Up-Down



PRODUCTION MATERIAL: **ALUMINIUM**  
ΥΛΙΚΟ ΚΑΤΑΣΚΕΥΗΣ: **ΑΛΟΥΜΙΝΙΟ**



BASE  
GU10

IK  
06

-20 °C ~ +60 °C  
OPERATING TEMP.

GROUNDING

kg  
0,575Kg

Color Box  
PACKING

| BARCODE       | CODE      | WATT                     | DIMENSIONS  | COLOR | PACKING | PRICE (€) |
|---------------|-----------|--------------------------|-------------|-------|---------|-----------|
| 5207227076589 | 145-20509 | max 7W LED / 28W Halogen | 68x150x92mm | WHITE | 1/20    | 27.20     |
| 5207227076596 | 145-20510 | max 7W LED / 28W Halogen | 68x150x92mm | BLACK | 1/20    | 27.20     |
| 5207227076602 | 145-20511 | max 7W LED / 28W Halogen | 68x150x92mm | GREY  | 1/20    | 27.20     |



Down



PRODUCTION MATERIAL: **ALUMINIUM**  
ΥΛΙΚΟ ΚΑΤΑΣΚΕΥΗΣ: **ΑΛΟΥΜΙΝΙΟ**



BASE  
GU10

IK  
06

-20 °C ~ +60 °C  
OPERATING TEMP.

GROUNDING

kg  
0,600Kg

Color Box  
PACKING

| BARCODE       | CODE      | WATT                     | DIMENSIONS   | COLOR | PACKING | PRICE (€) |
|---------------|-----------|--------------------------|--------------|-------|---------|-----------|
| 5207227076619 | 145-20512 | max 7W LED / 28W Halogen | 125x156x88mm | WHITE | 1/20    | 30.55     |
| 5207227076626 | 145-20513 | max 7W LED / 28W Halogen | 125x156x88mm | BLACK | 1/20    | 30.55     |
| 5207227062926 | 145-20514 | max 7W LED / 28W Halogen | 125x156x88mm | GREY  | 1/20    | 30.55     |



GARDEN SPOT LIGHTS • ΣΠΟΤ ΚΗΠΟΥ



PRODUCTION MATERIAL: **ABS & PLASTIC**  
ΥΛΙΚΟ ΚΑΤΑΣΚΕΥΗΣ: **ABS & ΠΛΑΣΤΙΚΟ**

NAILED  
ΚΑΡΦΟΤΟ



| BARCODE       | CODE      | WATT       | DIMENSIONS   | COLOR | PACKING | PRICE (€) |
|---------------|-----------|------------|--------------|-------|---------|-----------|
| 5207227015922 | 145-82020 | max 5W LED | ø60x60x322mm | WHITE | 1/20    | 16.25     |
| 5207227015953 | 145-82021 | max 5W LED | ø60x60x322mm | BLACK | 1/20    | 16.25     |
| 5207227015984 | 145-82022 | max 5W LED | ø60x60x322mm | GREY  | 1/20    | 16.25     |



PRODUCTION MATERIAL: **ALUMINIUM & GLASS**  
ΥΛΙΚΟ ΚΑΤΑΣΚΕΥΗΣ: **ΑΛΟΥΜΙΝΙΟ & ΓΥΑΛΙ**



| BARCODE       | CODE      | WATT                     | DIMENSIONS | COLOR | PACKING | PRICE (€) |
|---------------|-----------|--------------------------|------------|-------|---------|-----------|
| 5206139324108 | 147-68410 | max 6W LED / 33W Halogen | ø100x155mm | WHITE | 1/30    | 11.95     |
| 5206139324115 | 147-68411 | max 6W LED / 33W Halogen | ø100x155mm | BLACK | 1/30    | 11.95     |
| 5206139324122 | 147-68412 | max 6W LED / 33W Halogen | ø100x155mm | GREY  | 1/30    | 11.95     |



PRODUCTION MATERIAL: **ALUMINIUM & GLASS**  
ΥΛΙΚΟ ΚΑΤΑΣΚΕΥΗΣ: **ΑΛΟΥΜΙΝΙΟ & ΓΥΑΛΙ**

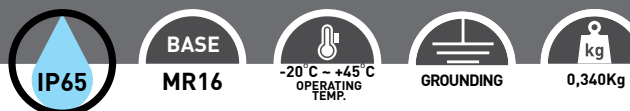

| BARCODE       | CODE      | WATT                     | DIMENSIONS | COLOR | PACKING | PRICE (€) |
|---------------|-----------|--------------------------|------------|-------|---------|-----------|
| 5206139324009 | 147-68400 | max 6W LED / 33W Halogen | ø100x155mm | WHITE | 1/30    | 11.75     |
| 5206139324016 | 147-68401 | max 6W LED / 33W Halogen | ø100x155mm | BLACK | 1/30    | 11.75     |
| 5206139324023 | 147-68402 | max 6W LED / 33W Halogen | ø100x155mm | GREY  | 1/30    | 11.75     |

SPOT LIGHTS • ΣΠΟΤ



PRODUCTION MATERIAL: **ALUMINIUM**  
ΥΛΙΚΟ ΚΑΤΑΣΚΕΥΗΣ: **ΑΛΟΥΜΙΝΙΟ**

147-68704

147-68705

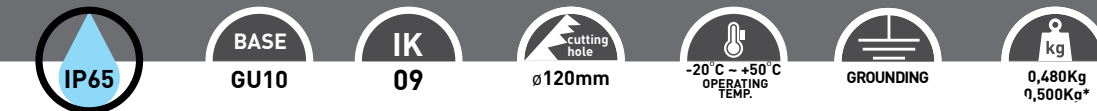

| BARCODE       | CODE       | WATT                     | DIMENSIONS    | COLOR | PACKING | PRICE (€) |
|---------------|------------|--------------------------|---------------|-------|---------|-----------|
| 5206139327048 | 147-68704  | max 6W LED / 33W Halogen | ø110x125mm    | SATIN | 1/12    | 29.60     |
| 5206139327062 | 147-68706* | max 6W LED / 33W Halogen | 110x110x125mm | SATIN | 1/12    | 29.60     |



PRODUCTION MATERIAL: **PP**  
ΥΛΙΚΟ ΚΑΤΑΣΚΕΥΗΣ: **PP**

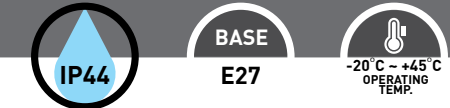

| BARCODE       | CODE      | WATT                      | DIMENSIONS   | WEIGHT   | COLOR | PACKING | PRICE (€) |
|---------------|-----------|---------------------------|--------------|----------|-------|---------|-----------|
| 5206139329028 | 147-68902 | max 15W LED / 80W Halogen | ø70x75x220mm | 0,350 kg | BLACK | 1/20    | 6.55      |
| 5206139329004 | 147-68900 | max 15W LED / 80W Halogen | ø70x420mm    | 0,600 kg | BLACK | 1/30    | 6.85      |
| 5206139329011 | 147-68901 | max 15W LED / 80W Halogen | ø75x420mm    | 0,766 kg | BLACK | 1/20    | 11.15     |

ACCESSORIES FOR SPOT LIGHTS • ΑΞΕΣΟΥΑΡ ΓΙΑ ΣΠΟΤ



PRODUCTION MATERIAL: **ALUMINIUM**  
ΥΛΙΚΟ ΚΑΤΑΣΚΕΥΗΣ: **ΑΛΟΥΜΙΝΙΟ**



| BARCODE       | CODE      | DIMENSIONS  | COLOR | PACKING | PRICE (€) |
|---------------|-----------|-------------|-------|---------|-----------|
| 5206139394002 | 147-22400 | 30x30x170mm | WHITE | 1/100   | 2.35      |
| 5206139394040 | 147-22404 | 30x30x170mm | BLACK | 1/100   | 2.35      |
| 5206139394057 | 147-22405 | 30x30x170mm | GREY  | 1/100   | 2.35      |



PRODUCTION MATERIAL: **PP**  
ΥΛΙΚΟ ΚΑΤΑΣΚΕΥΗΣ: **PP**

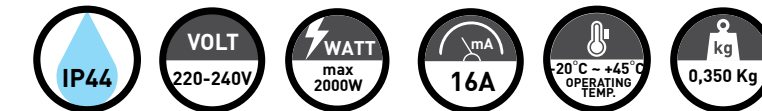

| BARCODE       | CODE      | WATT      | DIMENSIONS    | COLOR | PACKING | PRICE (€) |
|---------------|-----------|-----------|---------------|-------|---------|-----------|
| 5206139022776 | 147-16900 | max 2000W | 105x105x345mm | BLACK | 1/20    | 24.60     |

WALL/COLUMN LIGHTS • ΑΠΛΙΚΕΣ ΤΟΙΧΟΥ/ΚΟΛΩΝΑΚΙΑ ΔΑΠΕΔΟΥ



PRODUCTION MATERIAL: **METALLIC**  
ΥΛΙΚΟ ΚΑΤΑΣΚΕΥΗΣ: **ΜΕΤΑΛΛΟ**



| BARCODE       | CODE      | WATT                      | DIMENSIONS    | WEIGHT   | COLOR | PACKING | PRICE (€) |
|---------------|-----------|---------------------------|---------------|----------|-------|---------|-----------|
| 5207227063046 | 145-20606 | max 15W LED / 42W Halogen | 110x185x290mm | 0.882 kg | BLACK | 1/8     | 59.55     |
| 5207227063060 | 145-20607 | max 15W LED / 42W Halogen | 105x105x500mm | 0.860 kg | BLACK | 1/4     | 72.40     |
| 5207227063084 | 145-20608 | max 15W LED / 42W Halogen | 105x105x800mm | 1.080 kg | BLACK | 1/4     | 76.25     |

WALL/COLUMN LIGHTS • ΑΠΛΙΚΕΣ ΤΟΙΧΟΥ/ΚΟΛΩΝΑΚΙΑ ΔΑΠΕΔΟΥ



PRODUCTION MATERIAL: **METALLIC**  
ΥΛΙΚΟ ΚΑΤΑΣΚΕΥΗΣ: **ΜΕΤΑΛΛΟ**



| BARCODE       | CODE      | WATT                      | DIMENSIONS    | WEIGHT   | COLOR | PACKING | PRICE (€) |
|---------------|-----------|---------------------------|---------------|----------|-------|---------|-----------|
| 5207227062940 | 145-20601 | max 15W LED / 42W Halogen | 130x76x291mm  | 0.649 kg | BLACK | 1/16    | 46.35     |
| 5207227062964 | 145-20602 | max 15W LED / 42W Halogen | 142x100x800mm | 1.669 kg | BLACK | 1/4     | 83.35     |



PRODUCTION MATERIAL: **METALLIC**  
ΥΛΙΚΟ ΚΑΤΑΣΚΕΥΗΣ: **ΜΕΤΑΛΛΟ**

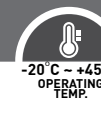

| BARCODE       | CODE      | WATT                      | DIMENSIONS   | WEIGHT   | COLOR | PACKING | PRICE (€) |
|---------------|-----------|---------------------------|--------------|----------|-------|---------|-----------|
| 5207227062988 | 145-20603 | max 15W LED / 42W Halogen | 95x136x240mm | 0.676 kg | BLACK | 1/12    | 42.85     |
| 5207227063008 | 145-20604 | max 15W LED / 42W Halogen | 95x95x500mm  | 0.784 kg | BLACK | 1/6     | 58.65     |
| 5207227063022 | 145-20605 | max 15W LED / 42W Halogen | 95x95x800mm  | 1.000 kg | BLACK | 1/4     | 64.25     |



PRODUCTION MATERIAL: **ALUMINIUM & POLYCARBONATE**  
ΥΛΙΚΟ ΚΑΤΑΣΚΕΥΗΣ: **ΑΛΟΥΜΙΝΙΟ & ΠΟΛΥΚΑΡΒΟΝΙΚΟ**

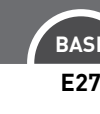

| BARCODE       | CODE      | WATT                      | DIMENSIONS    | WEIGHT   | COLOR     | PACKING | PRICE (€) |
|---------------|-----------|---------------------------|---------------|----------|-----------|---------|-----------|
| 5207227063275 | 145-20615 | max 12W LED / 42W Halogen | 100x160x230mm | 1,050 Kg | DARK GREY | 1/12    | 45.95     |
| 5207227063299 | 145-20616 | max 12W LED / 42W Halogen | 100x100x650mm | 1,950 Kg | DARK GREY | 1/6     | 76.35     |

WALL/COLUMN LIGHTS • ΑΠΛΙΚΕΣ ΤΟΙΧΟΥ/ΚΟΛΩΝΑΚΙΑ ΔΑΠΕΔΟΥ



PRODUCTION MATERIAL: **ALUMINIUM & PLASTIC**  
ΥΛΙΚΟ ΚΑΤΑΣΚΕΥΗΣ: **ΑΛΟΥΜΙΝΙΟ & ΠΛΑΣΤΙΚΟ**



| BARCODE       | CODE      | WATT                      | DIMENSIONS   | WEIGHT   | COLOR     | PACKING | PRICE (€) |
|---------------|-----------|---------------------------|--------------|----------|-----------|---------|-----------|
| 5207227062872 | 145-20612 | max 12W LED / 18W Halogen | 96x122x250mm | 0,500 Kg | DARK GREY | 1/8     | 41.35     |
| 5207227062889 | 145-20613 | max 12W LED / 18W Halogen | 96x96x450xmm | 0,800 Kg | DARK GREY | 1/4     | 64.35     |
| 5207227062896 | 145-20614 | max 12W LED / 18W Halogen | 96x96x700mm  | 1,200 Kg | DARK GREY | 1/4     | 77.20     |



PRODUCTION MATERIAL: **ALUMINIUM & PLASTIC**  
ΥΛΙΚΟ ΚΑΤΑΣΚΕΥΗΣ: **ΑΛΟΥΜΙΝΙΟ & ΠΛΑΣΤΙΚΟ**



| BARCODE       | CODE      | WATT                      | DIMENSIONS   | WEIGHT   | COLOR     | PACKING | PRICE (€) |
|---------------|-----------|---------------------------|--------------|----------|-----------|---------|-----------|
| 5207227062841 | 145-20609 | max 12W LED / 42W Halogen | 70x100x250mm | 0,450 Kg | DARK GREY | 1/10    | 39.85     |
| 5207227062858 | 145-20610 | max 12W LED / 42W Halogen | 95x95x450mm  | 0,680 Kg | DARK GREY | 1/4     | 63.75     |
| 5207227062865 | 145-20611 | max 12W LED / 42W Halogen | 95x95x700mm  | 1,100 Kg | DARK GREY | 1/4     | 76.15     |

WALL/COLUMN LIGHTS • ΑΠΛΙΚΕΣ ΤΟΙΧΟΥ/ΚΟΛΩΝΑΚΙΑ ΔΑΠΕΔΟΥ

PRODUCTION MATERIAL: **STAINLESS STEEL & PLASTIC**  
ΥΛΙΚΟ ΚΑΤΑΣΚΕΥΗΣ: **ΑΝΟΞΕΙΔΩΤΟΣ ΧΑΛΥΒΑΣ & ΠΛΑΣΤΙΚΟ**

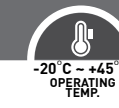

| BARCODE       | CODE      | WATT                      | DIMENSIONS    | WEIGHT   | COLOR | PACKING | PRICE (€) |
|---------------|-----------|---------------------------|---------------|----------|-------|---------|-----------|
| 5206139470201 | 154-56020 | max 10W LED / 28W Halogen | 76x76x400mm   | 0,580Kg  | INOX  | 1/20    | 20.55     |
| 5206139470218 | 154-56021 | max 10W LED / 28W Halogen | 131x145x350mm | 0,580Kg  | INOX  | 1/12    | 30.55     |
| 5206139470225 | 154-56022 | max 10W LED / 28W Halogen | 131x131x400mm | 0,750 Kg | INOX  | 1/8     | 29.60     |
| 5206139470232 | 154-56023 | max 10W LED / 28W Halogen | 131x131x800mm | 1,000Kg  | INOX  | 1/8     | 43.75     |



| BARCODE       | CODE      | WATT                      | DIMENSIONS     | WEIGHT   | COLOR | PACKING | PRICE (€) |
|---------------|-----------|---------------------------|----------------|----------|-------|---------|-----------|
| 5207227062797 | 145-20617 | max 12W LED / 42W Halogen | 230x170x230mm  | 0,850 Kg | BLACK | 1/8     | 36.80     |
| 5207227062803 | 145-20618 | max 12W LED / 42W Halogen | 230x170x230mm  | 0,850 Kg | BLACK | 1/8     | 36.80     |
| 5207227062810 | 145-20619 | max 12W LED / 42W Halogen | 170x170x300mm  | 0,910 Kg | BLACK | 1/8     | 36.80     |
| 5207227062827 | 145-20620 | max 12W LED / 42W Halogen | 170x170x1100mm | 1,400 Kg | BLACK | 1/4     | 58.80     |

WALL/COLUMN LIGHTS • ΑΠΛΙΚΕΣ ΤΟΙΧΟΥ/ΚΟΛΩΝΑΚΙΑ

PRODUCTION MATERIAL: **ALUMINIUM & GLASS**  
ΥΛΙΚΟ ΚΑΤΑΣΚΕΥΗΣ: **ΑΛΟΥΜΙΝΙΟ & ΓΥΑΛΙ**



154-55113  
154-55115



Color Box  
PACKING

| BARCODE       | CODE      | WATT                      | DIMENSIONS    | COLOR  | PACKING | PRICE (€) |
|---------------|-----------|---------------------------|---------------|--------|---------|-----------|
| 5206139461018 | 154-55101 | max 10W LED / 42W Halogen | 200x170x410mm | BLACK  | 1/12    | 23.45     |
| 5206139461032 | 154-55103 | max 10W LED / 42W Halogen | 200x170x410mm | BRONZE | 1/12    | 23.85     |
| 5206139461056 | 154-55105 | max 10W LED / 42W Halogen | 200x170x410mm | BLACK  | 1/12    | 23.25     |
| 5206139461070 | 154-55107 | max 10W LED / 42W Halogen | 200x170x410mm | BRONZE | 1/12    | 24.65     |
| 5206139461131 | 154-55113 | max 10W LED / 42W Halogen | 150x150x440mm | BLACK  | 1/10    | 23.25     |
| 5206139461155 | 154-55115 | max 10W LED / 42W Halogen | 150x150x440mm | BRONZE | 1/10    | 24.65     |

PRODUCTION MATERIAL: **ALUMINIUM & GLASS**  
ΥΛΙΚΟ ΚΑΤΑΣΚΕΥΗΣ: **ΑΛΟΥΜΙΝΙΟ & ΓΥΑΛΙ**



154-55133  
154-55135



Color Box  
PACKING

| BARCODE       | CODE      | WATT                      | DIMENSIONS    | COLOR  | PACKING | PRICE (€) |
|---------------|-----------|---------------------------|---------------|--------|---------|-----------|
| 5206139461216 | 154-55121 | max 10W LED / 42W Halogen | 160x220x340mm | BLACK  | 1/12    | 23.45     |
| 5206139461230 | 154-55123 | max 10W LED / 42W Halogen | 160x220x340mm | BRONZE | 1/12    | 23.85     |
| 5206139461254 | 154-55125 | max 10W LED / 42W Halogen | 300x220x305mm | BLACK  | 1/12    | 23.25     |
| 5206139461278 | 154-55127 | max 10W LED / 42W Halogen | 300x220x305mm | BRONZE | 1/12    | 24.65     |
| 5206139461339 | 154-55133 | max 10W LED / 42W Halogen | 200x200x357mm | BLACK  | 1/10    | 23.25     |
| 5206139461353 | 154-55135 | max 10W LED / 42W Halogen | 200x200x357mm | BRONZE | 1/10    | 24.65     |

PLASTIC GLOBES PMMA RECHARGEABLE • ΜΠΑΛΕΣ ΠΛΑΣΤΙΚΕΣ PMMA ΕΠΑΝΑΦΟΡΤΙΖΟΜΕΝΕΣ

PRODUCTION MATERIAL: **POLYETHYLENE**  
ΥΛΙΚΟ ΚΑΤΑΣΚΕΥΗΣ: **ΠΟΛΥΑΙΘΥΛΕΝΙΟ**

RGB WITH CONTROLLER  
RGB ME CONTROLLER

Battery Type: Lithium 2000mAh

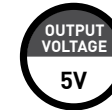
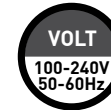

Brown Box  
with Sticker  
PACKING

| BARCODE       | CODE      | WATT | AMPERAGE | KELVIN | DIAMETER | COLOR | WEIGHT  | PACKING | PRICE (€) |
|---------------|-----------|------|----------|--------|----------|-------|---------|---------|-----------|
| 5207227062469 | 153-55350 | 5W   | 1A       | RBGWW  | ø300mm   | WHITE | 1,100Kg | 1/2     | 132.00    |
| 5207227062476 | 153-55351 | 5W   | 1A       | RBGWW  | ø400mm   | WHITE | 1,500Kg | 1/1     | 166.00    |
| 5207227062483 | 153-55352 | 5W   | 1A       | RBGWW  | ø500mm   | WHITE | 2,300Kg | 1/1     | 212.00    |



PLASTIC GLOBES PMMA • ΜΠΑΛΕΣ ΠΛΑΣΤΙΚΕΣ PMMA



PRODUCTION MATERIAL: **PMMA & ABS**  
ΥΛΙΚΟ ΚΑΤΑΣΚΕΥΗΣ: **PMMA & ABS**



BASE  
E27

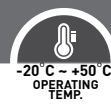

**Brown Box  
with Sticker  
PACKING**

| BARCODE       | CODE      | DIMENSIONS | COLOR | WEIGHT   | PACKING | PRICE (€) |
|---------------|-----------|------------|-------|----------|---------|-----------|
| 5207227011788 | 153-55300 | ∅200x200mm | OPAL  | 0,279 Kg | 1/18    | 11.65     |
| 5207227011818 | 153-55301 | ∅250x250mm | OPAL  | 0,420 Kg | 1/12    | 17.55     |
| 5207227011115 | 153-55302 | ∅300x300mm | OPAL  | 0,603 Kg | 1/8     | 24.45     |
| 5207227011153 | 153-55303 | ∅400x400mm | OPAL  | 1,131 Kg | 1/4     | 52.00     |
| 5207227011054 | 153-55305 | ∅200x200mm | HONEY | 0,279 Kg | 1/18    | 11.65     |
| 5207227011092 | 153-55306 | ∅250x250mm | HONEY | 0,420 Kg | 1/12    | 17.55     |
| 5207227011139 | 153-55307 | ∅300x300mm | HONEY | 0,603 Kg | 1/8     | 24.45     |
| 5207227011177 | 153-55308 | ∅400x400mm | HONEY | 1,131 Kg | 1/4     | 52.00     |

ACCESSORIES FOR PLASTIC GLOBES PMMA •  
ΑΞΕΣΟΥΑΡ ΓΙΑ ΜΠΑΛΕΣ ΠΛΑΣΤΙΚΕΣ PMMA



153-55310  
153-55311



153-55313



153-55312

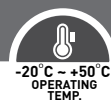

**Brown Box  
with Sticker  
PACKING**

| BARCODE       | CODE      | DIMENSIONS | MATERIAL | COLOR | WEIGHT   | PACKING | PRICE (€) |
|---------------|-----------|------------|----------|-------|----------|---------|-----------|
| 5207227011832 | 153-55310 | ∅60x1000mm | PVC      | BLACK | 1,100 Kg | 1/12    | 19.80     |
| 5207227011030 | 153-55311 | ∅60x1800mm | PVC      | BLACK | 1,980 Kg | 1/12    | 36.60     |
| 5207227011023 | 153-55313 | 160x120mm  | ABS      | BLACK | 0,065Kg  | 1/50    | 4.65      |
| 5207227011078 | 153-55312 | 160x170mm  | ABS      | BLACK | 0,186Kg  | 1/50    | 7.95      |





Ζητήστε να σας αποσταλλεί ο Νέος Κατάλογος της **MAGIC CHRISTMAS**.  
Πλήρης γκάμα κωδικών για κάθε κατηγορία ειδών Χριστουγεννιάτικου Διάκοσμου  
Βρείτε τον και σε Ψηφιακή μορφή στο:  
[www.eurolamp.gr](http://www.eurolamp.gr)

Ask for the new **MAGIC CHRISTMAS** Catalog to be sent to you.  
Complete range of codes for each category of Christmas decorations.  
Find it also in Digital form at:  
[www.eurolampglobal.com](http://www.eurolampglobal.com)



# EUROLAMP®

Pioneers in New Technology !

EUROLAMP A.B.E.E.  
Κάμπος ΔΙΑΒΑΤΩΝ / ΙΩΝΙΑ  
Τ.Θ. 515 / 570 08  
ΘΕΣΣΑΛΟΝΙΚΗ  
Τ: 2310 574802  
F: 2310 574919  
info@eurolamp.gr

[www.eurolamp.gr](http://www.eurolamp.gr)

EUROLAMP SA  
Kampos Diavata / IONIA  
P.O. 515 / 570 08  
THESSALONIKI - GREECE  
T: +30 2310 574802  
F: +30 2310 574919  
info@eurolamp.gr

[www.eurolampglobal.com](http://www.eurolampglobal.com)



 <https://www.facebook.com/eurolampSA/>

 [https://www.instagram.com/eurolamp\\_sa/](https://www.instagram.com/eurolamp_sa/)